

Readers and Credentials

How to Order Guide

PLT-02630, Rev E.0
February 2025



Copyright

© 2016 - 2025 HID Global Corporation/ASSA ABLOY AB. All rights reserved.

This document may not be reproduced, disseminated or republished in any form without the prior written permission of HID Global Corporation.

Trademarks

HID GLOBAL, HID, the HID Brick logo, the Chain Design, Asure ID, Corporate 1000, DuoProx, EntryProx, FARGO, FlexCard, FlexKey, FlexSmart, HID Linq, HID Mobile Access, HID ORIGO, HID Signo, iCLASS, iCLASS SE, ISOProx, EDGE, Edge EVO, MaxiProx, MicroProx, MiniProx, multiCLASS, pivCLASS, ProxCard, ProxKey, ProxPass, ProxPoint, ProxPro, Secure Identity Object, Seos, SIO, U90, are the trademarks or registered trademarks of HID Global, ASSA ABLOY AB, or its affiliate(s) in the US and other countries and may not be used without permission. All other trademarks, service marks, and product or service names are trademarks or registered trademarks of their respective owners.

MIFARE, MIFARE Classic, MIFARE DESFire, and MIFARE DESFire EV1, are registered trademarks of NXP B.V. and are used under license.

Contacts

For technical support, please visit: <https://support.hidglobal.com>.

What's new

Date	Description	Revision
February 2025	Adds the 40C model to HID Signo PIV Readers. Update to the Seos Card - 500 Slot Punch options.	E.0

A complete list of revisions is available in [Revision history](#).

Contents

Readers	8
Understanding HID Global Readers	9
What should I know about security keysets?.....	9
iCLASS SE Reader Standard Security Keysets	9
HID Signo Reader Credential Profiles	10
How can I order HID Elite configured readers?	10
How can I check the status of my order?	10
Selecting the Right Reader.....	11
HID Signo Readers	12
HID Signo Common and Popular orderable Part Numbers	14
HID Signo Accessories and Credentials.....	15
HID Signo Reader Configuration.....	16
HID Signo PIV Readers.....	17
HID Signo Biometric Reader.....	20
HID Signo Fingerprint Enrollment USB Reader	21
iCLASS SE Readers.....	22
iCLASS SE Readers - Seos Profile with Bluetooth Option.....	22
iCLASS SE Readers - Standard Profile with Bluetooth	24
iCLASS SE Readers - Standard Profile	26
iCLASS SE Express Reader.....	28
iCLASS SE Biometric Reader - Wiegand.....	30
iCLASS SE Readers - Magnetic Stripe.....	32
pivCLASS Readers - FIPS 201 Strong Authentication	34
pivCLASS Readers - Wiegand or OSDP.....	36
iCLASS SE U90 - UHF Long Range Reader	38
iCLASS SE Reader Accessories	39
iCLASS Reader Accessories.....	43
HID Proximity Readers.....	44
Prox Premier Reader – 900PX / 920PX	44
ProxPoint Plus Proximity Reader - 6005 / 6008	45
MiniProx Proximity Reader - 5365 / 5368.....	46
ProxPro Family Proximity Reader - 5455 / 5458 / 5355 / 5352 / 5358	47
ThinLine II Proximity Reader - 5395 / 5398	48
MaxiProx Proximity Reader - 5375	49
EntryProx Proximity Reader - 4045.....	50
HID Proximity Reader Accessories.....	51



- Indala Proximity Readers..... 53
 - Overview 53
 - Advantage Series Reader - ASR 620 53
 - FlexPass Reader - FP Arch / Keypad 54
 - FlexPass Accessories..... 55
- HID Mobile Access 56**
 - What is Mobile Access from HID?..... 57
 - Creating a HID Mobile Access User Account 57
 - Selecting the Right Mobile Access Subscription Type 58
 - HID Mobile Identities Part Numbers 58
 - Ordering Information – Readers for HID Mobile Access..... 59
 - Ordering Information – Mobile Identities Service 60
 - Preparing for Renewal 62
- Credentials 63**
 - Understanding HID Credentials 64
 - Can I configure my credential product online?..... 64
 - What should I know about security keysets?..... 64
 - How can I order HID Elite configured credentials?..... 64
 - How can I migrate from my current credential technology?..... 65
 - What is the difference between Seos, iCLASS SE and iCLASS credentials? 65
 - Credentials Marking..... 66
 - Credential Marking Technology..... 66
 - Understanding Credential Formats 66
 - Format Structure 66
 - What format do I need? 67
 - Common Formats..... 67
 - Format Compatibility..... 68
 - Indala Formats – Label Code 68
 - Long Formats (HID Prox) 68
 - Understanding Credential Programming..... 69
 - How do I complete the programming section correctly? 69
 - Examples..... 69
 - Eco Credentials 70
 - Seos Bamboo Card manufactured with sustainable FSC certified natural bamboo - 574 70



Seos Credentials 71

 Seos Card - 500 71

 Seos + iCLASS Card - 522 73

 Seos + Prox Card - 510 75

 Seos + iCLASS + Prox Card - 520 77

 Seos 8K with MIFARE Classic or DESFire EV1 Implementation – 5806/5906 79

 Seos Key Fob - 526 80

 Seos Clamshell - 565 81

 Seos Essential Card - 550 82

 Seos Essential + Prox Card - 551 83

iCLASS SE Credentials 85

 iCLASS SE Card - 300 / 305 85

 iCLASS SE + Prox Card - 315 87

 iCLASS SE Key - 325 89

 iCLASS SE Tag - 330 90

 iCLASS SE Clamshell Card - 335 91

 iCLASS SE + MIFARE Classic - 391 92

 iCLASS SE + MIFARE Classic + Prox Card - 396 94

iCLASS Credentials 97

 iCLASS Card - 200 / 210 97

 iCLASS + Prox Card - 212 99

 iCLASS Key - 205 101

 iCLASS Tag - 206 102

 iCLASS Clamshell Card - 208 103

 iCLASS + MIFARE Classic - 242 104

 iCLASS + MIFARE Classic + Prox Card - 262 106

UHF Credentials 109

 UHF Card - 600 109

 UHF + iCLASS Card - 601 110

 UHF + MIFARE Classic Card - 603 112

HID Proximity Credentials 114

 ProxCard II Card - 1326 114

 DuoProx II Card - 1336 / 1536 115

 ProxKey III Keyfob - 1346 117

 ISOProx II Card - 1386 / 1586 118

 ProxPass II Active Vehicle Identification Tag - 1351 119

 MicroProx Tag Proximity - 1391 120

Indala 125 kHz Credential.....	122
FPISO - FlexPass Imageable Card	123
FPCRD - FlexCard Standard Card	124
FPTAG - FlexTag	125
FPKEY - FlexKey Keytag	126
FlexPass Formats.....	127
MIFARE DESFire® Credentials.....	128
MIFARE DESFire EV3 Card: High Security Profile – 802	129
MIFARE DESFire EV3 Card: Compatibility Profile – 801	130
MIFARE DESFire EV3 Card: Custom Profile - 800	132
MIFARE DESFire EV3 + Prox Card: High Security Profile – 812.....	134
MIFARE DESFire EV3 + Prox Card: Compatibility Profile - 811	136
MIFARE DESFire EV3 + Prox: Custom Profile - 810.....	138
MIFARE DESFire EV3 + iCLASS 32k Technology Card: High Security Profile - 822	140
MIFARE DESFire EV3 + iCLASS Card: Compatibility Profile - 821	142
MIFARE DESFire EV3 + iCLASS 32K Card: Custom Profile - 820	144
MIFARE DESFire EV3 + iCLASS 32K + Prox Card: High Security Profile - 832	146
MIFARE DESFire EV3 + iCLASS + Prox Card: Compatibility Profile - 831.....	148
MIFARE DESFire EV3 + iCLASS 32k + Prox Card: Custom Profile - 830.....	150
MIFARE Credentials	152
MIFARE Classic Card - 340 / 345 / 1430 / 1440 / 1436 / 1446.....	152
MIFARE Classic + Prox Card - 350 / 355 / 1431 / 1441 / 1437 / 1447.....	154
MIFARE Classic Keyfob - 1434 / 1444	156
MIFARE Classic Adhesive Tag - 1435	157
CP1000 iCLASS SE Encoder	158
iCLASS SE Encoder Summary.....	158
iCLASS SE Encoder - How Does it Work?	158
iCLASS SE Encoder Ordering Basics.....	158
Step 1: Hardware	159
Step 2: Select Additional Credential Credits	160
Genuine HID Technology Credential Credits – Part Tables	160
Third Party HID Technology Credential Credits – Part Tables	161
Step 3: Select Additional Formats.....	162
How to order FRMT-J1 (HID open, tracked or OEM format)	162
How to order FRMT-J2 (Corporate 1000 format)	162
Step 4: Select Additional Keysets	163
Step 5: Encoder Order Form	164

Embeddable Credentials	165
Overview.....	165
What is an Embeddable Card?.....	165
Why do I need an Embeddable Card?	165
Can I Configure my Embeddable Credential Product Online?.....	165
Credentials Marking	165
Embedding Capability.....	165
Embeddable Seos Credentials	166
Seos Embeddable Card - 501	166
Seos + Prox Embeddable Card - 511	168
Embeddable iCLASS SE Credentials.....	170
iCLASS SE Embeddable Card - 301	170
iCLASS SE + Prox Embeddable Card - 311	172
iCLASS SE + Other HF Embeddable Card - 392.....	174
iCLASS SE + Other 13.56MHz + Prox Embeddable Card - 397.....	176
Embeddable iCLASS Credentials.....	179
iCLASS Embeddable Card - 211	179
iCLASS + Prox Embeddable Card - 213.....	181
iCLASS + Other HF Embeddable Card - 243	183
iCLASS + Other 13.56 MHz + Prox Embeddable Card - 263.....	185
Embeddable HID Proximity Credentials.....	188
Smart ISOProx® II Card - 1597	188
Smart DuoProx® II Card - 1598	190
Embeddable MIFARE Classic and MIFARE DESFire Credentials	192
MIFARE Embeddable Card - 345 / 1436 / 1446.....	192
MIFARE DESFire Embeddable Card - 375 / 1456	194
MIFARE + Prox Embeddable Card - 355 / 1437 / 1447	196
MIFARE DESFire + Prox Embeddable Card - 385 / 1457.....	198

Section 01

Readers

Understanding HID Global Readers

What should I know about security keysets?

HID Signo™, iCLASS SE® readers and Seos®/iCLASS SE credentials offer two keyset security schemes, HID Elite and Standard.

The **HID Elite Security Program** supports a unique keyset on a per site/company basis.

The keyset governs a variety of keys, including:

- Media (credential) keys for iCLASS SE, SIO®-encoded iCLASS, MIFARE Classic (SIO) and MIFARE DESFire EV1 (SIO) credentials.
- SIO authenticity and privacy keys (media independent).
- Configuration programming keys (for programming reader configuration, also media independent).

When utilizing HID's standard key set for the above keys, all standard keyed credentials work with all standard keyed readers. Additionally, any Standard Security configuration card configures a Standard Security reader (only accomplished during the first five (5) seconds after reader powers-up).

Conversely, when utilizing the HID Elite program, only site/company specific HID Elite credentials and configuration cards work with matching readers.

The **Standard Security Program** provides universal keysets that offer maximized compatibility by keying readers and cards with matching security for use in the general population. This allows for maximized compatibility because readers and cards are not keyed on a per site/company basis but rather all keyed the same. This offers the advantage to the integrator as a standard stock of readers and cards will interoperate for a variety of sites/companies, rather than needing different stocks of readers and cards for each individual site.

iCLASS SE Reader Standard Security Keysets

iCLASS SE readers provide two Standard Security Keysets that offer compatibility with the following credentials:

Standard Security Keyset	Compatibility with these Credentials
Version 1	<ul style="list-style-type: none"> • Seos (+ Prox) • iCLASS SE (+ Prox) • iCLASS SR (+ Prox) • iCLASS (+ Prox) • MIFARE Classic (+ Prox) • MIFARE DESFire EV1 (+ Prox)
Version 2	<ul style="list-style-type: none"> • Seos (+ Prox) • iCLASS SE (+ Prox) • MIFARE Classic (+ Prox) • MIFARE DESFire EV1 (+ Prox)



HID Signo Reader Credential Profiles

HID Signo Readers are available with the following credential profile options.

Communication Type	NFC/ BLE	High Frequency											Low Frequency					
		Credentials Technologies Supported	Seos (Mobile IDs via NFC/BLE)	Seos	iCLASS SE	iCLASS SR	iCLASS	MIFARE DESFire EV1 / EV2/EV3 (SIO)	MIFARE Classic (SIO)	MIFARE DESFire EV1 / EV2/EV3 (CSN)	MIFARE Classic (CSN)	MIFARE DESFire EV1 / EV2/EV3 (Custom Data)	MIFARE Classic (Custom Data)	FeliCa IDm	CEPAS (CAN or UID)	125kHz HID Proximity	125kHz Indata Proximity	125kHz EM4102 Proximity
Regular Options	<input type="checkbox"/> 00 - Standard Profile	•	•	•	•	•	•	•	•	•	•	•	•	•	•	•	•	•
	<input type="checkbox"/> 01 - Seos Profile	•	•	–	–	–	–	–	–	–	–	–	–	–	–	–	–	–
	<input type="checkbox"/> 02 - Smart Profile	•	•	•	•	•	•	•	•	•	•	•	•	•	•	•	•	•
	<input type="checkbox"/> 03 - Custom Profile	•	•	•	•	•	•	•	•	•	•	•	•	•	•	•	•	•
Priority Options	<input type="checkbox"/> T0 - Priority Standard Profile	•	•	•	•	•	•	•	•	•	•	•	•	•	•	•	•	•
	<input type="checkbox"/> T1 - Priority Seos Profile	•	•	–	–	–	–	–	–	–	–	–	–	–	–	–	–	–
	<input type="checkbox"/> T2 - Priority Smart Profile	•	•	•	•	•	•	•	•	•	•	•	•	•	•	•	•	•
	<input type="checkbox"/> T3 - Priority Custom Profile	•	•	•	•	•	•	•	•	•	•	•	•	•	•	•	•	•

• Supported – Not supported

How can I order HID Elite configured readers?

- Direct customers of HID must be authorized to purchase components with HID Elite keys. If you are not authorized, you must have the key owner authorize you through the Authorization form.
- See <https://www.hidglobal.com/solutions/elite-key>
- Ensure the HID Elite flag is set in the part number (of readers, credentials and programming cards).
- All Purchase Orders for HID Elite components must be ordered with the HID Elite reference number (starts with ICE or MOB).

How can I check the status of my order?

- To check order status, go to: <https://orderstatus.hidglobal.com/CCCOrderStatus>

Selecting the Right Reader

In order to make sure our customers benefit from the latest and most secure technology, based on their needs and current situation, HID Global offers a reader product guidance. Follow the suggested route below based on your current credential population, to see what reader solution is recommended by HID Global.

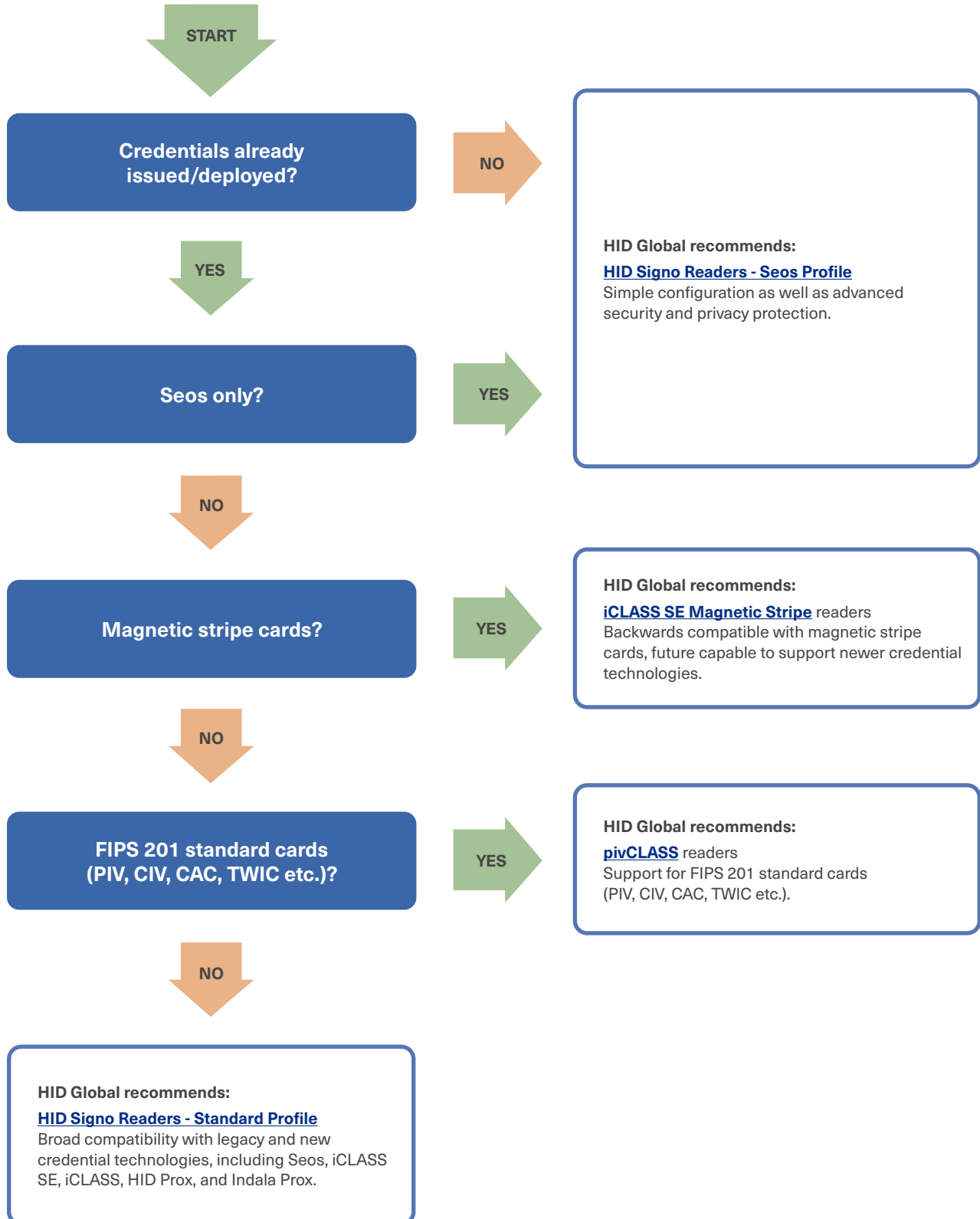

HID Signo Readers

Application: HID Signo is the signature line of physical access control readers from HID Global. The versatility, performance and connected capabilities of HID Signo Readers set a new industry benchmark for the most highly adaptable, interoperable and secure approach to electronic access control.

Technologies Supported: Wide variety of contactless low and high frequency credentials, plus HID Mobile Access® Mobile IDs via NFC and/or Bluetooth LE.

Select models are available without Bluetooth LE functionality.

Follow the steps below to determine a standard configuration HID Signo Reader part number.



1. Select hardware option (select one model)



- 20** - Designed for applications requiring a narrow card reader.



- 20K** - Designed for applications requiring a narrow reader with 2 x 6 capacitive keypad.



- 40** - Designed for applications requiring switch mounting.



- 40K** - Designed for applications requiring wall switch mounting with 3 x 4 capacitive keypad.



- 40T** - Designed for applications requiring wall switch mounting with 3 x 4 mechanical keypad. (Only available with terminal strip connection)¹

Wiring Connection (select one option)

- N** - Pigtail
 T - Terminal Strip

Body Color

- K** - Black
 W - White

Trim/Mounting Plate Color

- S** - Silver

A black trim/mounting plate is available as an accessory item at an additional cost. Please see accessories list below.

Factory Feature Block (option)

- Blank** - Default
 1 - No Bluetooth LE functionality (example 20TKS1)²



2. Select credential profile (select one option)

	Communication Type	NFC/ BLE	High Frequency											Low Frequency			
	Credentials Technologies Supported	Seos® (Mobile IDs via NFC/BLE)	Seos	iCLASS SE®	iCLASS SR	iCLASS®	MIFARE DESFire EV1 / EV2/EV3 (SIO)	MIFARE Classic (SIO)	MIFARE DESFire EV1 / EV2/EV3 (CSN)	MIFARE Classic (CSN)	MIFARE DESFire EV1 / EV2/EV3 (Custom Data)	MIFARE Classic (Custom Data)	FeliCa IDm	CEPAS (CAN or UID)	125kHz HID Proximity®	125kHz Indala Proximity	125kHz EM4102 Proximity
Regular Options	<input type="checkbox"/> 00 - Standard Profile	•	•	•	•	•	•	•	•	•	•	•	•	•	•	•	•
	<input type="checkbox"/> 01 - Seos Profile	•	•	-	-	-	-	-	-	-	-	-	-	-	-	-	-
	<input type="checkbox"/> 02 - Smart Profile	•	•	•	•	•	•	•	-	-	-	-	-	-	-	-	-
	<input type="checkbox"/> 03 - Custom Profile	•	•	•	•	•	•	•	•	•	•	•	•	•	•	•	•
Priority Options³	<input type="checkbox"/> T0 - Priority Standard Profile	•	•	•	•	•	•	•	•	•	-	-	-	-	-	-	-
	<input type="checkbox"/> T1 - Priority Seos Profile	•	•	-	-	-	-	-	-	-	-	-	-	-	-	-	-
	<input type="checkbox"/> T2 - Priority Smart Profile	•	•	•	•	•	•	•	-	-	-	-	-	-	-	-	-
	<input type="checkbox"/> T3 - Priority Custom Profile	•	•	•	•	•	•	•	•	•	•	•	•	•	-	-	-

• Supported - Not supported

Note:

- HID Signo Mechanical Keypad Readers are only available with a terminal strip wiring connection.¹
- HID Signo Readers without Bluetooth LE functionality via Factory Feature Block are only available when ordered with a configuration ID (non -000000 part numbers).²
- Ordering HID Signo readers without Bluetooth LE functionality can limit the in field upgrade capability. The HID Reader Manager App can be used to configure (Android only), and firmware upgrade and configuration can be carried out via HID Linq™ with direct USB connection.²
- HID Signo Mechanical Keypad Readers are only available in 00,01,02, and 03 profiles (not available with Priority Profiles).³

3. Select configuration option

	Credential Profile	Default Reader Configuration	Flexible Default Reader Configuration*		
			Key Input only (ICE or MOB)	Key (ICE or MOB) + Indala Format Input	Indala Format Input only
Wiegand	Standard	000000	001TCX	001UX8	001UX4
	Seos	000000	001UXB	-	-
	Smart	000000	001UXD	-	-
	Custom	000000	00AUY2	00AUYG	00AUY8
OSDP V1	Standard	0104UB	0065H5	0065H7	0065H6
	Seos	0104U3	0065H8	-	-
	Smart	0104TV	0065H9	-	-
	Custom	0104TL	00AV24	00AV2C	00AV29
OSDP V2	Standard	00BMD	0063HH	0063HN	0063HQ
	Seos	00BMMF	0063HK	-	-
	Smart	00BMMG	0063HL	-	-
	Custom	00BMMJ	00AV2N	00AV31	00AV2Y

***Flexible Default Reader Configuration** options offer the same reader settings as the Default Reader Configuration, however they also allow for HID Elite keys (ICE), Mobile keys (MOB) and/or Indala formats to be provided at the time of order. This provides the option for HID Partners to reduce the number of HID Signo part numbers they need to support. A new configuration ID with this information preloaded will also be made available on the reader and documentation to simplify repeat ordering.

- Idle LED color is RED, flash GREEN on card read (see note)
- Tamper enabled
- Keypad 4-bit burst, Keypad backlight RED (keypad readers only)
- Visual Impaired Mode enabled
- Velocity Check disabled and Intelligent Power Management mode disabled
- Wiegand, OSDP V1, or OSDP V2 controller communication

For any other configuration, including non-standard credential configurations, please use the interactive online [HID Product Configurator](#). An example of a “non-standard” credential configuration would be where you would like to order a Standard Profile HID Signo Reader with Indala and CSN credential read capability disabled.

Note:

- No changes to reader configuration IDs are required when opting for the new counterpart priority credential profile. For example, if you are using “001TCX” with a Seos (01) profile reader, you can continue using the same configuration ID with a Priority Seos Profile (T1) reader.
- HID Signo white reader default, Idle LED color is Blue, flash GREEN on card read.

4. Enter the numbers/letters from the selections above into the following table

Assemble your selections from Step 1 to 3.

	Reader Model	Wiring Connection	Body Color	Trim Color		Credential Profile		Configuration Option
Example	20	T	K	S	–	00	–	000000
Final Part Number			K	S	–		–	000000

5. Place an order

To place an order for HID Signo readers, authorized channel partners may submit a purchase order to HID Global Customer Service at <https://www.hidglobal.com/customer-service>

HID Signo Common and Popular orderable Part Numbers

HID Signo part numbers below provide full compatibility with the associated iCLASS SE / multiCLASS SE readers. Seos and smart profiles provide focused credential compatibility, please refer to the original reader configuration to determine the appropriate profile.

iCLASS SE / multiCLASS SE Part Number	Compatible HID Signo Reader Part Number (pigtail)	iCLASS SE / multiCLASS SE Part Number	Compatible HID Signo Reader Part Number (terminal strip)
900NTNNEK00000 (R10) 900PTNNEK00000 (RP10) 910NTNNEK00000 (R15) 910PTNNEK00000 (RP15)	Signo 20 20NKS-00-000000	900NTNTEK00000 (R10) 900PTNTEK00000 (RP10) 910NTNTEK00000 (R15) 910PTNTEK00000 (RP15)	Signo 20 20TKS-00-000000
920NTNNEK00000 (R40) 920PTNNEK00000 (RP40)	Signo 40 40NKS-00-000000	920NTNTEK00000 (R40) 920PTNTEK00000 (RP40)	Signo 40 40TKS-00-000000
921NTNNEK00000 (RK40) 921PTNNEK00000 (RPK40)	Signo 40 Keypad 40KNKS-00-000000	921NTNTEK00000 (RK40) 921PTNTEK00000 (RPK40)	Signo 40 Keypad 40KTKS-00-000000 40TTKS-00-000000
921NTNNEK00000 (RK40) 921PTNNEK00000 (RPK40)	Signo 20 Keypad 20KNKS-00-000000	921NTNTEK00000 (RK40) 921PTNTEK00000 (RPK40)	Signo 20 Keypad 20KTKS-00-000000
Note: HID Signo 20K reader is mullion mount with 2 x 6 keypad		Note: HID Signo 20K reader is mullion mount with 2 x 6 keypad	

HID Signo Accessories and Credentials

Need accessories or compatible credentials? HID Signo readers support (depending on configuration) the following credentials:

- Mobile IDs
- Seos
- iCLASS SE
- iCLASS
- HID Prox™
- Indala Proximity
- MIFARE DESFire
- MIFARE Classic

Wall Spacers		Part Number
	Signo 20/20K Reader 0.5 Inch Spacer, Black	20-K-05
	Signo 20/20K Reader, 0.5 Inch Spacer, Silver	20-S-05
	Signo 20/20K Reader, 0.5 Inch Spacer, White	20-W-05
	Signo 20/20K Reader, 1 Inch Spacer, Black	20-K-10
	Signo 20/20K Reader, 1 Inch Spacer, Silver	20-S-10
	Signo 20/20K Reader, 1 Inch Spacer, White	20-W-10
	Signo 40/40K Reader, 0.5 Inch Spacer, Black	40-K-05
	Signo 40/40K Reader, 0.5 Inch Spacer, Silver	40-S-05
	Signo 40/40K Reader, 0.5 Inch Spacer, White	40-W-05
	Signo 40/40K Reader, 1 Inch Spacer, Black	40-K-10
	Signo 40/40K Reader, 1 Inch Spacer, Silver	40-S-10
	Signo 40/40K Reader, 1 Inch Spacer, White	40-W-10

0.5 Inches = 1.27 cm
1 Inch = 2.54 cm

Mounting Plate/Trim Color		Part Number
	Signo 20 Reader Mounting Plate, Black	20-K-MP
	Signo 20 Reader Mounting Plate, Silver	20-S-MP
	Signo 20 Reader Mounting Plate, White	20-W-MP
	Signo 20K Reader Mounting Plate, Black	20KT-K-MP
	Signo 20K Reader Mounting Plate, Silver	20KT-S-MP
	Signo 20K Reader Mounting Plate, White	20K-W-MP
	Signo 40 Reader Mounting Plate, Black	40-K-MP
	Signo 40 Reader Mounting Plate, Silver	40-S-MP
	Signo 40 Reader Mounting Plate, White	40-W-MP
	Signo 40K Reader Mounting Plate, Black	40KT-K-MP
	Signo 40K Reader Mounting Plate, Silver	40KT-S-MP
	Signo 40K Reader Mounting Plate, White	40KT-W-MP
Signo 40/40K Adaptor Plate, Black	40-K-AP	

HID Signo Reader Configuration

HID Signo Readers are designed to be configured and upgraded using the HID Reader Manager mobile application and HID Linq cloud, providing flexible upgrade solutions.

HID Linq: <https://www.hidglobal.com/products/linq>

The App Store (Apple devices)



Google Play (Android devices)



HID Signo PIV Readers

Application: HID Signo PIV Readers are hardware variants of the flagship HID Signo line and are designed to support the authentication of FIPS 201 compliant smart cards such as PIV, PIV-I, CIV, CAC, FRAC, and TWIC in both government and non-government environments.

HID Signo PIV Readers are BAA Complaint and FICAM Certified. You do not need to be pivCLASS certified to resell HID Signo PIV Readers.

If you are connecting the Signo PIV Reader directly to a panel or intelligent controller for use with either Wiegand or OSDP (PAM and EA are supported with Signo PIV), use this page to construct the appropriate part number.

Follow the steps below to determine a standard configuration HID Signo PIV Reader part number.



1. Select hardware option (select one model)



20 - Designed for applications requiring a narrow card reader.



20K - Designed for applications requiring a narrow reader with 2 x 6 capacitive keypad.



40 - Designed for applications requiring switch mounting.



40K - Designed for applications requiring wall switch mounting with 3 x 4 capacitive keypad.



40C - Designed for applications requiring contact read.

Federal Identity, Credential, and Access Management (FICAM) & Buy American Act (BAA) Certified Hardware

H - BAA

Wiring Connection (select one option)

N - Pigtail

T - Terminal Strip

Body Color

K - Black

Trim/Mounting Plate Color

S - Silver

K - Black (40C only)

A black trim/mounting plate is available as an accessory item at an additional cost. Please see accessories list below.

Factory Feature Block (option)

Blank - Default

1 - No Bluetooth LE functionality (example 20HTKS1)*

2. Select credential profile

HID Signo PIV Readers are only available with the Custom Credential Profile, which includes CHUID credential read support. Bluetooth (BLE) is disabled by default on all HID Signo PIV Readers.

Communication	NFC/ BLE	High Frequency											Low Frequency				
Credentials Supported	Seos (Mobile IDs via NFC/BLE)	Seos	iCLASS SE	iCLASS SR	iCLASS	MIFARE DESFire EV1/ EV2 (SIO)	MIFARE Classic (SIO)	MIFARE DESFire EV1/ EV2 (CSN)	MIFARE Classic (CSN)	MIFARE DESFire EV1/ EV2 (Custom Data)	MIFARE Classic (Custom Data)	FeliCa Idm	CEPAS (CAN or UID)	FIPS-201 CHUID	125kHz HID Proximity	125kHz Indala Proximity	125kHz EM4102 Proximity
<input type="checkbox"/> 03 - Custom Profile	•	•	•	•	•	•	•	•	•	•	•	•	•	•	•	•	•

• Supported

Note:

- HID Signo Readers without Bluetooth LE functionality via Factory Feature Block are only available when ordered with a configuration ID (non -000000 part numbers).*
- Ordering HID Signo readers without Bluetooth LE functionality can limit the in field upgrade capability. The HID Reader Manager App can be used to configure (Android only), and firmware upgrade and configuration can be carried out via HID Linq with direct USB connection.*

3. Select configuration option

Credential Profile	Prox Disabled	Prox Enabled	PAM mode ON
CUSTOM	00059X	0004XR	007CP5

- Bluetooth (BLE) disabled
- OSDP Transparent Mode enabled
- Idle LED color is RED, flash GREEN on card read
- Tamper enabled
- Keypad 4-bit burst, Keypad backlight RED (keypad readers only)
- Visual Impaired Mode enabled
- Velocity Check disabled and Intelligent Power Management mode disabled

For any other configuration, including non-standard credential configurations, please work with your local HID representative. An example of a “non-standard” credential configuration would be where you would like to order a HID Signo PIV Reader with Indala and CSN credential read capability disabled.

4. Enter the numbers/letters from the selections above into the following table

Assemble your selections from Step 1 to 3.

	Reader Model	BAA	Wiring Connection	Body Color	Trim Color	FFB/No BLE*		Credential Profile		Configuration Option
Example	40K	H	T	K	S	1	-	03	-	0004XR
Final Part Number		H		K	S		-	03	-	

*Enter “1” for FFB/No BLE.

5. Place an order

To place an order for HID Signo Readers, authorized channel partners may submit a purchase order to HID Global Customer Service at <https://www.hidglobal.com/customer-service>

HID Signo PIV Reader common and popular orderable part numbers

HID Signo PIV Reader part numbers below provide full compatibility with the associated pivCLASS readers.

Compatible HID Signo PIV Reader Part Number (pigtail)	pivCLASS Reader Part Number	Compatible HID Signo PIV Reader Part Number (terminal strip)
Signo PIV 20 20HNKS-03-00059X	R10 900NH(R/P)TEKxyyyy	Signo PIV 20 20HTKS-03-00059X
Signo PIV 40 40HNKS-03-00059X	R40 920NH(R/P)TEKxyyyy	Signo PIV 40 40HTKS-03-00059X
Signo PIV 20K / Signo PIV 40K 20KHNS-03-00059X 40KHNS-03-00059X	RK40 921NH(R/P)TEKxyyyy	Signo PIV 20K / Signo PIV 40K 20KHTKS-03-00059X 40KHTKS-03-00059X
Signo PIV 20 20HNKS-03-0004XR	RP10 900PH(R/P)TEKxyyyy	Signo PIV 20 20HTKS-03-0004XR
Signo PIV 40 40HNKS-03-0004XR	RP40 920PH(R/P)TEKxyyyy	Signo PIV 40 40HTKS-03-0004XR
Signo PIV 20K / Signo PIV 40K 20KHNS-03-0004XR 40KHNS-03-0004XR	RPK40 921PH(R/P)TEKxyyyy	Signo PIV 20K / Signo PIV 40K 20KHTKS-03-0004XR 40KHTKS-03-0004XR
Note: HID Signo 20K reader is mullion mount with 2 x 6 keypad		Note: HID Signo 20K reader is mullion mount with 2 x 6 keypad

HID Signo PIV Reader configuration

HID Signo PIV Readers can be configured using an Android smartphone with the HID Reader Manager™ application, a tool that provides powerful configuration and upgrade capabilities through a convenient smart phone application.

- Notes:**
- An Android device is needed to enable BLE via NFC, BLE is then used to configure HID Signo PIV Readers via HID Reader Manager, after configuration is complete BLE can also be disabled with the tool.
 - Configuration of CHUID output formats is currently not supported in HID Reader Manager v1.8.0. – this feature will be added in a future version.

Google Play (Android devices)



HID Signo Biometric Reader

Application: The HID Signo Biometric Reader is designed for “real-world” applications, where people have wet, dry, dirty or worn fingerprints. Using patented multispectral imaging technology, it is capable of capturing and reading fingerprints that other devices cannot.

Technologies Supported: Wide variety of contactless high frequency credentials, plus HID Mobile Access® Mobile IDs via NFC and Bluetooth Smart.



1. Select hardware option



25B - Designed for door applications requiring a small footprint card reader.

Wiring Connection

N - Pigtail

Body Color

K - Black

Trim/Mounting Plate Color

S - Silver

3. Select credential profile

Communication	NFC/BLE	High Frequency					
Credentials Supported	Seos (Mobile IDs)	Seos	iCLASS SE	iCLASS SR	iCLASS	MIFARE DESFire EV1/ EV2/EV3 (CSN)	MIFARE Classic (CSN)
<input checked="" type="checkbox"/> 10 - Biometric Reader Credential Profile	•	•	•	•	•	•	•

4. Select configuration option

- 000000 – Standard Configuration:
- Idle LED color is RED, flash GREEN on card read
 - Liveness detection enabled
 - Template on Card Mode Enabled
 - Tamper Enabled
 - Wiegand Enabled

Currently this is the only configuration option available from the factory. HID Biometric Manager is available to download for free with each device. This on-prem server based software can be used to configure and manage the reader, including firmware updates over the network and loading MOB or Elite keys in the field.

5. Final orderable SKU

Assembling the selections from Step 1 to 3.

Final Part Number: 25BNKS-10-000000

	Reader Model	Wiring Connection	Body Color	Trim Color		Credential Profile		Configuration Option
Final Part Number	25B	N	K	S	–	10	–	000000

To place an order for HID Signo readers, authorized channel partners may submit a purchase order to HID Global Customer Service at: <http://www.hidglobal.com/customer-service>



HID Signo Fingerprint Enrollment USB Reader

Application: HID multi-spectral imaging technology in a compact footprint. Multi-spectral imaging captures surface and subsurface biometric details, no matter the quality of the fingerprint (extra dry, wet, oily, dirty, aged, and damaged), enabling a superior user experience without sacrificing security.

The HID Signo Fingerprint Enrollment USB Reader offers a low cost pathway to decentralized enrollment. Users will no longer have to travel to a specific location to be enrolled in the system, accelerating set up times and lowering costs with a superior user experience.

Image	Part Number	Compatible Reader
	SIGNO-B-USB	To be used with HID Signo Biometric 25B and iCLASS SE RB25F readers

iCLASS SE Readers

Note: See “Selecting the Right Reader” on page 10 for guidance.

iCLASS SE Readers - Seos Profile with Bluetooth Option

Application: Designed to instill confidence with advanced security and privacy protection.

Technologies Supported: Seos, HID Prox, and HID Mobile Access Mobile IDs via NFC and/or Bluetooth Smart.



1. Select one option from each of the following sections to construct part number

Reader Model (select one model)

- | | |
|---|---|
|  <input type="checkbox"/> 900 - Model R10 - Designed for door applications requiring a small footprint card reader. |  <input type="checkbox"/> 910 - Model R15 - Designed for door applications requiring a mullion style mounting. |
|  <input type="checkbox"/> 920 - Model R40 - Designed for door applications requiring standard wall switch mounting. |  <input type="checkbox"/> 921 - Model RK40 - Designed for door applications requiring standard wall switch mounting and keypad input. |

125 kHz Credential Support (select one option)

- N** - No 125 kHz support
- P** - Support for HID Prox

13.56 MHz and Bluetooth credential support (select one option)

- S** - Supports Seos cards, and Mobile IDs via NFC.
- B** - Supports Seos cards, and Mobile IDs via NFC and Bluetooth Smart.

Controller Communication

- N** - Wiegand
- P** - OSDP

Wiring Connection (select one option)

- N** - Pigtail
- T** - Terminal strip

Hardware Revision

- E** - Revision E

Color

- K** - Black

Keypad (select one option)

- 2** - Standard and Mobile-Ready - supports Seos credentials with standard keys. Prepared to support HID Mobile Access, but lacks the personalized configuration to read an organization’s specific Mobile IDs. This configuration can be ordered at any time but will require field activation after the organization has completed registration for HID Mobile Access.
- E** - HID Elite and Mobile-Enabled - supports Seos credentials and Mobile IDs. Fully activated and personalized to support an organization’s specific Mobile IDs. These readers can only be ordered after the organization has completed registration for either HID Elite or HID Mobile Access. If HID Elite reference (ICE) is given at time of order, only Seos credentials with HID Elite keys are supported. If Mobile Reference (MOB) is given at time of order, only Seos credentials with standard keys are supported.

Configuration Settings

0000 - Standard configuration. All iCLASS SE Readers - Seos Profile ship with the following standard configuration:

- LED normally red, LED flashes green and beeps on card read.
- Keypad output is 4-bit (if keypad reader).
- Wiegand only, for OSDP a non-standard configuration will be required.

Non-standard configuration can be applied at the time of installation using the configuration card accessories listed on the next page.

2. Enter the numbers/letters from the selections above into the table below

The resulting "Final Part Number" is used when ordering readers.

	Reader Model	125 kHz	13.56 MHz	Communication	Wiring	HW Rev	Color	Keypad	Config Setting
Example	920	N	S	N	T	E	K	E	0000
Final Part Number				N		E	K		0000

3. Place an order

To place an order for this product, authorized channel partners may submit a purchase order to HID Global Customer Service.

Contact information is available at: <http://www.hidglobal.com/customer-service>

Need credentials? Credentials supported by this reader model includes (depending on options chosen above):

- [Mobile IDs](#)
- [Seos](#)
- [Seos + Prox](#)

iCLASS SE Reader - Seos Profile Configuration Cards

Config Card Number	Description
SE-SEOS-2-CRD0	iCLASS SE Seos Profile readers configuration config cards - Standard keys (2) - all cards (21 cards)
SE-SEOS-E-CRD0	iCLASS SE Seos Profile readers configuration config cards - HID Elite keys - all cards (21 cards)
SE-SEOS-2-CRD1	iCLASS SE Seos Profile readers configuration config cards - Standard keys (2) - Seos and Prox settings (4 cards) Contains cards used to change the priority setting of Seos and Prox technologies
SE-SEOS-2-CRD2	iCLASS SE Seos Profile readers configuration config cards - Standard keys (2) - Panel output settings (3 cards) Contains cards used to change the reader output between Wiegand and OSDP
SE-SEOS-2-CRD3	iCLASS SE Seos Profile readers configuration config cards - Standard keys (2) - Audio visual settings (13 cards) Contains cards used to change behavior of reader LED and beeper
SE-SEOS-2-CRD4	iCLASS SE Seos Profile readers configuration config cards - Standard keys (2) - keypad format settings (4 cards) Contains cards used to change output settings of keypad reader models
SE-SEOS-E-CRD1	iCLASS SE Seos Profile readers configuration config cards - HID Elite keys - Seos and Prox settings (4 cards) Contains cards used to change the priority setting of Seos and Prox technologies
SE-SEOS-E-CRD2	iCLASS SE Seos Profile readers configuration config cards - HID Elite keys - Panel output settings (3 cards) Contains cards used to change the reader output between Wiegand and OSDP
SE-SEOS-E-CRD3	iCLASS SE Seos Profile readers configuration config cards - HID Elite keys - Audio visual settings (13 cards) Contains cards used to change behavior of reader LED and beeper
SE-SEOS-E-CRD4	iCLASS SE Seos Profile readers configuration config cards - HID Elite keys - keypad format settings (4 cards) Contains cards used to change output settings of keypad reader models

Note: The above configuration cards are only intended for use with iCLASS SE Reader - Seos profile.

iCLASS SE Readers - Standard Profile with Bluetooth

Application: Designed to ensure compatibility with legacy credentials and capability to support the future.

Technologies Supported: Wide variety of contactless credentials including HID Mobile Access® Mobile IDs via NFC and/or Bluetooth Smart.



1. select one option from each of the following sections

Reader Model (select one model)



900 - Model R10 - Designed for door applications requiring a small footprint card reader.



910 - Model R15 - Designed for door applications requiring a mullion style mounting.



920 - Model R40 - Designed for door applications requiring standard wall switch mounting.



921 - Model RK40 - Designed for door applications requiring standard wall switch mounting and keypad input.



95B - Décor Model - Designed for door applications requiring low profile EU square wall switch mounting.

125 kHz Credential Support (select one option)

- N** - No 125 kHz support
- P** - Support for HID Prox, AWID and EM4102 (32 bits)

13.56 MHz and Bluetooth Credential Support

- M** - Support for HID Mobile Access Mobiles IDs via NFC and Bluetooth Smart - reader equipped with Bluetooth Smart module. Also supports Seos, iCLASS SE, iCLASS SR, iCLASS, MIFARE Classic (SIO), MIFARE DESFire EV1 (SIO) and ISO 14443 UID.

Controller Communication (select one option)

- N** - Wiegand
- C** - Clock & Data
- P** - OSDP

Wiring Connection (select one option)

- N** - Pigtail (not available on 95B)
- T** - Terminal strip

Hardware Revision

- E** - Revision E

Color

- K** - Black
- G** - Grey (available on 95B only)
- W** - White (available on 95B only)

Keypad (select one option)

- M** - Mobile-Ready: Prepared to support HID Mobile Access, but lacks the personalized configuration to read an organization's specific Mobile IDs. This configuration can be ordered at any time but will require field activation after the organization has completed registration for HID Mobile Access.
- E** - Mobile-Enabled: Fully activated and personalized to support an organization's specific Mobile IDs. These readers can only be ordered after the organization has completed registration for either HID Elite or HID Mobile Access. If HID Elite reference (ICE) is given at time of order, only Seos credentials with HID Elite keys are supported. If Mobile Reference (MOB) is given at time of order, only Seos credentials with standard keys are supported.

Configuration setting (select one option)

Standard configuration: All iCLASS SE Readers - Standard Profile with Bluetooth Smart ship with the following features.

- Controller Communication = N - Wiegand, or P - OSDP
- LED normally red, LED flashes green and beeps on card read
- Keypad output is 4-bit (if keypad reader)

This configuration is represented by the following standard configuration setting extensions listed.

Communication	125 kHz Support	Keypad Reader	Extension
N - Wiegand	N - No	No	<input type="checkbox"/> A001
		Yes	<input type="checkbox"/> A002
	P - Yes	No	<input type="checkbox"/> A003
		Yes	<input type="checkbox"/> A004
P - OSDP	N - No	No	<input type="checkbox"/> A005
		Yes	<input type="checkbox"/> A006
	P - Yes	No	<input type="checkbox"/> A007
		Yes	<input type="checkbox"/> A008

ANY other option selected (including Clock & Data communication) requires a Non-Standard configuration EXTENSION. To determine configuration options, use the Select tab on the iCLASS SE Configuration Guide spreadsheet at the following link: www.hidglobal.com/documents/iclass-se-configuration-guide. Your HID Global Support or Sales representative can help you determine your final configuration.

2. Enter the numbers/letters from the previous selections into the following table

The resulting “Final Part Number” is used when ordering readers.

	Reader Model	125 kHz	13.56 MHz	Communication	Wiring	HW Rev	Color	Keypad	Config Setting
Example	920	N	M	N	T	E	K	M	A001
Final Part Number			M			E	K		

3. Place an order

To place an order for this product, authorized channel partners may submit a purchase order to HID Global Customer Service.

Contact information is available at: <http://www.hidglobal.com/customer-service>

Need credentials? Credentials supported by this reader model includes (depending on options chosen above):

- [Mobile IDs](#)
- [Seos](#)
- [iCLASS](#)
- [iCLASS SE](#)
- [MIFARE DESFire](#)
- [MIFARE Classic](#)

iCLASS SE Readers - Standard Profile







Application: Designed to ensure compatibility with legacy credentials and capability to support the future.

Technologies Supported: Wide variety of contactless credentials including HID Mobile Access Mobile IDs via NFC.



1. Select one from each of the following sections

Reader Model (select one model)

- | | |
|---|---|
|  <input type="checkbox"/> 900 - Model R10 - Designed for door applications requiring a small footprint card reader. |  <input type="checkbox"/> 921 - Model RK40 - Designed for door applications requiring standard wall switch mounting. Supports keypad input. |
|  <input type="checkbox"/> 910 - Model R15 - Designed for door applications requiring a mullion style mounting. |  <input type="checkbox"/> 940 - Model R90 - Designed for vehicle access applications requiring extended read range. |
|  <input type="checkbox"/> 920 - Model R40 - Designed for door applications requiring standard wall switch mounting. |  <input type="checkbox"/> 95A - Décor model - Designed for door applications requiring low profile EU square wall switch mounting. |

125 kHz Credential Support (select one option)

- N** - None
- P** - Supports HID Prox, AWID and EM4102 (32 bits). Not available on models 940 or 95A.
- L** - Supports Indala Prox, please make sure to provide the needed format at time of order. Not available on models 940 or 95A. Not available with OSDP communication and/or Custom Programming or Transit.

13.56 MHz Credential Support (select one option)

	Seos	iCLASS SE	iCLASS SR	iCLASS	MIFARE Classic (SIO)	MIFARE DESFire EV1 (SIO)	Mobile IDs via NFC	Mobile IDs via Bluetooth Smart	ISO14443 UID	MIFARE Classic (Custom data)	MIFARE DESFire EV1 (Custom data)	FeliCa IDm	CEPAS CAN or UID
<input type="checkbox"/> N - High security	•	•	•	–	•	•	•	–	–	–	–	–	–
<input type="checkbox"/> T - Maximum compatibility	•	•	•	•	•	•	•	–	•	–	–	–	–
<input type="checkbox"/> R - FeliCa and CEPAS ¹	•	•	•	•	•	•	•	–	•	–	–	•	•
<input type="checkbox"/> W - Custom programming ²	○	○	○	○	○	○	○	–	○	•	•	–	–

• Supported ○ Optionally supported – Not supported

¹ Not available on model 940.

² Consult your local HID sales representative for non-standard credential configuration requests.

Controller Communication (select one option)

- N** - Wiegand
- C** - Clock & Data
- P** - OSDP

Wiring Connection (select one option)

- N** - Pigtail (Not available on models 940 or 95A)
- T** - Terminal strip

Hardware Revision

- E** - Revision E

Color (select one option)

- K** - Black
- W** - White. Only available on 95A model.
- G** - Gray. Only available on 95A model.

Keypad (select one option)

- 0** - Standard v1 - Supports credentials with default HID keys, including iCLASS and iCLASS SR.
- 2** - Standard v2 - Supports credentials with default HID keys, not including iCLASS and iCLASS SR.
- E** - HID Elite - Supports credentials with HID Elite keys, including iCLASS and iCLASS SR, and/or Mobile IDs. Key reference (ICE or MOB) required at time of order.

Configuration Setting

- 0000** - Standard configuration:
 - 125 kHz Credential Support = N - None or P - Supports HID Prox, AWID and EM4102 (32 bits)
 - 13.56 MHz Credential Support = T - Maximum Compatibility
 - Controller Communication = N - Wiegand
 - Keypad = 0 - Standard v1 or E - HID Elite
 - LED normally red, LED flashes green and beeps on card read
 - Keypad output is 4-bit (if keypad reader)
- xxxx** - Non-Standard configuration: ANY other options selected above require a Non-Standard 4 digit extension. To order non-standard configuration options, use the Select tab on the iCLASS SE Configuration spreadsheet at the following link www.hidglobal.com/documents/iclass-se-configuration-guide. Your HID Global Support or Sales representative can help you determine your final configuration.

2. Enter the numbers/letters from the selections above into the following table

The resulting “Final Part Number” is used when ordering reader.

Reader Model		125 kHz	13.56 MHz	Communication	Wiring	HW Rev	Color	Keypad	Config Setting
Example	920	N	T	N	T	E	K	0	0000
Final Part Number						E			

3. Place an order

To place an order for this product, authorized channel partners may submit a purchase order to HID Global Customer Service.

Contact information is available at: www.hidglobal.com/customer-service

Need credentials? Credentials supported by this reader model include the following, depending on options chosen above:

- [Mobile IDs](#)
- [Seos](#)
- [iCLASS](#)
- [iCLASS SE](#)
- [MIFARE DESFire](#)
- [MIFARE Classic](#)

iCLASS SE Express Reader

Application: Designed for mullion mount installations, Wiegand and pigtail compatibility.

Technologies Supported: Seos, ISO14443 UID and HID Mobile Access Mobile IDs via NFC and/or Bluetooth Smart.



1. select one option from each of the following sections to construct part number

Reader Model (select one model)



900 - Model R10 - Designed for door applications requiring a small footprint card reader.

125 kHz Credential Support

N - No 125 kHz support

13.56 MHz and Bluetooth credential support (select one option)

- S** - Supports Seos cards, and Mobile IDs via NFC.
- B** - Supports Seos cards, and Mobile IDs via NFC and Bluetooth Smart.
- C** - Supports Seos cards, Mobile IDs via NFC and ISO14443 UID.
- D** - Supports Seos cards, Mobile IDs via NFC and Bluetooth Smart and ISO14443 UID.

Controller Communication

N - Wiegand

Wiring Connection

N - Pigtail

Hardware Revision

F - Revision F

Color

K - Black

Keypad (select one option)

- 2** - Standard and Mobile-Ready - supports Seos credentials with standard keys. Prepared to support HID Mobile Access, but lacks the personalized configuration to read an organization's specific Mobile IDs. This configuration can be ordered at any time but will require field activation after the organization has completed registration for HID Mobile Access.
- E** - HID Elite and Mobile-Enabled - supports Seos credentials and Mobile IDs. Fully activated and personalized to support an organization's specific Mobile IDs. These readers can only be ordered after the organization has completed registration for either HID Elite or HID Mobile Access. If HID Elite reference (ICE) is given at time of order, only Seos credentials with HID Elite keys are supported. If Mobile Reference (MOB) is given at time of order, only Seos credentials with standard keys are supported.

Configuration Settings

0000 - Standard configuration. All iCLASS SE Express Readers ship with the following standard configuration:

- LED normally red, LED flashes green and beeps on card read.

Non-standard configuration can be applied at time of installation using the HID Reader Manager mobile application available in the Apple App Store and Google play store.

xxxx - Non-Standard configuration: ANY other options selected above require a non-standard 4 digit extension. To order non-standard configuration options, use the Build a new reader option on the HID Global Product Configurator website located at <https://www.hidglobal.com/configure>. Your HID Global Support or Sales representative can help you determine your final configuration.

2. Enter the numbers/letters from the selections above into the table below

The resulting "Final Part Number" is used when ordering reader.

	Reader Model	125 kHz	13.56 MHz	Communication	Wiring	HW Rev	Color	Keypad	Config Setting
Example	900	N	S	N	N	F	K	2	0000
Final Part Number	900	N		N	N	F	K		0000



3. Place an order

To place an order for this product, authorized channel partners may submit a purchase order to HID Global Customer Service.

Contact information is available at: <http://www.hidglobal.com/customer-service>

Need credentials? Credentials supported by this reader model includes (depending on options chosen above):

- [Mobile IDs](#)
- [Seos](#)
- [Seos + Prox](#)

iCLASS SE Biometric Reader - Wiegand

Application: Designed for door applications requiring multi-factor authentication including biometric.

Technologies Supported: Seos 8kB and iCLASS 16kb-32kb credentials.

1. select one option from each section below

Reader Model (select one model)



- 928 - Model RKL40** - Designed for door applications requiring multi-factor authentication including biometric. Featuring an LCD display, biometric sensor and keypad.

125 kHz Credential Support

- N** - No 125 kHz support

13.56 MHz credential support (select one option)

- S** - Supports biometric template on Seos credentials
 F - Supports biometric template on Seos, iCLASS SR and iCLASS credentials

Controller Communication (select one option)

- N** - Wiegand
 C - Clock & Data

Controller Connection

- T** - Terminal strip

Hardware Revision

- E** - Revision E

Color

- K** - Black

iCLASS Support/Keypad (select one option)

- 0** - Standard v1 – Supports Seos, iCLASS SR and iCLASS credentials with default HID keys.
 2 - Standard v2 – Supports Seos credentials with default HID keys.
 E - HID Elite – Supports Seos, iCLASS SR and iCLASS credentials with HID Elite keys. Key reference (ICE or MOB) required at time of order.

Configuration Setting

Standard configuration iCLASS SE Biometric ship with the following features

- Controller Communication = N - Wiegand.
- 13.56 MHz Credential Support = S - Seos or F - Seos, iCLASS SR and iCLASS.
- LED normally red, LED flashes green and beeps on card read.
- Controller PIN verification with Keypad output 4-bit (local PIN verification is a non-standard configuration).

These configuration options are represented by the following standard configuration setting extensions listed.

Controller Communication	13.56 MHz Credential Support	Extension
N - Wiegand	S - Seos	<input type="checkbox"/> 00TG
	F - Seos, iCLASS SR and iCLASS	<input type="checkbox"/> 00TE

ANY other option selected (including Clock & Data communication) requires a Non-Standard configuration EXTENSION. To determine configuration options, use the Select tab on the iCLASS SE Configuration Guide spreadsheet at the following link: <https://www.hidglobal.com/documents/iclass-se-configuration-guide>. Your HID Global Support or Sales representative can help you determine your final configuration.



2. Enter the numbers/letters from the selections above into the table below

The resulting "Final Part Number" is used when ordering reader.

	Reader Model	125 kHz	13.56 MHz	Communication	Wiring	HW Rev	Color	Keypad	Config Setting
Example	928	N	F	N	T	E	K	0	XXXX
Final Part Number	928				T	E	K		

3. Place an order

To place an order for this product, authorized channel partners may submit a purchase order to HID Global Customer Service.

Contact information is available at: <http://www.hidglobal.com/customer-service>

Need credentials? Credentials supported by this reader model includes (depending on options chosen above):

- [Mobile IDs](#)
- [Seos](#)
- [iCLASS](#)
- [iCLASS SE](#)
- [MIFARE DESFire](#)
- [MIFARE Classic](#)

iCLASS SE Readers - Magnetic Stripe

Application: Designed to ensure compatibility with legacy credentials and capability to support the future.

Technologies Supported: Magnetic stripe cards and a wide variety of contactless credentials including HID Mobile Access Mobile IDs via NFC.



1. select one option from each of the following sections

Reader Model (select one model)



922 - Model RM40 - Designed for door applications requiring standard wall switch mounting.



925 - Model RMK40 - Designed for door applications requiring standard wall switch mounting. Supports keypad input.

125 kHz Credential Support (select one option)

- N** - No 125 kHz support
- P** - Support for HID Prox, AWID and EM4102 (32 bit)

13.56 MHz Credential Support (select one option)

	Seos	iCLASS SE	iCLASS SR	iCLASS	MIFARE Classic (SIO)	MIFARE DESFire EV1 (SIO)	Mobile IDs via NFC	Mobile IDs via Bluetooth Smart	ISO14443 UID	MIFARE Classic (Custom data)	MIFARE DESFire EV1 (Custom data)
<input type="checkbox"/> T - Maximum compatibility	•	•	•	•	•	•	•	-	•	-	-
<input type="checkbox"/> N - High security Wiegand	•	•	•	-	•	•	•	-	-	-	-
<input type="checkbox"/> W - Custom programming*	o	o	o	o	o	o	o	-	o	•	•

• Supported o Optionally supported - Not supported

*Consult your local HID sales representative for non-standard credential configuration requests.

Controller Communication (select one option)

- N** - Wiegand
- C** - Clock & Data
- P** - OSDP

Wiring Connection (select one option)

- N** - Pigtail
- T** - Terminal strip

Hardware Revision

- E** - Revision E

Color

- K** - Black

iCLASS Support/Keypad (select one option)

- 0** - Standard v1 – Reads credentials with default HID keys including standard iCLASS and/or iCLASS SR.
- 2** - Standard v2 – Reads credentials with default HID keys not including standard iCLASS and/or iCLASS SR.
- E** - HID Elite – Reads credentials with HID Elite keys, including iCLASS and iCLASS SR, and/or Mobile IDs. Key reference (ICE or MOB) required at time of order.

Configuration Settings

To determine configuration options, use the **Select** tab on the iCLASS SE Configuration Guide spreadsheet at the following link: <https://www.hidglobal.com/documents/iclass-se-configuration-guide>. Your HID Global Support or Sales representative can help you determine your final configuration.

2. Enter the numbers/letters from the selections above into the table below

The resulting “Final Part Number” is used when ordering reader.

Reader Model		125 kHz	13.56 MHz	Communication	Wiring	HW Rev	Color	Keypad	Config Setting
Example	922	N	N	N	T	E	K	2	XXXX
Final Part Number						E	K		

3. Place an order

To place an order for this product, authorized channel partners may submit a purchase order to HID Global Customer Service.

Contact information is available at: www.hidglobal.com/customer-service.

Need credentials? Credentials supported by this reader model include (depending on options chosen above):

- [Mobile IDs](#)
- [Seos](#)
- [iCLASS](#)
- [iCLASS SE](#)
- [HID Prox](#)
- [MIFARE DESFire](#)
- [MIFARE Classic](#)

pivCLASS Readers - FIPS 201 Strong Authentication

Application: Designed for applications that leverage the pivCLASS® Authentication Module (PAM) to validate FIPS 201 credential certificates for the highest level of security.

Technologies Supported: FIPS 201 credentials such as PIV, CIV, TWIC, CAC, and FRAC, and a wide variety of other contactless credentials.



1. select one option from each section below

Reader Model (select one model)



- 900 - Model R10** - Designed for door applications requiring a small footprint card reader.



- 923 - Model RKCL40** - Designed for door applications requiring standard wall switch mounting. Featuring a contact slot, LCD display, and **keypad**.



- 920 - Model R40** - Designed for door applications requiring standard wall switch mounting.



- 924 - Model RKCLB40** - Designed for door applications requiring standard wall switch mounting. Featuring a contact slot, LCD display, biometric sensor, and **keypad**.



- 921 - Model RK40** - Designed for door applications requiring standard wall switch mounting. Supports keypad input.

125 kHz Credential Support (select one option)

- N** - No 125 kHz support
- P** - Support for HID Prox, AWID and EM4102 (32 bit) (not available on model RKCLB40)

13.56 MHz credential support (select one option)

- H** - Contactless. Supports PKI-Based FIPS 201 Credentials including PIV, PIV-I, CIV, CAC, TWIC and FRAC. This option is only available for models R10, R40 and RK40.
- P** - Contactless + Contact. Supports PKI-Based FIPS 201 Credentials including PIV, PIV-I, CIV, CAC, TWIC and FRAC. FIPS 201 type cards can be read using either the contact or contactless card interface (RKCL40). This option is only available for models RKCL40 and RKCLB40.

Controller Communication (select one option)

- R** - RS485 FDX. Full duplex is required when connecting a pivCLASS reader to a PAM.
- P** - RS485 HDX OSDP. Half duplex connection requires a connection with an OSDP-compliant strong authentication controller infrastructure. Only available with RKCL40.

Controller Connection (select one option)

- N** - Pigtail
- T** - Terminal strip

Hardware Revision

- E** - Revision E

Color

- K** - Black

Keypad (select one option)

- 0** - Standard v1 - Reads credentials with default HID keys including standard iCLASS and/or iCLASS SR.
- E** - HID Elite - Reads credentials with HID Elite keys, including iCLASS and iCLASS SR, and/or Mobile IDs. Key reference (ICE or MOB) required at time of order.



Configuration Setting (select one option)

Configuration setting extension for these reader models depends on the model and 125 kHz support chosen above, select from list below:

Reader Model	125 kHz Support	Extension
R10/R40	N - No	<input type="checkbox"/> 032Y
	P - Yes	<input type="checkbox"/> 0007
RK40	N - No	<input type="checkbox"/> 033A
	P - Yes	<input type="checkbox"/> 033B
RKCL40	N - No	<input type="checkbox"/> 032V
	P - Yes	<input type="checkbox"/> 0008
RKCLB40	N - No	<input type="checkbox"/> 0504

2. Enter the numbers/letters from the selections above into the table below

The resulting "Final Part Number" is used when ordering reader.

Reader Model		125 kHz	13.56 MHz	Communication	Wiring	HW Rev	Color	Keypad	Config Setting
Example	900	N	H	R	T	E	K	0	032Y
Final Part Number				R		E	K		

3. Place an order

To place an order for this product, authorized channel partners may submit a purchase order to HID Global Customer Service.

Contact information is available at: www.hidglobal.com/customer-service

Need credentials? Credentials supported by this reader model includes (depending on options chosen above):

- [Seos](#)
- [iCLASS SE](#)
- [iCLASS](#)
- [HID Prox](#)
- [MIFARE DESFire](#)
- [MIFARE Classic](#)

pivCLASS Readers - Wiegand or OSDP

Application: Designed to support FIPS 201 credentials and communicate to traditional intelligent controller using Wiegand or OSDP protocol.

Technologies Supported: FIPS 201 credentials such as PIV, CIV, TWIC, CAC, and FRAC and a wide variety of contactless credentials.

1. select one option from each section below

Reader Model (select one model)



- 900 - Model R10** - Designed for door applications requiring a small footprint card reader.



- 921 - Model RK40** - Designed for door applications requiring standard wall switch mounting.



- 920 - Model R40** - Designed for door applications requiring standard wall switch mounting.



- 923 - RKCL40** - Combination, contact plus contactless reader with keypad and LCD.

125 kHz Credential Support (select one option)

- N** - No 125 kHz support
 P - Support for HID Prox, AWID and EM4102 (32 bit)

13.56 MHz credential support (select one option)

- H** - Contactless. Supports PKI-Based FIPS 201 Credentials including PIV, PIV-I, CIV, CAC, TWIC and FRAC. This option is only available for models R10, R40 and RK40.
 P - Contactless + Contact. Supports PKI-Based FIPS 201 Credentials including PIV, PIV-I, CIV, CAC, TWIC and FRAC. FIPS 201 type cards can be read using either the contact or contactless card interface. This option is only available for model RKCL40.

Controller Communication (select one option)

- R** - Wiegand; Configurable to support RS-485 full duplex for communication with pivCLASS Authentication Module (PAM).
 P - Wiegand or OSDP via RS-485 half duplex; selectable through configuration. Not available for model with RKCL40.

Controller Connection (select one option)

- N** - Pigtail
 T - Terminal strip

Hardware Revision

- E** - Revision E

Color

- K** - Black

iCLASS Support/Keypad (select one option)

- 0** - Standard v1 - Reads credentials with default HID keys including standard iCLASS and/or iCLASS SR.
 E - HID Elite - Reads credentials with HID Elite keys, including iCLASS and iCLASS SR, and/or Mobile IDs. Key reference (ICE or MOB) required at time of order.

Configuration Setting

Obtaining individual pivCLASS reader configuration settings requires the use of the online [Configuration Guide](#).

2. Enter the numbers/letters from the selections above into the table below

The resulting "Final Part Number" is used when ordering reader.

Reader Model	125 kHz	13.56 MHz	Communication	Wiring	HW Rev	Color	Keypad	Config Setting	
Example	900	N	H	R	T	E	K	0	XXXX
Final Part Number			R		E	K			



3. Place an order

To place an order for this product, authorized channel partners may submit a purchase order to HID Global Customer Service.

Contact information is available at: <http://www.hidglobal.com/customer-service>

Need credentials? This reader could support (depending on options chosen above) the following credentials:

- [Seos](#)
- [iCLASS](#)
- [iCLASS SE](#)
- [HID Prox](#)
- [MIFARE DESFire](#)
- [MIFARE Classic](#)

iCLASS SE U90 - UHF Long Range Reader

Application: Designed for vehicle access control installations which require long range authentication and high throughput.

Technologies Supported: Ultra High Frequency (UHF) EPC GEN 2.

1. select one option from each section below to construct part number

Reader Model (select one model)



RDRSEU90 - Model U90® – Contactless Smart Card Long Range Reader: Surface or Pole Mount.

Antenna Code (select one option, see table below)

8

9

Country	Operating Frequency	Antenna Code	Country	Operating Frequency	Antenna Code	Country	Operating Frequency	Antenna Code
Argentina	902 - 928 MHz	9	Estonia	865 - 868 MHz	8	Mexico	902 - 928 MHz	9
Austria	865 - 868 MHz	8	Finland	865 - 868 MHz	8	Netherlands	865 - 868 MHz	8
Australia	915 - 928 MHz	9	France	865 - 868 MHz	8	New Zealand	921.5 - 928 MHz	9
Belgium	865 - 868 MHz	8	Germany	865 - 868 MHz	8	Poland	865 - 868 MHz	8
Brazil	902 - 928 MHz	9	Greece	865 - 868 MHz	8	Portugal	865 - 868 MHz	8
Bulgaria	865 - 868 MHz	8	Hungary	865 - 868 MHz	8	Romania	865 - 868 MHz	8
Canada	902 - 928 MHz	9	India	865 - 867 MHz	8	Slovakia	865 - 868 MHz	8
China	921 - 924 MHz	9	Ireland	865 - 868 MHz	8	Slovenia	865 - 868 MHz	8
Columbia	902 - 928 MHz	9	Italy	865 - 868 MHz	8	Spain	865 - 868 MHz	8
Croatia	865 - 868 MHz	8	Latvia	865 - 868 MHz	8	Sweden	865 - 868 MHz	8
Cyprus	865 - 868 MHz	8	Lithuania	865 - 868 MHz	8	United Arab Emirates	865 - 868 MHz	8
Czech Republic	865 - 868 MHz	8	Luxembourg	865 - 868 MHz	8	United Kingdom	865 - 868 MHz	8
Denmark	865 - 868 MHz	8	Malta	865 - 868 MHz	8	United States	902 - 928 MHz	9

Color

K - Black

Keypad (select one option)

Note: Keypad is factory-configured only and cannot be configured in the field, via web interface or configuration cards.

0 - Standard Keypad

E - HID Elite keypad – reads only HID Elite credentials with corresponding keypad. Line item on PO requires ICE reference number.

2. Enter the numbers/letters from the selections above into the table below

The resulting "Final Part Number" is used when ordering reader.

Product Class	Product Sub Class	Base Reader	Antenna Code	Color	Keypad	Configuration Setting	
Example	RDR	SE	U90	8	K	0	0000
Final Part Number	RDR	SE	U90	K			0000

3. Place an order

To place an order for this product, authorized channel partners may submit a purchase order to HID Global Customer Service.

Contact information is available at: <http://www.hidglobal.com/customer-service>

Need credentials? This reader supports the following credentials:

- [UHF cards](#)
- [UHF + iCLASS cards](#)

iCLASS SE Reader Accessories

Configuration Cards

Use these cards for customer reader configuration. Readers may be reconfigured to a target configuration by applying the correct target configuration. Use the following link to access the iCLASS SE Configuration Worksheet <https://www.hidglobal.com/documents/iclass-se-configuration-guide> to determine the exact configuration required. Apply changes to the reader security using programming cards. Contact HID Technical Support (www.hidglobal.com/support) to ensure selecting the proper settings.

Note: Elite downgrade cards are no longer available, if required, please contact your local technical support or sales engineering representative.

Configuration Card Part Numbers for iCLASS Rev E readers(with firmware versions lower than R8.10.2.7)*			
*For iCLASS SE readers already in the field that HAVE NOT been upgraded to R8.10.2.7 or higher using Reader Manager			
Description	Part Number		
	Base Part No.	HID Elite (E) or Standard Security (0 or 2)	Configuration Settings ¹
Reader Configuration Cards			-XXXX = Specific configuration
Reconfigure reader to factory configuration settings (does not reconfigure reader admin or credential keys)	SEC9X-CRD-	E = HID Elite Key ² 0 = Standard-1 key or standard-2 key ²	-0000 = Factory configuration (Rx models) -0001 = Factory configuration (RPx models) -0002 = Factory configuration (RKx models) -0003 = Factory configuration (RPKx models)
HID Elite Upgrade Cards³ Setup iCLASS SE or multiCLASS[®] SE readers for HID Elite credential keys or Reader admin keys	SEC9X-CRD-	E = HID Elite Key ⁴	-P000 = HID Elite reader admin keys
		E = HID Elite Key ²	-P001 = HID Elite reader credential keys

Configuration Card Part Numbers for iCLASS Rev E readers(with firmware versions R8.10.2.7 or higher)*			
* For iCLASS SE readers in the field that HAVE been upgraded to R8.10.2.7 higher using Reader Manager			
* Add a "-1" suffix to existing configuration card part numbers for compatibility			
Description	Part Number		
	Base Part No.	HID Elite (E) or Standard Security (0 or 2)	Configuration Settings ¹
Reader Configuration Cards			-XXXX = Specific configuration
Reconfigure reader to factory configuration settings (does not reconfigure reader admin or credential keys)	SEC9X-CRD-	E = HID Elite Key ² 0 = Standard-1 key or standard-2 key ²	-0000-1 = Factory configuration (Rx models) -0001-1 = Factory configuration (RPx models) -0002-1 = Factory configuration (RKx models) -0003-1 = Factory configuration (RPKx models)
HID Elite Upgrade Cards³ Setup iCLASS SE or multiCLASS[®] SE readers for HID Elite credential keys or Reader admin keys	SEC9X-CRD-	E = HID Elite Key ⁴	-P000-1 = HID Elite reader admin keys
		E = HID Elite Key ²	-P001-1 = HID Elite reader credential keys

Example:

Existing configuration card P/N is **SEC9X-CRD-0-0000**, if the reader is upgraded to R8.10.2.7 or higher order compatible configuration card P/N = **SEC9X-CRD-0-0000-1**

¹ Configuration Settings

All standard readers ship with the following features - 13.56 MHz interpreter "T" enabled, Wiegand "N" enabled, and Standard-1 "0" security keys enabled. ANY other option selected requires a specific configuration EXTENSION. To order non-standard configuration options, use the following link to access the iCLASS SE Configuration Worksheet <https://www.hidglobal.com/documents/iclass-se-configuration-guide>. Your HID Global Support or Sales representative can help you determine your final configuration.

Standard configuration includes: LED normally Red + Reader beeps / flashes LED green on card read + Intelligent Power Management = Off + Keypad Output is 4-bit (if keypad reader)

Note: Reader configuration cards change settings in an additive fashion. Configuration card settings only overwrite old settings for the options selected. Reader settings that have not been selected for the configuration retain their original values. To reset reader settings to factory defaults, use a factory default configuration card first, then apply the new configuration with the provided reader configuration card.

² Keys

Specify HID Elite "E" or Standard-1/Standard-2 "0" based upon keys ALREADY LOADED in the reader that needs to be configured.

³ HID Elite Upgrade Cards

Reader admin keys and reader credential keys must both be changed to upgrade to Elite. A separate card is required for reader admin keys and reader credential keys. A Reader Configuration Card with specific configuration extension SEC9X-0/E-XXXX or SEC9X-0/E-XXX(0, 1, 2, 3) is also required to modify configuration options other than Elite keys, for example modification of 125 kHz or 13.56 MHz interpreters.

⁴ Keys

Specify HID Elite "E" based upon HID Elite keys TO BE LOADED in the reader that needs to be configured.

Accessories

The following provides accessories that can be ordered separately for your iCLASS SE and multiCLASS SE readers.

Part Number	Description
Mounting Plates, Spacers, Screws and Accessory Kits	
MDP-00354	R10 / RP10 (or equivalent sized model) Mini Mullion Reader Mounting Plate, Black
6309-103-01	R15 / RP15 (or equivalent sized model) Mullion Reader Mounting Plate, Black
6403-109-01	R40 / RP40 (or equivalent sized model) Wall Switch Reader Mounting Plate, Black
6094-101-01	RK40 / RPK40 (or equivalent sized model) Wall Switch Keypad Reader Mounting Plate, Black
6132AKB	R10 / RP10 (or equivalent sized model) Reader Spacer, 12.7mm (0.5 in), Black
6132AKC	R15 / RP15 (or equivalent sized model) Reader Spacer, 12.7mm (0.5 in), Black
6132AKT	R40 / RP40 (or equivalent sized model) Reader Spacer, 12.7mm (0.5 in), Black
6132AKU	RK40 / RPK40 (or equivalent sized model) Reader Spacer, 12.7mm (0.5 in), Black
6132AKE	R40 / RP40 (or equivalent sized model) Reader Spacer, 25.4mm (1.0 in), Black
6132AK	RK40 / RPK40 (or equivalent sized model) Reader Spacer, 25.4mm (1.0 in), Black
6132AKR	RM40 / RMK40 (or equivalent sized model) Reader Spacer, Angled, Black
6132AKP	RM40 / RMK40 (or equivalent sized model) Reader Spacer, 25.4mm (1.0 in), Black
6715-305-01	R95A Reader, Cover Assembly, Décor, Euro, White
6715-305-04	R95A Reader, Cover Assembly, Décor, Euro, Black
MDP-00038	R95A Reader, Cover Assembly, Décor, Euro, Grey
400-2D71-06	High Security Screw, Spanner
6706-303-03	Pigtail Accessory Kit (includes terminal blocks, screws, and installation guide)
6706-303-04	Terminal Reader Accessory Kit (includes terminal blocks, screws, and installation guide)
6132AKB-M	R10 / RP10 BLE Reader Spacer, 12.7mm (0.5 in), Metallic Insert, Black
6132AKC-M	R15 / RP15 BLE Reader Spacer, 12.7mm (0.5 in), Metallic Insert, Black
6132AKT-M	R40 / RP40 BLE Reader Spacer, 12.7mm (0.5 in), Metallic Insert, Black
6132AKE-M	R40 / RP40 BLE Reader Spacer, 25.4mm (1.0 in), Metallic Insert, Black
6132AKU-M	RK40 / RPK40 BLE Reader Spacer, 12.7mm (0.5 in), Metallic Insert, Black
MME-00118	R10 / RP10 BLE Reader Metallic Insert with Adhesive (order in conjunction with spacer or mounting plate)
MME-00119	R15 / RP15 BLE Reader Metallic Insert with Adhesive (order in conjunction with spacer or mounting plate)
MME-00121	R40 / RP40 BLE Reader Metallic Insert with Adhesive (order in conjunction with spacer or mounting plate)
MME-00122	RK40 / RPK40 BLE Reader Metallic Insert with Adhesive (order in conjunction with spacer or mounting plate)

IP65 Upgrade Kit

For upgrading iCLASS SE Readers to IP65 Ingress Protection in the Field IP65 Kit Description (10) Pieces Per Kit	Part Number
IP65 Gasket Kit, (10) pcs per kit. For use with model R10	IP65GSKT-R10
IP65 Gasket Kit, (10) pcs per kit. For use with model R15	IP65GSKT-R15
IP65 Gasket Kit, (10) pcs per kit. For use with model R40	IP65GSKT-R40
IP65 Gasket Kit, (10) pcs per kit. For use with model RK40	IP65GSKT-RK40

UHF Credential Card Holder

For correct placement and attachment of UHF Credentials to inside of car windshield	Part Number
Windshield Mount, suction cup, adhesive for ID 1 style credential, Blue (Qty 10)	WSHLDMT-BLU
Windshield Mount, suction cup, adhesive for ID 1 style credential, Clear (Qty 10)	WSHLDMT-CLR
Windshield Mount, suction cup, adhesive for ID 1 style credential, White (Qty 10)	WSHLDMT-WHT
Windshield Mount, suction cup, adhesive for ID 1 style credential, Blue (Qty 250)	WSHLDMT-BLU-BULK
Windshield Mount, suction cup, adhesive for ID 1 style credential, Clear (Qty 250)	WSHLDMT-CLR-BULK
Windshield Mount, suction cup, adhesive for ID 1 style credential, White (Qty 250)	WSHLDMT-WHT-BULK
Suction Cups for WSHLDMT - Kit contains (200) cups	WSHLDMT-CUPS
Double sided tape for WSHLDMT - Kit contains (200) pieces	WSHLDMT-TAPE

iCLASS SE and multiCLASS SE Bluetooth and OSDP Upgrade Kit

For upgrading select iCLASS SE and multiCLASS SE Reader models to support Bluetooth and/or OSDP For detailed reader compatibility requirements, see https://www.hidglobal.com/reader-manager-system-requirements	Part Number
Reader Module and Metallic Backplate Sticker to upgrade 1 Reader. For use with iCLASS SE Reader model R10 or RP10	BLEOSDP-UPG-A-900
Reader Module and Metallic Backplate Sticker to upgrade 1 Reader. For use with iCLASS SE Reader model R15 or RP15	BLEOSDP-UPG-A-910
Reader Module and Metallic Backplate Sticker to upgrade 1 Reader. For use with iCLASS SE Reader model R40 or RP40	BLEOSDP-UPG-A-920
Reader Module and Metallic Backplate Sticker to upgrade 1 Reader. For use with iCLASS SE Reader model RK40 or RPK40	BLEOSDP-UPG-A-921

iCLASS Reader Accessories

Part Number	Description
iCLASS Reader Accessories	
6303-104-01	Mini-Mullion Reader Mounting Plate for iCLASS SE R10, RP10 and iCLASS RW100
6309-103-01	Mullion Reader Mounting Plate for iCLASS SE R15 and RP15
6402-103-01	EU/Asian Reader Mounting Plate for iCLASS RW300
6403-109-01	Wall Switch Reader Mounting Plate for iCLASS SE R40, RP40 and iCLASS RW400
6094-101-01	Wall Switch Keypad Reader Mounting Plate for iCLASS SE RK40, RPK40 and iCLASS RWK400
6132AKB	Mini-Mullion Reader Spacer for iCLASS SE R10, RP10 and iCLASS RW100, Black
6132AKC	Mullion Reader Spacer for iCLASS SE R15, RP15, Black
6132AKD	EU/Asian Reader Spacer for iCLASS RW300, Black
6132AKE	iCLASS Wall Switch Reader Spacer, Black (works with R40, RP40, RW400)
6132AK	iCLASS Wall Switch Keypad Reader Spacer, Black (works with RK40, RPK40, RWK400)
400-2D71-06	iCLASS reader security screw (Qty 1)

HID Proximity Readers

Prox Premier Reader – 900PX / 920PX

Note: Check with your HID representative on availability in your region.

Card Reader Description	Base Part No.
Prox™ Premier Reader with Wiegand output – Mini Mullion With Wiegand output – Wall Switch	900PXNNEK20000 920PXNNEK20000

Notes:

Default options and configurations are as follows (factory programmed):

- Bezel color – Black
- Wiring connection – Pigtail (18 in / 46 cm)
- HID Prox, AWID, EM4102
- Secure Identity Object™ on Seos®
- Support for Mobile credentials via NFC (HID Mobile Access powered by Seos)

To order, specify the following:

Card Reader Description	Base Part No.

ProxPoint Plus Proximity Reader - 6005 / 6008

Card Reader Description	Base Part No.	Current Rev. No.*	Color Options	Hardware Options	Configuration Setting Options ¹	Custom ²
ProxPoint™ Plus Proximity Reader with Wiegand output	6005	B	G = Classic Charcoal Gray B = Classic Beige W = Classic White	B = Pigtail (18 inches/45.7 cm)	00 04 01 05	XXXX Y
with Clock and Data output	6008	B	1 = Designer Black 2 = Designer Charcoal Gray 4 = Designer Wave Blue 5 = Designer White	L = Long Pigtail (9 feet/3 meters) ³	02 06 03 07	

* Revision numbers and availability are subject to change without notice.

Notes:

¹ Configuration Setting Options are as follows (factory programmed):

- | | |
|---|---|
| 00 = Beep on, LED normally red, reader flashes green on tag read | 04 = Beep on, LED normally red, host must flash green |
| 01 = Beep off, LED normally red, reader flashes green on tag read | 05 = Beep off, LED normally red, host must flash green |
| 02 = Beep on, LED normally off, reader flashes green on tag read | 06 = Beep on, LED normally off, host must flash red and/or green |
| 03 = Beep off, LED normally off, reader flashes green on tag read | 07 = Beep off, LED normally off, host must flash red and/or green |

² Consult Factory

³ An optional 9 foot pigtail is available through our HID European office and can also be available in the Americas and Asia Pacific regions via special order of 2,500 unit minimum order quantity. Call the HID factory for pricing and lead-times.

To order, specify the following:

Card Reader Description	Base Part No.	Current Rev. No.*	Color Options	Hardware Options	Configuration Setting Options ¹	Custom

MiniProx Proximity Reader - 5365 / 5368

Card Reader Description	Base Part No.	Current Rev. No.*	Color Options	Hardware Options	Configuration Setting Options ¹	Custom ²
MiniProx® Plus Proximity Reader with Wiegand output	5365	E	G = Classic Charcoal Gray B = Classic Beige	P = Pigtail (18 inches/45.7 cm)	00 04	XXXX Y
with Clock and Data output	5368	E	W = Classic White K = Classic Black 1 = Designer Black 2 = Designer Charcoal Gray 4 = Designer Wave Blue 5 = Designer White	T = Terminal Strip H = Hazardous back box ³	01 05 02 06 03 07	

* Revision numbers and availability are subject to change without notice.

Notes:

¹ Configuration Setting Options are as follows (factory programmed):

- | | |
|---|---|
| 00 = Beep on, LED normally red, reader flashes green on tag read | 04 = Beep on, LED normally red, host must flash green |
| 01 = Beep off, LED normally red, reader flashes green on tag read | 05 = Beep off, LED normally red, host must flash green |
| 02 = Beep on, LED normally off, reader flashes green on tag read | 06 = Beep on, LED normally off, host must flash red and/or green |
| 03 = Beep off, LED normally off, reader flashes green on tag read | 07 = Beep off, LED normally off, host must flash red and/or green |

² Consult Factory

³ The hazardous back box option MiniProx is available in gray Terminal Strip only.

To order, specify the following:

Card Reader Description	Base Part No.	Current Rev. No.*	Color Options	Hardware Options	Configuration Setting Options ¹	Custom ²

ProxPro Family Proximity Reader - 5455 / 5458 / 5355 / 5352 / 5358

ProxPro Family Card Reader Description	Base Part No.	Current Rev. No.*	Color Options	Hardware Options	Configuration Setting Options ¹	Custom ²
ProxPro® II Proximity Reader with Wiegand output with Clock & Data Output	5455 5458	B	G = Charcoal Gray B = Beige W = White K = Black	N = No Keypad, Pigtail (18 inches/45.7 cm)	00 04 01 05 02 06 03 07	XXXX Y
ProxPro Proximity Reader ^{5,6} with Wiegand output with Clock & Data Output	5355 5358	A	G = Charcoal Gray B = Beige	N = No Keypad, Terminal Strip K = Keypad ³ , Terminal Strip S = Keypad ⁴ , Terminal Strip	00 09 10 11 14 19 20 21 23	XXXX Y
ProxPro Proximity Reader with Serial output ⁷	5352				00 09 10 11 14 19 20 21 23	

* Revision numbers and availability are subject to change without notice.

¹ ProxPro II Configuration Setting Options are as follows (factory programmed):

00 = Beep on, LED normally red, reader flashes green on tag read	04 = Beep on, LED normally red, host must flash green
01 = Beep off, LED normally red, reader flashes green on tag read	05 = Beep off, LED normally red, host must flash green
02 = Beep on, LED normally off, reader flashes green on tag read	06 = Beep on, LED normally off, host must flash red and/or green
03 = Beep off, LED normally off, reader flashes green on tag read	07 = Beep off, LED normally off, host must flash red and/or green

² Consult Factory

³ ProxPro Reader with Keypad (Hardware Option K Version): data is outputted over shared Wiegand cable. Reader processes keystrokes.

⁴ ProxPro Reader with Keypad (Hardware Option S Version): (3 x 4 Matrix) requires additional 7 conductor keypad cable. Control panel processes keystrokes

⁵ ProxPro Configuration Setting options are as follows (factory programmed):

00 = Buffer one key, no parity, 4 bit message	14 = Buffer one to five keys (Standard 26 bit output)
09 = Buffer one key, add compliment, 8 bit message (Dorado)	19 = Buffer four keys and add parity
10 = Buffer six keys and add parity	20 = Single Key buffering
11 = Buffer one key and add parity	21 = Supervision Mode
	23 = Buffer one to 11 keys

⁶ ProxPro reader Configuration Settings are selected by the customer via dip switch settings. 00 = LED normally red, reader flashes green on tag reads.

⁷ ProxPro Serial output reads cards with up to 37-bit formats, and outputs RS232 and RS422.

Optional Glass Mount Kit for ProxPro and ProxPro II Readers = 5455AGM00.

To order, specify the following:

Card Reader Description	Base Part No.	Current Rev. No.*	Color Options	Hardware Options	Configuration Setting Options ¹	Custom

ThinLine II Proximity Reader - 5395 / 5398

Card Reader Description	Base Part No.	Current Rev. No.*	Color Options	Hardware Options	Configuration Setting Options ¹	Custom ²
ThinLine II Proximity Reader with Wiegand output with Clock and Data output	5395 5398	C	G = Classic Charcoal Gray B = Classic Beige W = Classic White K = Classic Black 1 = Designer Black 2 = Designer Charcoal Gray 4 = Designer Wave Blue 5 = Designer White	1 = Pigtail (18 inches/45.7 cm)	00 04 01 05 02 06 03 07	XXXX Y

* Revision numbers and availability are subject to change without notice.

Notes:

¹ Configuration Setting Options are as follows (factory programmed):

00 = Beep on, LED normally red, reader flashes green on tag read

01 = Beep off, LED normally red, reader flashes green on tag read

02 = Beep on, LED normally off, reader flashes green on tag read

03 = Beep off, LED normally off, reader flashes green on tag read

04 = Beep on, LED normally red, host must flash green

05 = Beep off, LED normally red, host must flash green

06 = Beep on, LED normally off, host must flash red and/or green

07 = Beep off, LED normally off, host must flash red and/or green

² Consult Factory

To order, specify the following:

Card Reader Description	Base Part No.	Current Rev. No.*	Color Options	Hardware Options	Configuration Setting Options ¹	Custom ²



MaxiProx Proximity Reader - 5375

Card Reader Description	Base Part No.	Current Rev. No.*	Color Options	Hardware Options	Configuration Setting Options ¹	Custom ²
MaxiProx® Proximity Reader	5375	A	G = Charcoal Gray	N = None	00	XXXX Y

* Revision numbers and availability are subject to change without notice.

Notes:

¹ Configuration Setting 00 = LED normally red, reader flashes green on tag reads.

The MaxiProx reader configuration settings are selected by the customer via internal dip switch settings.

² Consult Factory

To order, specify the following:

Card Reader Description	Base Part No.	Current Rev. No.*	Color Options	Hardware Options	Configuration Setting Options ¹	Custom ²



EntryProx Proximity Reader - 4045

Card Reader Description	Base Part No.	Current Rev. No.*	Color Options	Hardware Options	Configuration Setting Options ¹	Custom ²
EntryProx™ Proximity Reader Stand-Alone Access Control Unit	4045	C	G = Charcoal Gray	N = None	U0	XXXX Y

* Revision numbers and availability are subject to change without notice.

Notes:

¹ Configuration Setting U0 = LED normally red, reader flashes green on tag reads.

² Consult Factory

To order, specify the following:

Card Reader Description	Base Part No.	Current Rev. No.*	Color Options	Hardware Options	Configuration Setting Options ¹	Custom ²



HID Proximity Reader Accessories

Part Number	Description
ProxPro Family	
5455AGM00	Glass Mount Kit, ProxPro and ProxPro II Readers
5350-113-01	Bezel, ProxPro Reader with Keypad (Rev. A) - Charcoal Gray
5350-113-02	Bezel, ProxPro Reader (Rev. A) - Charcoal Gray
5350-113-03	Bezel, ProxPro Reader with Keypad (Rev. A) - Beige
5350-113-04	Bezel, ProxPro Reader (Rev. A) - Beige
5355A-302-01	Cover, ProxPro w/Keypad Reader (Rev. A) - Charcoal Gray
5355A-302-02	Cover, ProxPro Reader (Rev. A) - Charcoal Gray
5355A-302-03	Cover, ProxPro w/Keypad Reader (Rev. A) - Beige
5355A-302-04	Cover, ProxPro Reader (Rev. A) - Beige
5350-101-01	Base, ProxPro Reader (Rev. A) - Charcoal Gray
5350-101-02	Base, ProxPro Reader (Rev. A) - Beige
5355A-306-01	ProxPro Keypad assembly upgrade, K Version, (Rev. A) - Gray Cover only
5355A-306-02	ProxPro Keypad assembly upgrade, K Version, (Rev. A) - Beige Cover only
5355A-306-03	ProxPro Keypad assembly upgrade, S Version, (Rev. A) - Gray Cover only
5355A-306-04	ProxPro Keypad assembly upgrade, S Version, (Rev. A) - Beige Cover only
5355A-306-05	ProxPro Keypad assembly upgrade, K Version, (Rev. A) - Gray Cover and Bezel
5355A-306-06	ProxPro Keypad assembly upgrade, K Version, (Rev. A) - Beige Cover and Bezel
5355A-306-07	ProxPro Keypad assembly upgrade, S Version, (Rev. A) - Gray Cover and Bezel
5355A-306-08	ProxPro Keypad assembly upgrade, S Version, (Rev. A) - Beige Cover and Bezel
5455-311-01	Cover, ProxPro II Reader (Rev. B) - Charcoal Gray (No Bezel Required)
5455-311-02	Cover, ProxPro II Reader (Rev. B) - Beige (No Bezel Required)
5455-311-03	Cover, ProxPro II Reader (Rev. B) - Black (No Bezel Required)
5455-311-04	Cover, ProxPro II Reader (Rev. B) - White (No Bezel Required)
30-0003-01	Rubber Keypad Cover, ProxPro Reader (Rev. A)
137-0005-11	Connector Feed Back Nut and Washer, ProxPro Reader (Rev. A)
MiniProx	
5365-371-01	Classic cover, MiniProx Reader (Rev. E) - Charcoal Gray
5365-371-02	Classic cover, MiniProx Reader (Rev. E) - Beige
5365-371-03	Classic cover, MiniProx Reader (Rev. E) - Black
5365-371-04	Classic cover, MiniProx Reader (Rev. E) - White
New Look¹	
5365-372-01	Designer cover, MiniProx Reader (Rev. E) - Black
5365-372-02	Designer cover, MiniProx Reader (Rev. E) - Charcoal Gray
5365-372-04	Designer cover, MiniProx Reader (Rev. E) - Wave Blue
5365-372-05	Designer cover, MiniProx Reader (Rev. E) - White
ThinLine II	
5395-104-01	Classic cover, ThinLine II Reader (Rev. C) - White
5395-104-02	Classic cover, ThinLine II Reader (Rev. C) - Beige
5395-104-03	Classic cover, ThinLine II Reader (Rev. C) - Black
5395-104-04	Classic cover, ThinLine II Reader (Rev. C) - Charcoal Gray
New Look²	
5395-371-01	Designer cover, ThinLine II Reader (Rev. C) - Black
5395-371-02	Designer cover, ThinLine II Reader (Rev. C) - Charcoal Gray
5395-371-04	Designer cover, ThinLine II Reader (Rev. C) - Wave Blue
5395-371-05	Designer cover, ThinLine II Reader (Rev. C) - White



Part Number	Description
MaxiProx	
5370A-305-01	Cover, MaxiProx Reader (Rev. A) - Gray
5375-303-01	Accessory Kit, MaxiProx Reader (Old wiring Diagram) (Rev. A)
5375-313-01	Accessory Kit, MaxiProx Reader (New wiring Diagram) (Rev. A)
56-0002-01	MaxiProx Reader Rubber Gasket (Rev. A)
ProxPoint Plus	
6005-111-01	Classic cover, ProxPoint Plus Reader (Rev. B) - White
6005-111-02	Classic cover, ProxPoint Plus Reader (Rev. B) - Beige
6005-111-03	Classic cover, ProxPoint Plus Reader (Rev. B) - Black
6005-111-04	Classic cover, ProxPoint Plus Reader (Rev. B) - Charcoal Gray
New Look³	
6005-312-01	Designer cover, ProxPoint Plus Reader (Rev. B) - Black
6005-312-02	Designer cover, ProxPoint Plus Reader (Rev. B) - Charcoal Gray
6005-312-04	Designer cover, ProxPoint Plus Reader (Rev. B) - Wave Blue
6005-312-05	Designer cover, ProxPoint Plus Reader (Rev. B) - White
Other	
4045-390-03	EntryProx Spare Parts Accessories Kit
4045-303-01	EntryProx Reader Replacement Antenna
6020-302-01	Accessory Kit, HSM
33-0001-01	RELAY, 1.00A-24VDC , SPDT-1 FO
57-0001-02	Key Ring for ProxKey® (Keyfob)

¹ MiniProx Covers will only fit MiniProx readers with removable covers series (Model # 5365E or later), and will NOT fit older versions with electronics potted into the cover (Model #s 5365A, 5365B, nor 5365C).

² Thinline II Designer Covers will only fit Thinline II readers (Model # 5395C or later), and will NOT fit Thinline II readers (Model #s 5395A nor 5395B).

³ ProxPoint Plus Designer Covers will fit all ProxPoint Plus readers (Model # 6005B or later), and will NOT fit ProxPoint readers (Model # 6005A).

Indala Proximity Readers

Overview

Every part number consists of a base model number to indicate the type of product, and a letter or number to indicate each product option. Each product has a standard part number that includes default options, as indicated on the order guide. When an order is placed for a product, the base model number and all options must be specified. If you require any options that are different from the default options, you must also indicate those options at the time the order is placed. All part numbers must be complete to be accepted by HID's order entry system.

All reader orders must have the following information:

- BASE MODEL NUMBER
- STYLE
- READ RANGE
- TYPE
- COLOR
- OUTPUT FORMAT (reader's format or format number must also be given at time of order)

Advantage Series Reader - ASR 620

Reader Model	Description	Notes
ASR-620++	Long Range Reader	
ASR-620++/L	Long Range Reader	w/10 foot (3 meter) cable

FlexPass Reader - FP Arch / Keypad



BASE NUMBER

FP = FlexPass (reader format required)

STYLE

- 3 = Arch
- 5 = Keypad
- 0 = Core Electronics Module

READ RANGE

- 5 = 5 in. (13 cm.) - available in STYLES: Arch, TYPES: Slim and Wall switch
- 2 = 12 in. (30 cm.) - available in STYLES: Arch TYPE: Midrange
- 0 = 4 in. (10 cm.) - available only in STYLE: Keypad; TYPE: Keypad

TYPE

- 1 = Slim - available in STYLES: Arch
- 2 = Wall switch - available in STYLES: Arch
- 3 = Midrange - available in STYLES: Arch
- 6 = Membrane Keypad - available only in STYLE: Keypad
- 0 = Module only

COLOR

- 1 = Black - available in STYLES: Arch TYPES: Slim, Wall switch, Midrange, Classic
- 0 = N/A

OUTPUT FORMAT

Note: Aside from choosing below, specify reader's format or format no. (e.g. 26-bit Wiegand or format no. 10022).

- A = Standard Wiegand - available in all STYLES and TYPES
- S = Serial - available in STYLES: Arch TYPE: Midrange
- B = Buffered or 8-Bit Burst (must be specified) - available only in Keypad STYLE and TYPE (Membrane or Heavy Duty)
- M = 3 x 4 Matrix

CABLE LENGTH

The default cable length for Indala modules is 18 inches (46 cm). No entry is needed for an 18 inch cable.

For Reader Cores an optional 10 ft (3 m) pigtail is available through the HID European, America and Asia Pacific offices. Requires a minimum 2,500 unit order quantity. Place /L in the 7th position for ordering the 10 ft (3 m) cable.

Note: Do not order Reader Packages with the 10 ft (3 m) cable. When ordering the 10 ft (3 m) cable, bezels must be ordered separately. Call Customer Service for assistance.



FlexPass Accessories

Part Number	Description
21211-001	Enclosure Base, ASR-620
21212-001	Enclosure Cover, ASR-620++
FPZ1231A	Bezel Wave Style, Midrange Type, Black
FPZ1234A	Bezel Wave Style, Midrange Type, Blue
FPZ1511A	Bezel Wave Style, Slim Type, Black
FPZ1514A	Bezel Wave Style, Slim Type, Blue
FPZ1521A	Bezel Wave Style, Wallswitch Type, Black
FPZ1524A	Bezel Wave Style, Wallswitch Type, Blue
FPZ2511A	Bezel Curve Style, Slim Type, Black
FPZ2521A	Bezel Curve Style, Wallswitch Type, Black
FPZ3231A	Bezel Arch Style, Midrange Type, Black
FPZ3235A	Bezel Arch Style, Midrange Type, Grey
FPZ3236A	Bezel Arch Style, Midrange Type, White
FPZ3237A	Bezel Arch Style, Midrange Type, Beige
FPZ3511A	Bezel Arch Style, Slim Type, Black
FPZ3515A	Bezel Arch Style, Slim Type, Grey
FPZ3516A	Bezel Arch Style, Slim Type, White
FPZ3517A	Bezel Arch Style, Slim Type, Beige
FPZ3521A	Bezel Arch Style, Wallswitch Type, Black
FPZ3521H	Bezel Arch Style, Wallswitch Type, Black (HID)
FPZ3525A	Bezel Arch Style, Wallswitch Type, Grey
FPZ3526A	Bezel Arch Style, Wallswitch Type, White
FPZ3527A	Bezel Arch Style, Wallswitch Type, Beige
FPZ3527H	Bezel Arch Style, Wallswitch Type, Beige (HID)
FPZ4511A	Bezel Linear Style, Slim Type, Black
FPZ-4511A	Bezel Linear Slim Black Cover
FPZ4517A	Bezel Linear Style, Slim Type, Beige
FPZ4521A	Bezel Linear Style, Wallswitch Type, Black
FPZ4525A	Bezel Linear Style, Wallswitch Type, Grey
FPZ4526A	Bezel Linear Style, Wallswitch Type, White
FPZ4527A	Bezel Linear Style, Wallswitch Type, Beige
FPZ4551A	Bezel Linear Style, Slim Type, Black
FPZC1511H	Bezel, HID, Wave, Slim,5, Black
FPZC1514H	Bezel, HID, Wave, Slim, 5, Blue
FPZC1524H	Bezel, HID, Wave, Wallswitch, 5, Blue
XXZ112	Bezel, Wave, Slim, 5, Blue
XXZ122	Bezel, Wave, W/S, 5, Blue
XXZ321	Bezel, Arch, W/S, Black
SH-003	Indala Credentials Special Handling, New marking label codes

Section 02

HID Mobile Access



What is Mobile Access from HID?

HID Mobile Access® complements any access control solution by enabling building occupants to securely access the facility using Android and iOS mobile devices. HID Mobile Access, powered by Seos®, consists of the following components:

- **HID ORIGO™ Management Portal:** A cloud-hosted management portal that allows administrators to manage users, devices, and securely issue/revoke Mobile IDs.
- **Mobile end point:**
 - **HID Mobile Access app:** Easily downloaded on [Google Play](#) and [Apple App Store](#) and proven compatibility with the most popular mobile phones, tablets, and wearables.
 - **HID Technology Partner app:** With support for mobile access. For example, solutions for commercial real estate/prop tech, building automation and controls, app consolidation for corporations, and more.
 - **Mobile Wallet:** Currently supporting Apple Wallet and Google Wallet.
- **Mobile IDs:** Powered by Seos credential technology, Mobile IDs are the virtual equivalent of the traditional contactless smart card.
- **Signo™ iCLASS SE® and multiCLASS® SE Readers:** These flexible readers can be configured to securely authenticate with an organization's Mobile IDs via Bluetooth Smart and/or NFC communication standards.

Creating a HID Mobile Access User Account

In order to use HID Mobile Access, an account in the HID Origo Management Portal is required. Once an end user account has been created, the organization will be able to order products from its Access Control Provider and issue Mobile IDs to its building occupants.

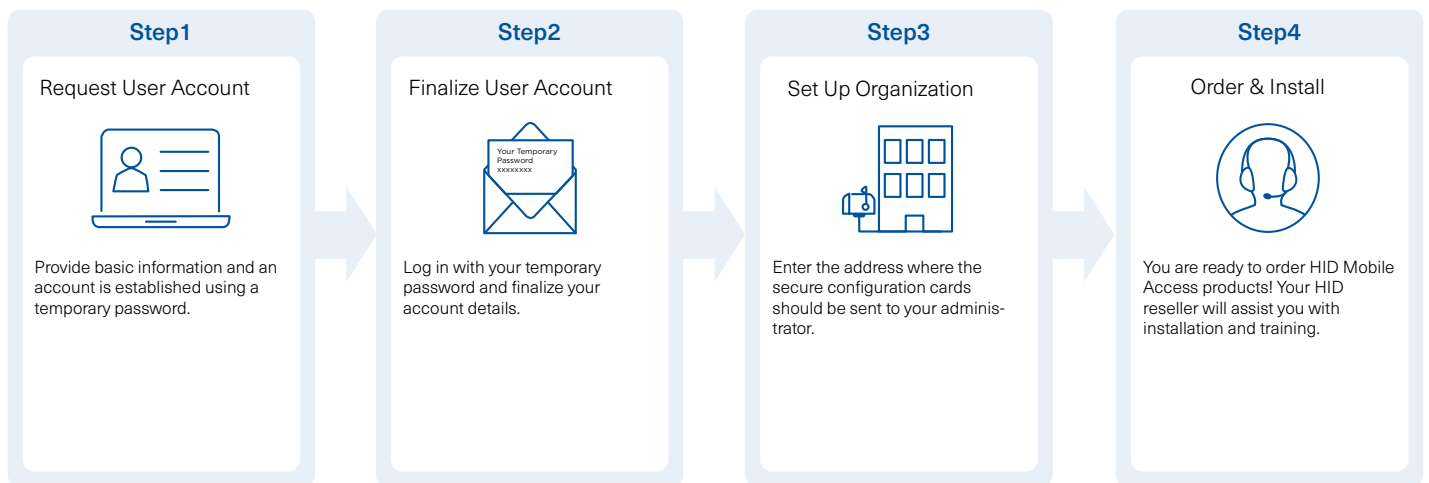

To set up an end-user account please go to <https://portal.origo.hidglobal.com/selfonboarding>

After user account creation, the administrator will be given organization-specific identifiers required for ordering and for secure portal access:

Identifier	Description
Mobile Keypad (MOB or ICE)	Mobile Keypad is a reference number for a set of cryptographic keys loaded into a reader. Mobile IDs, Mobile Key cards, and Mobile Admin cards will securely authenticate only with readers programmed with a matching keypad. An organization is assigned a Mobile Keypad upon registration into either the HID Elite (ICE) or HID Mobile Access (MOB) programs. The correct Mobile Keypad must be supplied when ordering mobile-enabled readers, Mobile IDs, subscription user licenses, Mobile Key cards, and Mobile Admin cards.
Organization ID	Organization ID is a reference number for a unique account within the HID Origo Management Portal. It is assigned at the conclusion of account registration. The correct Organization ID must be supplied when ordering Mobile IDs, subscription user licenses, and Mobile Admin cards.

Selecting the Right Mobile Access Subscription Type

HID Origo Mobile Identities is a Software as a Service (SaaS) model where you purchase subscription user licenses.

The differences between the three tiers of product subscriptions are noted in the feature matrix below. Note that these tiers are not available in all the product subscriptions.

Features	Essentials	Enterprise	Premium
Platform Service			
Formats per org	1	Unlimited	Unlimited
MOB keys per org	1	Unlimited	Unlimited
# Credentials per user	1	10	10
# Devices per user	1	5	5
Opening features			
Tap	Yes	Yes	Yes
Twist & Go	No	Yes	Yes
Widget	No	Yes	Yes
NFC on iOS	No	No	Yes
Portal features			
Photo ID	Yes	Yes	Yes
Enterprise policy enforcement	No	Yes	Yes
Custom Data	No	Yes	Yes
Analytics	No	Yes	Yes
Custom invitation email	No	Yes	Yes
Credentials in Apple wallet	No	No	Yes

HID Mobile Identities Part Numbers

Currently there are two types of contract for purchasing subscription user licenses:

Prepaid Subscription

You purchase a set of subscription user licenses which is then consumed as you activate users (active credentials in their device). The Minimum Order Quantity (MOQ) for the Purchase Order (PO) is 20. Your subscription will be automatically renewed unless otherwise stated. There are three period terms, one year, three years, or five years.

HID offers three tiers of product subscriptions, **Essentials**, **Enterprise**, and **Premium**. Note that you can only subscribe for one tier.

Essentials 1 year	MID-SUB-T050	Enterprise 1 year	MID-SUB-T100
Essentials 1 year add on users	MID-SUB-T050-ADD	Enterprise 1 year add on users	MID-SUB-T100-ADD
Essentials 3 year	MID-SUB-T053	Enterprise 3 year	MID-SUB-T103
Essentials 3 year add on users	MID-SUB-T053-ADD	Enterprise 3 year add on users	MID-SUB-T103-ADD
Essentials 5 year	MID-SUB-T055	Enterprise 5 year	MID-SUB-T105
Essentials 5 year add on users	MID-SUB-T055-ADD	Enterprise 5 year add on users	MID-SUB-T105-ADD

Activation Based Subscription

You place a Purchase Order (PO) with an order quantity equal to 1, just to establish the contract, the part numbers below, and the pricing. The subscription will be indefinitely valid until year 2099. You will be charged monthly, in-arrears, only for users that have an active mobile access credential in their device at some point during the invoiced calendar month.

HID offers two tiers of product subscriptions, **Enterprise** and **Premium**, and you are automatically subscribed for both.

Enterprise 1 month	MID-ACT-T100
Premium 1 month	MID-ACT-T200
Apple fee 1 year	FEE-AAPL-01



Ordering Information – Readers for HID Mobile Access

Component	Details	Part Number	Supplemental Information Needed for Order	
<p>Mobile-Ready Readers</p>	<p>Mobile-Ready readers are prepared to support HID Mobile Access but lack the personalized configuration (Mobile Keypad) to read an organization's specific Mobile IDs. These readers can be ordered at any time but will require field activation after the organization has completed registration for HID Mobile Access. To support a specific organization's Mobile IDs, these readers need to be personalized (Mobile Keypad loaded) using a Mobile Key Card or HID Reader Manager mobile application.</p>	<p>See HID Signo Readers, iCLASS SE Readers</p>		
<p>Mobile-Enabled Readers</p>	<p>Mobile-Enabled readers are fully activated and personalized to support an organization's specific Mobile IDs. These readers can only be ordered after the organization has completed registration for HID Mobile Access or HID Elite program. MOB or ICE Mobile Keypad will be required at time of order.</p>	<p>See HID Signo Readers, iCLASS SE Readers</p>	<p>MOB or ICE: _____</p> <p>Org Name: _____</p>	
<p>Mobile Key Card</p> <p>Note: Only suitable for iCLASS SE Readers (Use HID Reader Manager for HID Signo)</p>	<p>Configuration card used to personalize and activate a Mobile-Ready reader; converting it to a Mobile-Enabled reader.</p>	<p>SEC9X-CRD-E-MKYD</p>	<p>MOB or ICE: _____</p> <p>Org Name: _____</p>	



Ordering Information – Mobile Identities Service

Natively tracked formats (e.g. Corporate 1000™) are strongly recommended. Since HID will automatically generate and replenish Mobile IDs, the user license subscription model requires a tracked credential format – a format in which HID tracks the credential number to ensure no duplicates are ever created. To guarantee no collision with credential numbers on traditional cards, the same format should be used for both Mobile IDs and cards.

Prepaid One & Three Year User License Subscriptions			
Order Type	Details	Part Number	Supplemental Information Needed for Order
Initial Order	When starting a one or three year subscription for HID Origo Mobile Identities, an order for User Licenses must be placed. The Minimum Order Quantity (MOQ) is 20. The service start date begins on the date the order is processed by HID. User Licenses will be valid for one or three years and the service term end date will be set to the last day of month.	1-year subscription MID-SUB-T050 MID-SUB-T100 3-year subscription MID-SUB-T053 MID-SUB-T103 5-year subscription MID-SUB-T055 MID-SUB-T105	Org ID: Org Name: MOB or ICE: Format*: Subscription Start Date: (Optional) (DD MMMM, YYYY)
Adding Additional User Licenses	To increase the number of User Licenses within a service term, an order for add-on licenses must be placed. These user licenses will have a prorated price based on the number of whole months remaining in term. They will co-terminate and expire along with previously purchased licenses on the contract.	1-year subscription MID-SUB-T050-ADD MID-SUB-T100-ADD 3-year subscription MID-SUB-T053-ADD MID-SUB-T103-ADD 5-year subscription MID-SUB-T055-ADD MID-SUB-T105-ADD	Org ID: Org Name: Contract ID: Subscription Start Date: (Optional) (DD MMMM, YYYY)
Changing subscription tier or term midterm	Upgrading from MID-SUB-T05x to MID-SUB-T10x during a subscription term is possible under certain circumstances, e.g. upgraded tier with the same or more end users. This will result in the cancellation of the original contract line, crediting the remaining term time, and generation of a new contract line on the same contract with the upgraded item. Note: An organization cannot be on more than one subscription plan simultaneously. Downgrading from MID-SUB-T10x to MID-SUB-T05x can only be completed at the time of renewal.	Upgrade from MID-SUB-T050 to MID-SUB-T100: MID-SUB-T100-UPG Upgrade from MID-SUB-T053 to MID-SUB-T103: MID-SUB-T103-UPG Upgrade from MID-SUB-T055 to MID-SUB-T105: MID-SUB-T105-UPG	Org ID: Org Name: Contract ID: Subscription Start Date: (Optional) (DD MMMM, YYYY)
Adding additional credential types	If, after initial onboarding account creation, a new credential type is needed (new format and/or keyset), an order must be placed. Quantity should always be 1. There is no charge for this transaction as unlimited credentials are included with subscription user licenses.	MID-SUB-CRD	Org ID: Org Name: MOB or ICE: Format*:
Renewal	When renewing a subscription for HID Origo Mobile Identities service, an order for User Licenses must be placed. A change in HID reseller will generate a new contract ID.	1-year subscription MID-SUB-T050 MID-SUB-T100 3-year subscription MID-SUB-T053 MID-SUB-T103 5-year subscription MID-SUB-T055 MID-SUB-T105	Org ID: Org Name:
Changing subscription tier or term at the renewal date	To change between subscription plans at renewal, please order the corresponding part number and the number of licenses needed. This will generate a new contract ID.	1-year subscription MID-SUB-T050 MID-SUB-T100 3-year subscription MID-SUB-T053 MID-SUB-T103 5-year subscription MID-SUB-T055 MID-SUB-T105	Org ID: Org Name: MOB or ICE: Format*:



Activation Based Subscriptions			
Order Type	Details	Part Number	Supplemental Information Needed for Order
Initial Order	When starting an Activation Based subscription for HID Origo Mobile Identities, an order for User Licenses must be placed with an order quantity equal to 1, just to establish the contract, the part numbers, and the pricing. The service start date begins on the date the order is processed by HID. User Licenses will be indefinitely valid and the service term end date will be set to 2099. Monthly in arrears invoices will be automatically sent regarding the monthly consumption for the previous calendar month.	1-month subscription MID-ACT-T100 MID-ACT-T200 1-year Apple fee FEE-AAPL-01	Org ID: Org Name: MOB or ICE: Format*: Subscription Start Date: (Optional) (DD MMMM, YYYY)

Preparing for Renewal

For your convenience, subscription contracts can be set to auto or manual renewal. For those with manual renewals it's important that any changes are captured, that key information is supplied, and that the renewal order is placed early enough to be processed by HID prior to the expiration date. We recommend that end user administrators place renewal orders with their HID resellers at least a month prior to expiration.

Should you have any questions, the HID Mobile Access FAQ is a great starting point.

https://doc.origo.hidglobal.com/faq/portal/HID_Mobile_Access_FAQ.pdf

To find your MOB-key, facility code, or format:

1. As an End User administrator, log in to the HID Origo Portal:
<https://cloudservices.hidglobal.com/mobile-identities/#/home>
2. Select the **Mobile Identities Services** option. This will take you to **Mobile Identities – Manage Users, Devices and Mobile IDs**. The organization summary section displays license information, including:
 - a. License counts e.g. Total, Active, and Available Licenses
 - b. Org ID

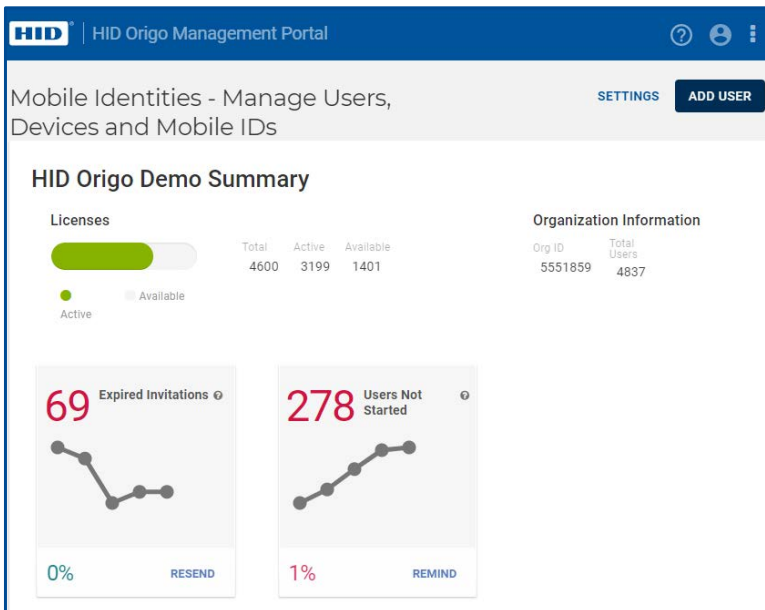

3. Information about your current MOB-key, facility code, and format is available in the **Mobile IDs** section. Hover over the card image to display all relevant information.

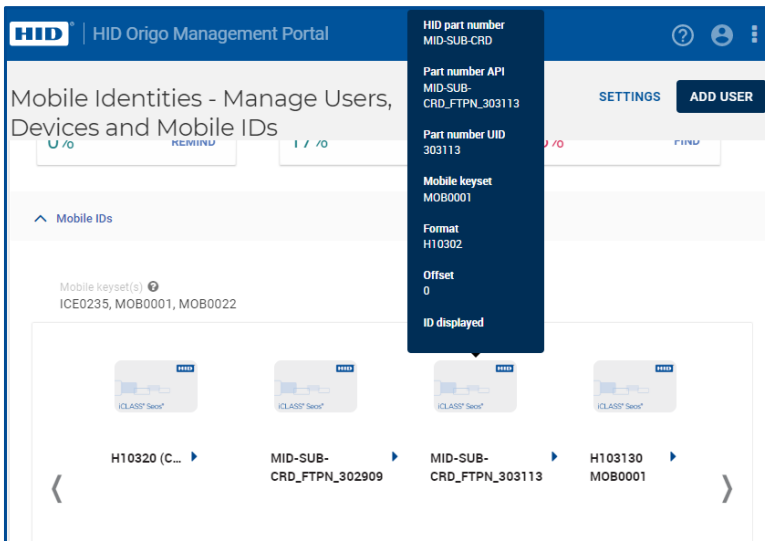

Note: To avoid delays, please include all relevant information when contacting your reseller.

Section 03

Credentials

Understanding HID Credentials

Can I configure my credential product online?

Yes, HID GLOBAL® is now offering the HID Global Product Configurator. This online tool will guide customers and partners toward the most suitable product for their needs. There are two main features available with this tool:

- **Find by part number** - allows customers to enter an existing part number to see the specification of this credential.
- **Build a credential** - helps customers construct a complete part number, including keyset and formatting information; everything needed to place an order. Customers will be able to download a PDF with all specifications of the credential they build to allow for a smooth ordering process.

HID Global Product Configurator: <https://www.hidglobal.com/configure>

What should I know about security keysets?

HID Signo™, iCLASS SE® readers and Seos® / iCLASS SE credentials offer two keyset security schemes, HID Elite and Standard.

The **HID Elite Security Program** supports a unique keyset on a per site/company basis.

The keyset governs a variety of keys, including:

- Media (credential) keys for iCLASS SE, SIO®-encoded iCLASS, MIFARE Classic (SIO) and MIFARE DESFire EV1/EV3 (SIO) credentials.
- SIO authenticity and privacy keys (media independent).
- Admin/configuration programming keys (for programming reader configuration, also media independent).

When utilizing HID’s standard key set for the above keys, all standard keyed credentials work with all standard keyed readers. Additionally, any Standard Security configuration card configures a Standard Security reader (only accomplished during the first five (5) seconds after reader powers-up). Conversely, when utilizing the HID Elite program, only site/company specific HID Elite credentials and configuration cards work with matching readers.

The **Standard Security Program** provides universal keysets that offer maximized compatibility by keying readers and cards with matching security for use in the general population. This allows for maximized compatibility because readers and cards are not keyed on a per site/company basis but rather all keyed the same. This offers the advantage to the integrator as a standard stock of readers and cards will interoperate for a variety of sites/companies, rather than needing different stocks of readers and cards for each individual site. iCLASS SE readers provide two Standard Security Keysets that offer compatibility with the following credentials:

Standard Security Keyset	Compatibility with these Credentials
Version 1	<ul style="list-style-type: none"> • Seos (+ Prox) • iCLASS SE (+ Prox) • iCLASS SIO encoded (+ Prox) • iCLASS (+ Prox) • MIFARE Classic (+ Prox) • MIFARE DESFire EV1/EV3 (+ Prox)
Version 2	<ul style="list-style-type: none"> • Seos (+ Prox) • iCLASS SE (+ Prox) • MIFARE Classic (+ Prox) • MIFARE DESFire EV1/EV3 (+ Prox)

How can I order HID Elite configured credentials?

- Direct customers of HID must be authorized to purchase components with HID Elite keys. If you are not authorized, you must have the key owner authorize you through the Authorization form.
- See <https://www.hidglobal.com/solutions/elite-key>
- Ensure the HID Elite flag is set in the part number (of readers, credentials and configuration cards).
- All Purchase Orders for HID Elite components must be ordered with the HID Elite reference number (starts with ICE).

How can I migrate from my current credential technology?

- **iCLASS Existing Sites:** When deploying credentials to an existing site with standard iCLASS credentials and readers the following steps provide a guideline to a recommended path:
 1. Purchasing Seos + iCLASS cards along with HID Signo Readers - Smart Profile credential support (supporting iCLASS cards), as this provides full interoperability with HID's latest credential and reader platform, as well as supporting installed iCLASS base.
 2. This provides options to upgrade security in the future without rip-and-replace of the newly purchased readers.
 3. Once all readers on site are HID Signo the customer can begin ordering Seos only cards.
 4. Once all cards in the population are Seos, readers can be configured to support only Seos cards.
- **125 kHz Existing Sites:** Deploying credentials to an existing 125 kHz site with HID Prox/Indala Proximity credentials and readers (HID, Indala, AWID, and EM4102), purchase multi-technology Seos or iCLASS SE Credentials, along with HID Signo - Standard Profile Readers for full credential and reader interoperability, and a relaxed migration timeline.





What is the difference between Seos, iCLASS SE and iCLASS credentials?

Seos credentials deliver enhanced security, data confidentiality and stronger authentication for user data. Seos comprises a generic card edge (card command interface) to meet the growing demand for interoperability; a secure messaging protocol to protect data transmission. In addition, Seos provides an open software architecture that is portable to a range of mobile devices and microprocessors. The credential offers enhanced privacy protection in its delivery of data between the smart card and the reader which helps to prevent sensitive/personal data from being intercepted or cloned. Seos credentials are only delivered with a single access control data payload, the SIO, and are not backwards compatible with iCLASS readers.

iCLASS SE credentials come with a single access control data payload, the SIO. iCLASS SE credentials are designed to work in an installation of HID Signo and iCLASS SE readers only and are not backwards compatible with iCLASS readers.

iCLASS credentials are offered either with or without an encoded SIO. For the SIO encoded option, this card will come with two access control data payloads: the SIO and iCLASS access control data payload. These credentials provide backward compatibility with currently deployed systems, maximizing compatibility. iCLASS credentials encoded with SIO should be purchased when the site needs legacy application support, or when the site plans to eventually migrate to SIO security. iCLASS credentials encoded with SIOs were previously marketed as iCLASS SR credentials.

iCLASS credentials are designed to work in an existing installation of standard iCLASS readers. iCLASS credentials are compatible with iCLASS, HID Signo and iCLASS SE readers.*

Credential Type	Works with HID Signo and iCLASS SE Readers*	Works with iCLASS Readers	Advantage
 <p>Seos</p>	Yes	No	Advanced security and privacy protection, programmable card, portability, interoperability (standards based) and usability (read range).
 <p>iCLASS SE</p>	Yes	No	Increased Security
 <p>iCLASS, SIO encoded (Previously called iCLASS SR)</p>	Yes (reading SIO or standard iCLASS access control application)	Yes (Reading standard iCLASS access control application)	Increased Security when reading SIO, maximum compatibility - works with iCLASS, HID Signo and iCLASS SE readers.
 <p>iCLASS, without SIO encoding</p>	Yes	Yes	

* Reader support depends on reader model and configuration selected.

Credentials Marking

Standard physical credentials are printed with the HID logo (with basic technology identifiers) and dynamic (laser marked) information such as the sales order number, format ID number range (e.g., matching, non-matching etc.), along with other additional markings used to identify certain programming attributes. For information on card identification markings, please see, please see *HID Global Credential Identification Markings Application Note* (AN0109).

Non-Matching ID Number Marking

If you wish to order a non-programmed credential (such as Seos genuine media “V” part number or unprogrammed DESFire EV3) but would like a printed number range (for example, to match later field programmed values), please select the sequential, non-matching part number option and provide the desired printed range on your order.

Sales Order Number Marking

Regardless of the programming option selected, most credentials include a printed sales order number; if you do not want the sales order number printed, please request a custom part number through your local HID customer service team.

Credential Marking Technology

As a part of our commitment to continuous enhancements of world-class products and solutions, HID Global has completed the transition to laser card marking technology.

This state-of-the-art laser engraving technology results in a more appealing look and feel and reduces the ecological footprint of card production.

Key benefits:

- Marking quality and durability of the cards will be enhanced and more consistent.
- New engraving technology reflects HID Global’s commitment to sustainability by eliminating the use of solvents.
- Improved Proof-of-Authenticity since engraved markings cannot be removed or modified.

Existing Inkjet Part Numbers

HID will continue to supply ink jet-based part numbers but with laser marking as we have been doing already, in many locations. Over time we will phase out ink jet part numbers and replace them with laser marked part numbers. No action is required at this time, you may continue to order ink jet part numbers.

Understanding Credential Formats

The majority of physical access control credentials are programmed with an access control data “format”. The format of the credential is sent to the controller by the reader and must match the format of the access control system. In some cases, the format of the credential must also match the format of the reader before an output is sent.

Format Structure

Each format differs in structure by:

- Bit length (for example, 26 bits, 37 bits)
- Number of fields (for example, H10301 26-bit has two fields; ID range and facility code)
- Field names (for example, facility code, site code, ID range etc.)
- Field length (for example H10301 26-bit has a 16-bit ID range and 8-bit facility code)
- Parity

Many formats share the same bit length but differ in structure and for this reason it is not possible to determine the required format number from the bit length alone. If an incorrect format is programmed into the card may not operate correctly with the access control system.

What format do I need?

Existing Systems

If you are ordering cards for an existing system you must determine the format of the existing cards. The format number can be found in the original HID order acknowledgement information or card packaging. Most credentials are marked with the sales order number (see image below) allowing you to contact your local HID Global customer service team for information. HID Global will refer sales order number based enquiries to the order originator so that the format details can be established. Information relating to OEM/proprietary, end-user or other controlled formats will not be released to unauthorized parties.

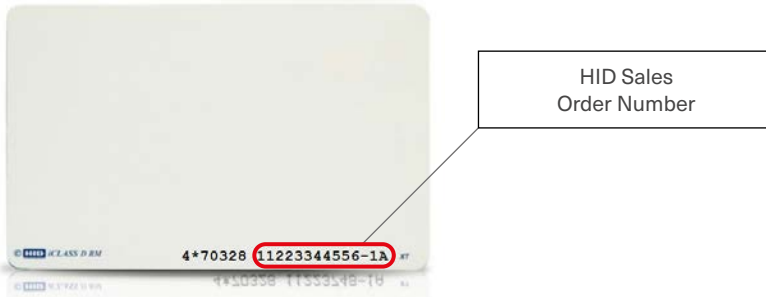

New Systems

HID Global offers a range of open, tracked, end-user (Corporate 1000™) and OEM/proprietary formats. Contact your local sales or pre-sales representative for additional guidance.

Corporate 1000

HID Global's Corporate 1000 Program offers a fully managed end-user controlled solution for RFID card formatting and card number tracking. The Corporate 1000 Program benefits end-users with multiple locations and/or decentralized decision-making for card purchases. This alternative to in-house card production offers a variety of benefits including increased security and management of issuance over multiple purchasers or locations.

Key Benefits

- Card and associated data is more secure when programmed with a unique format.
- HID Global's managed service tracks card number sequences to prevent card number duplication.
- Choose to have one authorized source of supply or many; card numbers will not be duplicated.

See: <https://www.hidglobal.com/solutions/corporate-1000>

Common Formats

HID has many active Corporate 1000, OEM and open formats. A list of common formats is detailed below.

Format Number	Description	Additional Fields	Number Range
H10301	Open 26-bit with Facility Code and ID Number	Facility Code (0-255)	0-65535 (untracked)
H10302	Tracked 37-bit ID Number	N/A	0-34359738368 (tracked)
H10304	Tracked 37-bit with Facility Code and ID Number	Managed Facility Code (0-65535)	
H10320	Open ABA 8 digit ID Number	N/A	0-99999999 (untracked)
Starts with "H5"*	35-bit Corporate 1000	Fixed Company ID Code	0-1048575 (tracked)
Starts with "H2"*	48-bit Corporate 1000	Fixed Company ID Code	0-8388607 (tracked)

Untracked formats require the customer to specify the ID range, for example, H10301 and H10320 require customers to specify the required ID range. Tracked formats allow customers to request the next unused numbers, for example HID Global tracks H10302, H10304 and all Corporate 1000 formats.

* Prior to March of 2015, all Corporate 1000 formats were assigned using the 35 bit structure. From March 2015 all Corporate 1000 formats use a 48 bit structure. No new H5 formats will be created although they remain available. For further information refer to [HID Corporate 1000 Program Frequently Asked Questions \(PLT-02372\)](#).

Format Compatibility

HID Global formats for example H10301, H10302 and Corporate 1000 are compatible across multiple credential product lines such as Seos, iCLASS SE, CLASS, UHF, HID Prox and Mobile Access. However, some formats are product line specific. Refer to the table below for details.

Indala Formats – Label Code

Indala formats may be programmed into traditional HID Prox credentials, **however E code markings are not compatible**; choose marking options per the selected part number. Request a custom part number to meet specific marking requirements. **If a credential is encoded with an Indala format, an Indala compatible reader is required.**

Format Type	Example Format Numbers	Compatible Credential Product Lines – includes multi-technology credentials containing the listed technology.	Reader Compatibility
HID	H10301,H10302, H10304, 35-bit Corporate 1000 & OEM formats	HID Prox	HID Prox/HID Signo/MultiCLASS SE
		iCLASS, iCLASS SE, Seos	HID Signo/iCLASS SE
		MIFARE Classic with SIO encoding	HID Signo/iCLASS SE
		MIFARE DESFire with SIO encoding	HID Signo/iCLASS SE
		Mobile Access IDs	Mobile Enabled iCLASS SE
		UHF	UHF (U90®)
HID ABA	H10320	HID Prox	HID Prox/HID Signo/multiCLASS SE
Indala Prox 125 kHz	40134, 4038X	Indala Prox, HID Prox	Indala
Indala CX (Casi 125 kHz)	C10106	Indala CX, HID Prox	Legacy Indala Casi CX (discontinued) / third party Casi compatible
EM	EM4102	Contact your local HID Global pre-sales or sales engineering representative to discuss requirements	HID Signo/multiCLASS SE / third party
Custom MIFARE DESFire EV1/EV3 or MIFARE Classic	–	Contact your local HID Global pre-sales or sales engineering representative to discuss custom format requirements	–

Long Formats (HID Prox)

Not all products support HID Prox credentials encoded with formats longer than 37-bits (including Corporate 1000 48-bit).

HID Prox Format Type	Example Format Numbers	Compatible HID Prox Product Lines	Incompatible Products
Long Formats (>37-bits)	H2xxxxx 48-bit Corporate 1000, all other formats >37 bits	6005/6008/5365/5368/5355/5358/5395/ 5375 (manufactured after 2001)	eProx Lock, Serial ProxPro®, EntryProx™, ProxPass™ II

Understanding Credential Programming

How do I complete the programming section correctly?

For any given credential part number where a programmed option is selected you will need to enter the format number, field names (where applicable) and programming values into the programming section. If ordering a dual or triple technology credential complete the programming section for each technology. Mandatory fields depend on the part number selected.

Mandatory Programming Information

- **Format number** Required for all programmed part numbers
- **Format field names** Required for formats with additional fields
- **HID Elite ICE number** If required to support a matching HID Elite ICE reader

Mandatory Marking Information

- **Printed number range:** Required for all external matching or non-matching options

Examples

Part Number: **5006PGGAN (programmed Seos, matching external marking)**
 Quantity: **500**
 Format: **H10301**
 Facility Code: **125**
 ID number range: **25,001 to 25,500**

Format Number	Field Name(s) e.g. Facility Code	Value	Quantity	Encoded Start Number	Encoded Stop Number
H10301	Facility Code	125	500	25,001	25,500
HID Elite ICE number				Printed Start Number	Printed Stop Number
				25,001	25,500

Part Number: **5006PGGNN (programmed Seos, no external marking)**
 Quantity: **1,000**
 Format: **O999123 (Custom OEM format with site code and installer code)**
 Elite Key: **ICE999**
 Site Code: **156**
 Installer Code: **21**
 Number range: **1,001 to 2,000**

Format Number	Field Name(s) e.g. Facility Code	Value	Quantity	Encoded Start Number	Encoded Stop Number
O999123	Site Code	156	1,000	1,001	2,000
HID Elite ICE number	Installer Code	21		Printed Start Number	Printed Stop Number
ICE999					

If you have any questions relating to credential technologies, marking, key management, formats or need help to complete your purchase order please contact HID Customer Service or your local sales representative.

Eco Credentials

Seos Bamboo Card manufactured with sustainable FSC certified natural bamboo - 574

Slot punched contactless smart card manufactured from sustainable FSC certified natural bamboo. Ensure each required option has been checked with the appropriate choice to fulfill a completed order form.

Base Model **574**

Memory Size

6 - 8K Bytes

Secure Identity Object Programming (Select one option)

- P** - Programmed with Secure Identity Object (SIO)
 V - Unprogrammed, for use with iCLASS SE Encoder

Front Packaging

G - Bamboo¹ with Seos logo

Back Packaging

G - Bamboo¹

Card Numbering² (Select one option)

- N** - No external ID number (SO Number not printed for this option)
 A - Sequential Matching Encoded/Printed (Laser Engraved)
 B - Sequential Encoded/Sequential Non-Matching Printed (Laser Engraved)
 C - Random Encoded/Non-Matching Sequential Printed (Laser Engraved)

Slot Punch

V - Vertical Slot Punch

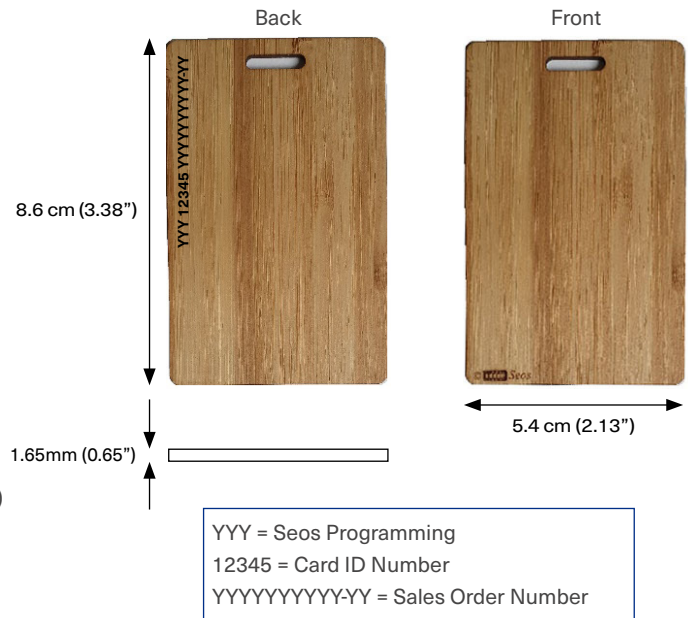

Enter your final card options from the check boxes above. Example: 5746PGGNV

Final Part Number	574	6		G	G	N	V
-------------------	-----	---	--	---	---	---	---

Seos Programming Information

Format Number	Field Name(s) e.g. Facility Code	Value	QTY	Encoded Start Number	Encoded Stop Number
HID Elite ICE				Printed Start Number	Printed Stop Number

¹ Bamboo is a natural material; variations in color and texture are expected.

² A sales order number and dynamic identifiers are printed on the card, unless indicated otherwise.

Available with 7 byte static UID for ISO14443A UID migration and interoperability. This feature reduces privacy and is not recommended. Contact your local sales or pre-sales representative for more information.

Seos Credentials

Note: See "Understanding HID Credentials" on page 56 for guidance.

Seos Card - 500

Increased security and interoperability cards for installation supporting HID Signo and iCLASS SE reader platform.

Ensure each required option has been checked with the appropriate choice to fulfill a completed order form.

Base Model **500 Composite 40% Polyester / PVC***

Seos Size and Allocation (select one option)

- 5 - 16K Bytes
- 6 - 8K Bytes⁶

Secure Identity Object™ Programming (select one option)

- P - Programmed with Security Identity Object (SIO)
- V - Unprogrammed, for use with iCLASS SE Encoder

Front Packaging (select one option)

- G - Plain White with Gloss Finish
- C - Custom Artwork with Gloss Finish - Specify Custom Artwork Number¹

Back Packaging (select one option)

- G - Plain White with Gloss Finish²
- C - Custom Artwork with Gloss Finish - Specify Custom Artwork Number¹
- 1 - Plain White with Gloss Finish with Magnetic Stripe²
- 3 - Custom Artwork with Gloss Finish with Magnetic Stripe - Specify Custom Artwork Number¹

Card Numbering³ (select one option)

- M - Sequential Matching Encoded/Printed (Inkjetted)⁵
- N - No Printed Card Numbering
- S - Sequential Encoded/Sequential Non-Matching Printed (Inkjetted)⁵
- R - Random Encoded/Non-Matching Sequential Printed (Inkjetted)⁵
- A - Sequential Matching Encoded/Printed (Laser Engraved)
- B - Sequential Encoded/Sequential Non-Matching Printed (Laser Engraved)
- C - Random Encoded/Non-Matching Sequential Printed (Laser Engraved)

Slot Punch⁴ (select one option)

- N - No slot punch, this card **cannot** be slot punched.
The below options apply to Seos 5006 (8K) ONLY:
- B - No slot punch, this card can be slotted horizontally or vertically (printed slot indicators)
- V - Vertical slot punch (shipped with vertical slot punch and horizontal slot indicator)
- H - Horizontal slot punch (shipped with horizontal slot punch and vertical slot indicator)

Packing (Optional)

- T - Packs of 10 (shrink wrap) in standard box

Option - Custom Artwork¹

- _____ (Specify Artwork Number - Refer to the Custom Artwork Forms for new artwork)

Enter your final card options from check boxes above. Example: 5005PGGNNT

Final Part Number	500					N		-	(Options #)
-------------------	-----	--	--	--	--	---	--	---	-------------

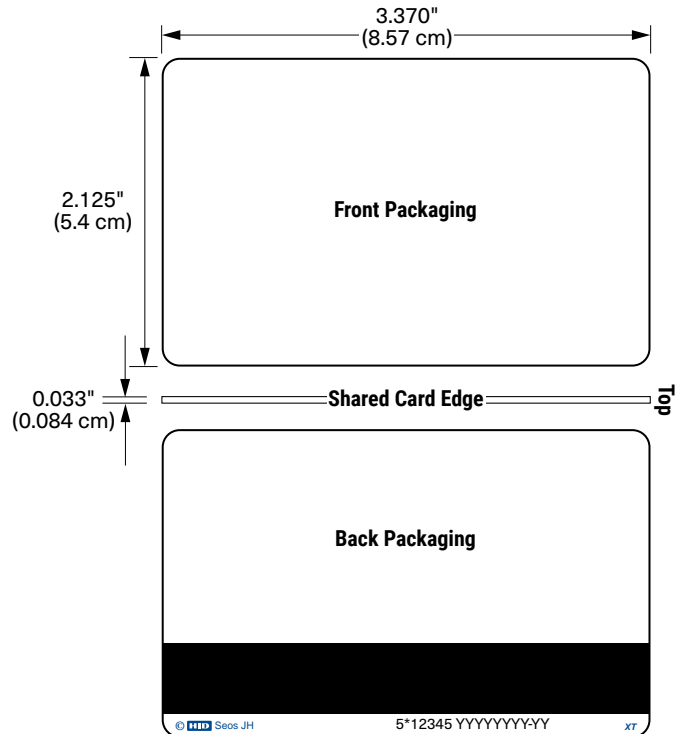

Y = Seos Programming
12345 = Card ID Number
YYYYYYY-YY = Sales Order Number



Seos Card Programming Information

Format Number	Field Name(s) e.g. Facility Code	Value	QTY	Encoded Start Number	Encoded Stop Number
HID Elite ICE #				Printed Start Number	Printed Stop Number

¹ For new artwork files, contact Customer Service for custom artwork number, lead-times, and cost.

² Cards ordered with plain white front and back packaging, or custom artwork, will still have a small HID logo  and reference number printed in the lower left-hand corner.

³ The Printed card number is placed in the bottom right-hand corner on the back of the card. Most part numbers are marked with the sales order number. A custom part number is required to omit all marking from the card. Contact your local support representative for details.

⁴ Cards are not available with any slot punch option.

⁵ Please note that cards shipped within North America are always laser-engraved. Inkjetted option is not available for these cards.

⁶ Available with 7 byte static UID for ISO14443A UID migration and interoperability. This feature reduces privacy and is not recommended. Contact your local sales or pre-sales representative for details.

Seos + iCLASS Card - 522

Migration solution from iCLASS to Seos in HID Signo or iCLASS SE reader platform.

Ensure each required option has been checked with the appropriate choice to fulfill a completed order form.

Base Model **522 Composite 40% Polyester / PVC***

Seos and Memory Size and Allocation

6 - 8K Bytes⁶

iCLASS Memory Size and Allocation (select one option)

- 0** - iCLASS 2k Bits (256 Bytes) with 2 Application Areas
- 3** - CLASS 32k Bits (4K Bytes) Application areas 16k/2+16k/1
- 4** - CLASS 32k Bits (4K Bytes) Application areas 16k/16+16k/1

Seos Programming (select one option)

- P** - Programmed with Security Identity Object (SIO)
- V** - Unprogrammed, for use with iCLASS SE Encoder

iCLASS Programming (select one option)

- S** - Programmed with Security Identity Object (SIO) and with standard iCLASS Access Control Application (**recommended**)
- P** - Programmed with Security Identity Object (SIO)
- H** - Programmed with standard iCLASS Access Control Application
- C** - Unprogrammed, for use with iCLASS SE Encoder

Front Packaging (select one option)

- G** - Plain White with Gloss Finish
- C** - Custom Artwork with Gloss Finish - Specify Custom Artwork Number¹

Back Packaging (select one option)

- G** - Plain White with Gloss Finish²
- C** - Custom Artwork with Gloss Finish - Specify Custom Artwork Number¹
- 1** - Plain White with Gloss Finish with Magnetic Stripe²
- 3** - Custom Artwork with Gloss Finish with Magnetic Stripe - Specify Custom Artwork Number¹

Seos Card Numbering³ (select one option)

- N** - No Printed Card Numbering
- A** - Sequential Matching Encoded/Printed (Laser Engraved)⁵
- B** - Sequential Encoded/Sequential Non-Matching Printed (Laser Engraved)⁵
- C** - Random Encoded/Non-Matching Sequential Printed (Laser Engraved)⁵

iCLASS Card Numbering³ (select one option)

- N** - No Printed Card Numbering
- A** - Sequential Matching Encoded/Printed (Laser Engraved)⁵
- B** - Sequential Encoded/Sequential Non-Matching Printed (Laser Engraved)⁵
- C** - Random Encoded/Non-Matching Sequential Printed (Laser Engraved)⁵

Slot Punch⁴

N - No Slot Punch

Option - Custom Artwork¹

_____ (Specify Artwork Number - Refer to the Custom Artwork Forms for new artwork)

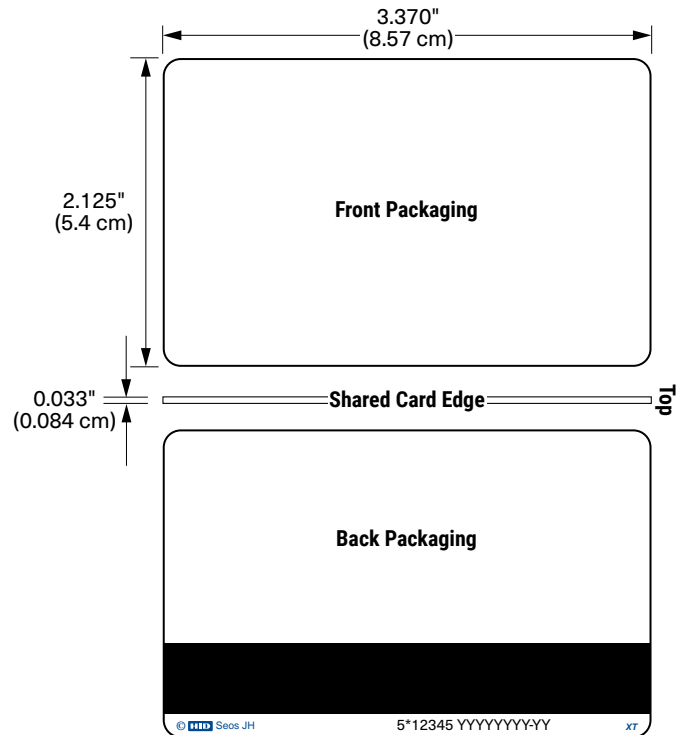

Y = Seos Programming
12345 = Card ID Number
YYYYYYY-YY = Sales Order Number



Enter your final card options from check boxes above. Example: 52263PSGGAAN

Final Part Number	522	6								N	-	(Options #)
-------------------	-----	---	--	--	--	--	--	--	--	---	---	-------------

Seos Card Programming Information

Format Number	Field Name(s) e.g. Facility Code	Value	QTY	Encoded Start Number	Encoded Stop Number
HID Elite ICE #				Printed Start Number	Printed Stop Number

iCLASS Card Programming Information

Format Number	Field Name(s) e.g. Facility Code	Value	QTY	Encoded Start Number	Encoded Stop Number
HID Elite ICE #				Printed Start Number	Printed Stop Number

¹ For new artwork files, contact Customer Service for custom artwork number, lead-times, and cost.

² Cards ordered with plain white front and back packaging, or custom artwork, will still have a small HID logo and reference number printed in the lower left-hand corner. Most part numbers are marked with the sales order number. A custom part number is required to omit all marking from the card. Contact your local support representative for details.

³ The Printed card number is placed in the bottom right-hand corner on the back of the card.

⁴ Cards are not available with any slot punch option.

⁵ Inkjetted option is not available for these cards.

⁶ Available with 7 byte static UID for ISO14443A UID migration and interoperability. This feature reduces privacy and is not recommended. Contact your local sales or pre-sales representative for details.

* The composite construction is recommended for all cards with over-laminate applied. Consult with the printer manufacturer prior to ordering.

Seos + Prox Card - 510

Migration solution from proximity to high security for support in HID Signo or iCLASS SE reader platform.

Ensure each required option has been checked with the appropriate choice to fulfill a completed order form.

Base Model **510 Composite 40% Polyester / PVC***

Seos Memory Size and Allocation (select one option)

- 5** - 16K Bytes
- 6** - 8K Bytes⁶

Programming (select one option)

- P** - Programmed with Security Identity Object (SIO), HID Prox non programmed
- R** - Both interfaces programmed: Seos with Security Identity Object (SIO), 125 kHz programmed with HID or Indala format
- V** - Unprogrammed Seos and HID Prox, for use with iCLASS SE Encoder

Front Packaging (select one option)

- G** - Plain White with Gloss Finish
- C** - Custom Artwork with Gloss Finish - Specify Custom Artwork Number¹

Back Packaging (select one option)

- G** - Plain White with Gloss Finish²
- C** - Custom Artwork with Gloss Finish - Specify Custom Artwork Number¹
- 1** - Plain White with Gloss Finish with Magnetic Stripe²
- 3** - Custom Artwork with Gloss Finish with Magnetic Stripe - Specify Custom Artwork Number¹

Seos Card Numbering³ (select one option)

- M** - Sequential Matching Encoded/Printed (Inkjetted)⁵
- N** - No Printed Card Numbering
- S** - Sequential Encoded/Sequential Non-Matching Printed (Inkjetted)⁵
- R** - Random Encoded/Non-Matching Sequential Printed (Inkjetted)⁵
- A** - Sequential Matching Encoded/Printed (Laser Engraved)
- B** - Sequential Encoded/Sequential Non-Matching Printed (Laser Engraved)
- C** - Random Encoded/Non-Matching Sequential Printed (Laser Engraved)

Slot Punch⁴

- N** - No Slot Punch

125 kHz Card Numbering³ (select one option)

- M** - Sequential Matching Encoded/Printed (Inkjetted)⁵
- N** - No Printed Card Numbering
- S** - Sequential Encoded/Sequential Non-Matching Printed (Inkjetted)⁵
- R** - Random Encoded/Non-Matching Sequential Printed (Inkjetted)⁵
- A** - Sequential Matching Encoded/Printed (Laser Engraved)
- B** - Sequential Encoded/Sequential Non-Matching Printed (Laser Engraved)
- C** - Random Encoded/Non-Matching Sequential Printed (Laser Engraved)

Option - Custom Artwork¹

- _____ (Specify Artwork Number - Refer to the Custom Artwork Forms for new artwork)

Enter your final card options from check boxes above. Example: 5105PGNNN

Final Part Number	510						N		-	(Options #)
-------------------	-----	--	--	--	--	--	---	--	---	-------------

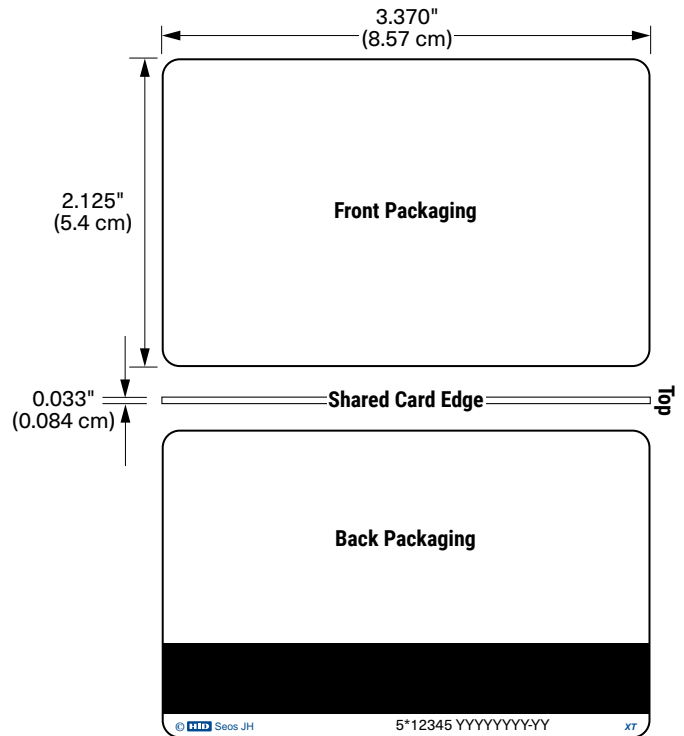

Y = Seos Programming
12345 = Card ID Number
YYYYYYY-YY = Sales Order Number



Seos Card Programming Information

Format Number	Field Name(s) e.g. Facility Code	Value	QTY	Encoded Start Number	Encoded Stop Number
HID Elite ICE number				Printed Start Number	Printed Stop Number

125 kHz Card Programming Information

Format Number	Field Name(s) e.g. Facility Code	Value	QTY	Encoded Start Number	Encoded Stop Number
				Printed Start Number	Printed Stop Number

¹ For new artwork files, contact Customer Service for custom artwork number, lead-times, and cost.

² Cards ordered with plain white front and back packaging, or custom artwork, will still have a small HID logo  and reference number printed in the lower left-hand corner. Most part numbers are marked with the sales order number. A custom part number is required to omit all marking from the card. Contact your local support representative for details.

³ The Printed card number is placed in the bottom right-hand corner on the back of the card.

⁴ Cards are not available with any slot punch option.

⁵ Please note that cards shipped within the Americas are always laser-engraved. Inkjetted option is not available for these cards.

⁶ Available with 7 byte static UID for ISO14443A UID migration and interoperability. This feature reduces privacy and is not recommended. Contact your local sales or pre-sales representative for details.

* The composite construction is recommended for all cards with over-laminate applied. Consult with the printer manufacturer prior to ordering.

Seos + iCLASS + Prox Card - 520

Migration solution from proximity and/or iCLASS to high security for support in HID Signo or iCLASS SE reader platform.

Ensure each required option has been checked with the appropriate choice to fulfill a completed order form.

Base Model **520 Composite 40% Polyester / PVC***

Seos Memory Size and Allocation

6 - Seos 8K Bytes⁶

iCLASS Memory Size and Allocation

- 0 - iCLASS 2k Bits (256 Bytes) with 2 Application Areas**
- 3 - CLASS 32k Bits (4K Bytes) Application areas 16k/2+16k/1**
- 4 - CLASS 32k Bits (4K Bytes) Application areas 16k/16+16k/1**

Seos Programming (select one option)

- P - Programmed with Security Identity Object (SIO)**
- V - Unprogrammed, for use with iCLASS SE Encoder**

iCLASS Programming (select one option)

- S - Programmed with Security Identity Object (SIO) and with standard iCLASS Access Control Application (recommended)**
- P - Programmed with Security Identity Object (SIO)**
- H - Programmed with standard iCLASS Access Control Application**
- C - Unprogrammed, for use with iCLASS SE Encoder**

125 kHz Programming (select one option)

- P - Programmed with HID or Indala format**
- N - HID Prox unprogrammed for use with iCLASS SE Encoder**

Front Packaging (select one option)

- G - Plain White with Gloss Finish**
- C - Custom Artwork with Gloss Finish - Specify Custom Artwork Number¹**

Back Packaging (select one option)

- G - Plain White with Gloss Finish²**
- C - Custom Artwork with Gloss Finish - Specify Custom Artwork Number¹**
- 1 - Plain White with Gloss Finish with Magnetic Stripe²**
- 3 - Custom Artwork with Gloss Finish with Magnetic Stripe - Specify Custom Artwork Number¹**

Seos Card Numbering³ (select one option)

- N - No Printed Card Numbering**
- A - Sequential Matching Encoded/Printed (Laser Engraved)⁴**
- B - Sequential Encoded/Sequential Non-Matching Printed (Laser Engraved)⁴**
- C - Random Encoded/Non-Matching Sequential Printed (Laser Engraved)⁴**

iCLASS Card Numbering³ (select one option)

- N - No Printed Card Numbering**
- A - Sequential Matching Encoded/Printed (Laser Engraved)⁴**
- B - Sequential Encoded/Sequential Non-Matching Printed (Laser Engraved)⁴**
- C - Random Encoded/Non-Matching Sequential Printed (Laser Engraved)⁴**

Prox Card Numbering³ (select one option)

- N - No Printed Card Numbering**
- A - Sequential Matching Encoded/Printed (Laser Engraved)⁴**
- B - Sequential Encoded/Sequential Non-Matching Printed (Laser Engraved)⁴**
- C - Random Encoded/Non-Matching Sequential Printed (Laser Engraved)⁴**

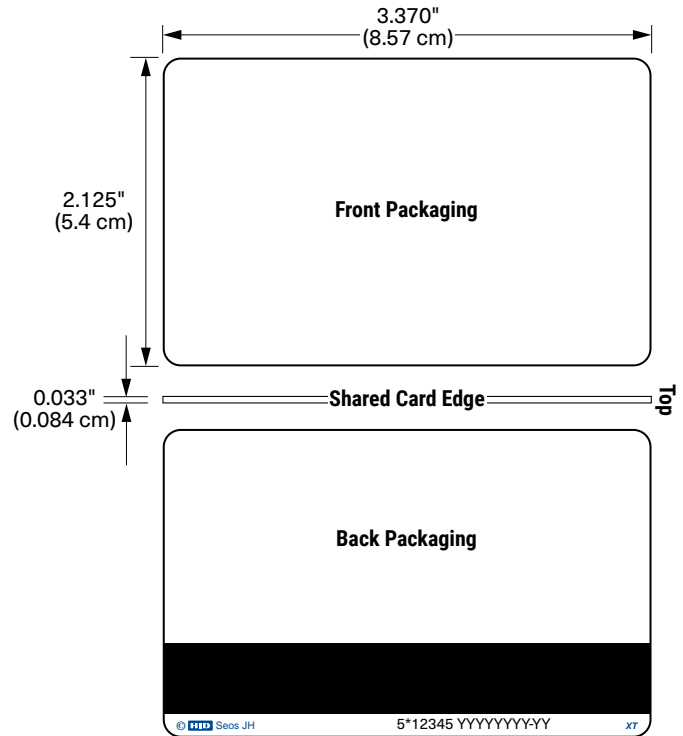

Y = Seos Programming
12345 = Card ID Number
YYYYYYY-YY = Sales Order Number



Slot Punch⁵

N - No Slot Punch

Option - Custom Artwork¹

_____ (Specify Artwork Number - Refer to the Custom Artwork Forms for new artwork)

Enter your final card options from check boxes above. Example: 52063PSPGGAAAN

Final Part Number	520	6										N	-	(Options #)
-------------------	-----	---	--	--	--	--	--	--	--	--	--	---	---	-------------

Seos Card Programming Information

Format Number	Field Name(s) e.g. Facility Code	Value	QTY	Encoded Start Number	Encoded Stop Number
HID Elite ICE number				Printed Start Number	Printed Stop Number

iCLASS Card Programming Information

Format Number	Field Name(s) e.g. Facility Code	Value	QTY	Encoded Start Number	Encoded Stop Number
HID Elite ICE number				Printed Start Number	Printed Stop Number

125 kHz Card Programming Information

Format Number	Field Name(s) e.g. Facility Code	Value	QTY	Encoded Start Number	Encoded Stop Number
				Printed Start Number	Printed Stop Number

¹ For new artwork files, contact Customer Service for custom artwork number, lead-times, and cost.

² Cards ordered with plain white front and back packaging, or custom artwork, will still have a small HID logo and reference number printed in the lower left-hand corner and a slot punch target printed on the back of the card. Most part numbers are marked with sales order number. A custom part number is required to omit all marking from the card. Contact your local support representative for details.

³ The Printed card number is placed in the bottom right-hand corner on the back of the card.

⁴ Inkjetted option is not available for these cards.

⁵ Cards are not available with any slot punch option.

⁶ Available with 7 byte static UID for ISO14443A UID migration and interoperability. This feature reduces privacy and is not recommended. Contact your local sales or pre-sales representative for details.

* The composite construction is recommended for all cards with over-laminate applied. Consult with the printer manufacturer prior to ordering.

Seos 8K with MIFARE Classic or DESFire EV1 Implementation – 5806/5906

Migration solution from MIFARE Classic 4K or MIFARE DESFire EV1 to Seos 8K in HID Signo or iCLASS SE reader platform.

Base Model 5806 Composite 40% Polyester / PVC* Seos 8K with MIFARE Classic 4K Implementation
Base Model 5906 Composite 40% Polyester / PVC* Seos 8K with MIFARE DESFire EV1 8K Implementation

This product requires additional qualification and test activities, please refer to [PLT-04003](#) for full technical details, product compatibility, part numbers and order process.

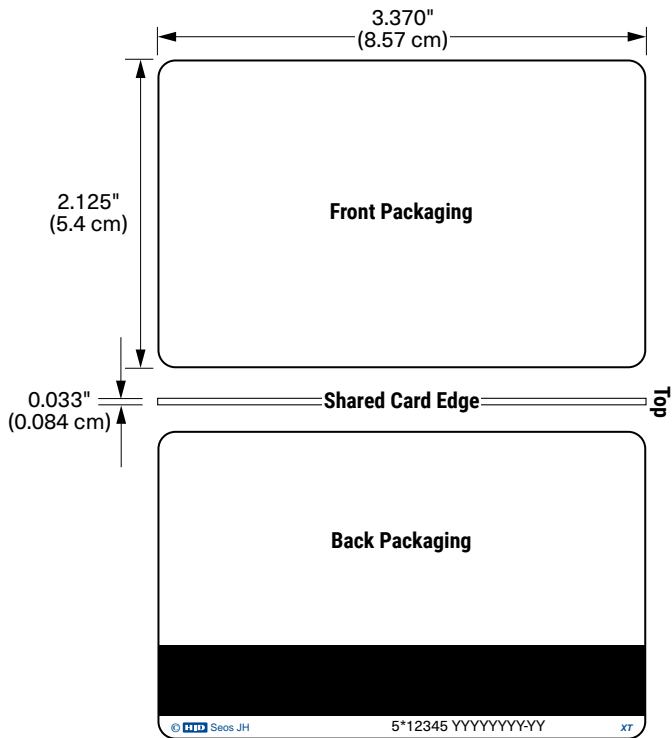

Y = Seos Programming
 12345 = Card ID Number
 YYYYYYYY-YY = Sales Order Number

Seos Key Fob - 526

Portable Credential for Key Ring Applications.

Designed for HID Signo and single technology iCLASS SE and iCLASS SE Express Readers.

- This product is not compatible with the multiCLASS SE reader family.
- Please ensure that this page is completed and submitted alongside your first order to activate part numbers.
- Allow 1-2 days for part activation.
- See datasheet for compatibility and performance details.

I have read the datasheet and understand that this product is not compatible with the multiCLASS SE reader family.

Name	
Company	

Ensure each required option has been checked with the appropriate choice to fulfill a completed order form.

Base Model 526

Memory Size

6- 8K Bytes

Secure Identity Object Programming (select one option)

- P - Programmed with Secure Identity Object (SIO)
 V - Unprogrammed, for use with iCLASS SE Encoder

Front Packaging

N - Black ABS body, grey TPE insert with HID logo

Back Packaging

N - Seos logo and marking panel

Key Numbering¹

- N - No external ID number
 A - Sequential Matching Encoded/Printed (Engraved)
 B - Sequential Encoded/Sequential Non-Matching Printed (Engraved)
 C - Random Encoded/Non-Matching Sequential Printed (Engraved)

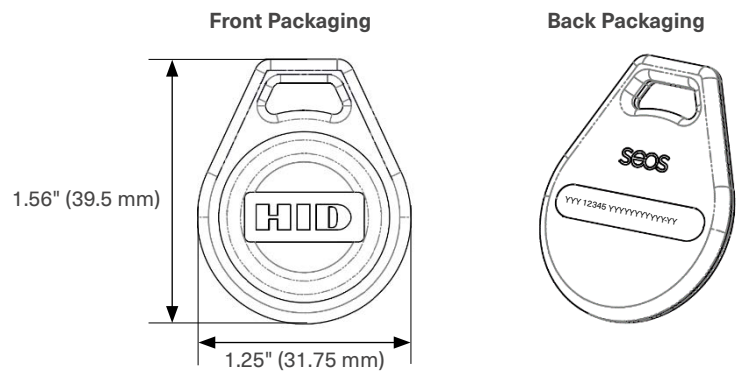

Y = Seos Programming
 12345 = Card ID Number
 YYYYYYYYYY = Sales Order Number

Enter your final options from the above selections. Example: 5266PNNA

Final Part Number	5266		N	N	
--------------------------	------	--	---	---	--

Seos Programming Information

Format Number	Field Name(s) e.g. Facility Code	Value	QTY	Encoded Start Number	Encoded Stop Number
HID Elite ICE number				Printed Start Number	Printed Stop Number

¹ The ID number is marked on the back of the key fob. All options include a printed sales order number.

² Available with 7 byte static UID for ISO14443A UID migration and interoperability. This feature reduces privacy and is not recommended. Contact your local sales or pre-sales representative for more information.

Seos Clamshell - 565

Highly Durable Slot Punched Contactless Smart Card.

Ensure each required option has been checked with the appropriate choice to fulfill a completed order form.

Base Model **565**

Memory Size

6 - 8K Bytes

Secure Identity Object Programming (select one option)

- P** - Programmed with Secure Identity Object (SIO)
- V** - Unprogrammed, for use with iCLASS SE Encoder

Front Packaging

- M** - Plain White Matte Vinyl with Seos logo
- C** - Custom Artwork – Specify Custom Artwork Number¹

Back Packaging

- S** - ABS Base with Molded HID Logo
- C** - Custom Artwork – Specify Custom Artwork Number¹

Key Numbering²

- N** - No external ID number
- A** - Sequential Matching Encoded/Printed (Engraved)
- B** - Sequential Encoded/Sequential Non-Matching Printed (Engraved)
- C** - Random Encoded/Non-Matching Sequential Printed (Engraved)

Slot Punch

V - Vertical Slot Punch

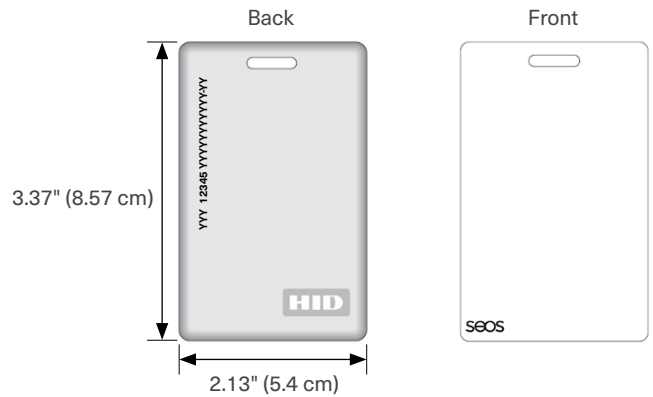

Enter your final options from the above selections. Example: 5656PMSAV

Final Part Number	5656					V
-------------------	------	--	--	--	--	---

Seos Programming Information

Format Number	Field Name(s) e.g. Facility Code	Value	QTY	Encoded Start Number	Encoded Stop Number
HID Elite ICE number				Printed Start Number	Printed Stop Number

¹ For new artwork files, contact Customer Service for custom artwork number, lead-times, and cost.

² The ID number is marked on the back of the clamshell. All options include a printed sales order number.

Available with 7 byte static UID for ISO14443A UID migration and interoperability. This feature reduces privacy and is not recommended. Contact your local sales or pre-sales representative for more information.

Seos Essential Card - 550

A simple high security single application card for physical access control applications, supported by HID Signo and iCLASS SE reader platforms.¹

Ensure each required option has been checked with the appropriate choice to fulfill a completed order form.

Base Model **550 Composite (40% polyester/PVC)**

Secure Identity Object™ programming²

P - Programmed with Secure Identity Object (SIO)

Front packaging

G - Plain white with gloss finish

Back packaging³

G - Plain white with gloss finish

Card numbering⁴ (select one option)

- N** - No printed card numbering, sales number marking only
- A** - Sequential matching encoded/printed (laser engraved)
- B** - Sequential encoded/sequential non-matching printed (laser engraved)
- C** - Random encoded/non-matching sequential printed (laser engraved)

Slot punch

N - No Slot Punch

IMPORTANT: 550 credentials do not allow a slot punch due to antenna design. Use a badge holder to attach this card to a lanyard or badge clip.

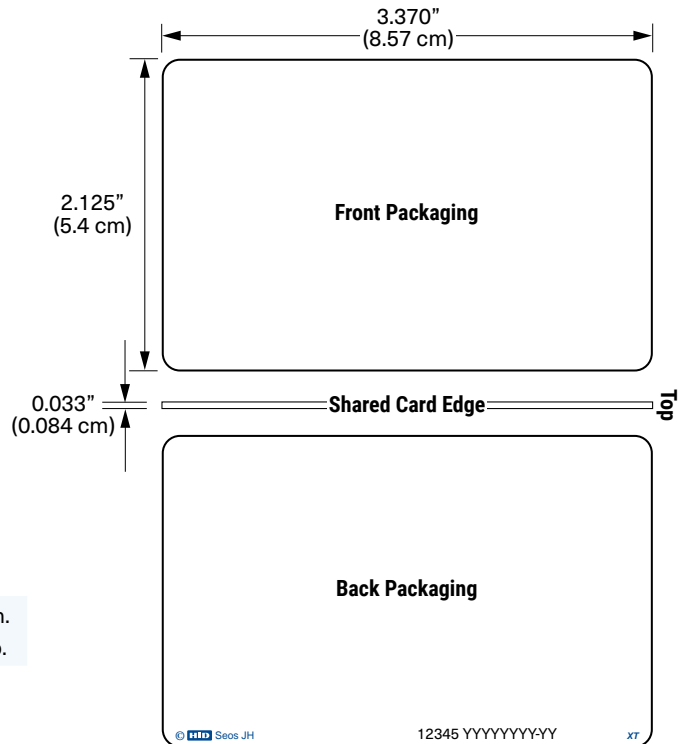

12345 = Card ID Number
YYYYYYYY-YY = Sales Order Number

Enter your final card options from check boxes above. For example, 550PGGAN

Final Part Number	550	P	G	G		N
-------------------	-----	---	---	---	--	---

Seos Programming Information

Format Number	Field Name(s) e.g. Facility Code	Value	QTY	Encoded Start Number	Encoded Stop Number
HID Elite ICE #				Printed Start Number	Printed Stop Number

¹ Seos Essential has limited availability in North America, please contact your local sales representativity for more information.

² This card does not support additional applications. The credential is programmed with a single SIO physical access control application and additional applications cannot be added.

³ A small HID logo and reference number is printed in the lower left-hand corner on the back of the card. All cards are marked with the sales order number regardless of the card numbering option.

⁴ The printed card number is placed in the bottom right-hand corner on the back of the card.

Seos Essential + Prox Card - 551

Migration solution from proximity to high security for simple physical access control applications, supported by HID Signo and iCLASS SE reader platforms.¹

Ensure each required option has been checked with the appropriate choice to fulfill a completed order form.

Base Model **551 Composite (40% polyester/PVC)**

Secure Identity Object™ programming²

P - Programmed with Secure Identity Object (SIO)

125kHz programming (select one option)

- P** - Programmed with HID or Indala® format
- N** - HID Prox® unprogrammed for use with iCLASS SE Encoder

Front packaging

G - Plain white with gloss finish

Back packaging³

G - Plain white with gloss finish

Seos card numbering⁴ (select one option)

- N** - No printed card numbering, sales number marking only
- A** - Sequential matching encoded/printed (laser engraved)
- B** - Sequential encoded/sequential non-matching printed (laser engraved)
- C** - Random encoded/non-matching sequential printed (laser engraved)

Slot punch

N - No Slot Punch

IMPORTANT: 551 credentials do not allow a slot punch due to antenna design. Use a badge holder to attach this card to a lanyard or badge clip.

125kHz card numbering⁴ (select one option)

- N** - No printed card numbering, sales number marking only
- A** - Sequential matching encoded/printed (laser engraved)
- B** - Sequential encoded/sequential non-matching printed (laser engraved)
- C** - Random encoded/non-matching sequential printed (laser engraved)

Enter your final card options from check boxes above. For example, 551PPGGANA

Final Part Number	551	P		G	G		N	
-------------------	-----	---	--	---	---	--	---	--

Seos Programming Information

Format Number	Field Name(s) e.g. Facility Code	Value	QTY	Encoded Start Number	Encoded Stop Number
HID Elite ICE #				Printed Start Number	Printed Stop Number

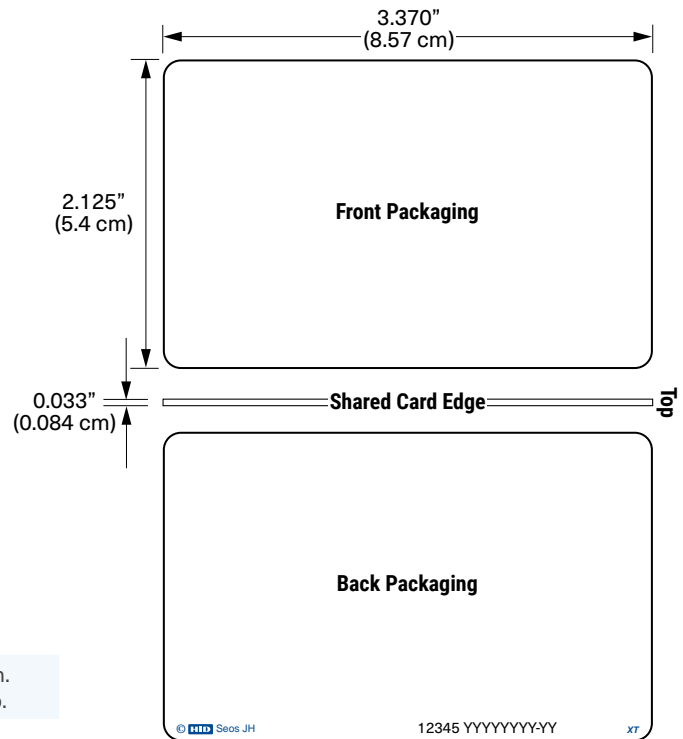

12345 = Card ID Number
YYYYYYYY-YY = Sales Order Number



125kHz card Programming Information

Format Number	Field Name(s) e.g. Facility Code	Value	QTY	Encoded Start Number	Encoded Stop Number
				Printed Start Number	Printed Stop Number

¹ Seos Essential has limited availability in North America, please contact your local sales representativity for more information.

² This card does not support additional applications. The credential is programmed with a single SIO physical access control application and additional applications cannot be added.

³ A small HID logo and reference number is printed in the lower left-hand corner on the back of the card. All cards are marked with the sales order number regardless of the card numbering option.

⁴ The printed card number is placed in the bottom right-hand corner on the back of the card.



iCLASS Card Programming Information

Format #	Field Name(s) e.g. Facility Code	Value	QTY	Encoded Start Number	Encoded Stop Number
HID Elite ICE number				Printed Start Number	Printed Stop Number

¹ For new artwork files, contact Customer Service for custom artwork number, lead-times, and cost.

² Cards ordered with plain white front and back packaging, or custom artwork, will still have a small HID logo  and reference number printed in the lower left-hand corner and a slot punch target printed on the back of the card. Most part numbers are marked with the sales order number. A custom part number is required to omit all marking from the card. Contact your local support representative for details.

³ The Printed card number is placed in the bottom right-hand corner on the back of the card.

⁴ For Laser Engraved Printed numbers, contact customer service for lead times and cost.

⁵ Cards are provided with an optional slot punch at no additional charge. Some video imaging printers cannot accommodate pre-slot punched cards.

⁶ The ability to add a horizontal slot punch requires a different iCLASS antenna design. Users can expect a read range reduction of approximately 20% if they order options B or H for the Slot Punch.

⁷ Please note that cards shipped within the Americas are always laser-engraved. Inkjetted option is not available for these cards.

* The composite construction is recommended for all cards with over-laminate applied. Consult with the printer manufacturer prior to ordering.

iCLASS SE + Prox Card - 315

Maximized compatibility with added security into installations that contain standard Prox credentials. These cards are not available with iCLASS programming, a composite fee applies to this card.

Ensure each required option has been checked with the appropriate choice to fulfill a completed order form.

Base Model **315 Composite 40% Polyester / PVC***

iCLASS Memory Size and Allocation (select one option)

- 0** - 2k Bits (256 Bytes) with 2 Application Areas
- 3** - 32k Bits (4K Bytes) Application areas 16k/2+16k/1
- 4** - 32k Bits (4K Bytes) Application areas 16k/16+16k/1

Secure Identity Object Programming (select one option)

- P** - Programmed with Security Identity Object (SIO), 125 kHz HID Prox unprogrammed
- R** - Both interfaces programmed: iCLASS with Security Identity Object (SIO), 125 kHz programmed with HID or Indala format

Front Packaging (select one option)

- G** - Plain White with Gloss Finish
- C** - Custom Artwork with Gloss Finish - Specify Custom Artwork Number¹

Back Packaging (select one option)

- G** - Plain White with Gloss Finish²
- C** - Custom Artwork with Gloss Finish - Specify Custom Artwork Number¹
- 1** - Plain White with Gloss Finish with Magnetic Stripe²
- 3** - Custom Artwork with Gloss Finish with Magnetic Stripe - Specify Custom Artwork Number¹

13.56 MHz iCLASS Card Numbering³ (select one option)

- M** - Sequential Matching Encoded/Printed (Inkjetted)⁵
- N** - No Printed Card Numbering
- S** - Sequential Encoded/Sequential Non-Matching Printed (Inkjetted)⁵
- R** - Random Encoded/Non-Matching Sequential Printed (Inkjetted)⁵
- A** - Sequential Matching Encoded/Printed (Laser Engraved)
- B** - Sequential Encoded/Sequential Non-Matching Printed (Laser Engraved)⁴
- C** - Random Encoded/Non-Matching Sequential Printed (Laser Engraved)

Slot Punch⁴ (select one option)

- N** - No Slot Punch. This card can be slotted vertically, Printed Vertical Slot Indicators
- V** - Vertical Slot Punch

125 kHz Card Numbering³ (select one option)

- M** - Sequential Matching Encoded/Printed (Inkjetted)⁵
- N** - No Printed Card Numbering
- S** - Sequential Encoded/Sequential Non-Matching Printed (Inkjetted)⁵
- R** - Random Encoded/Non-Matching Sequential Printed (Inkjetted)⁵
- A** - Sequential Matching Encoded/Printed (Laser Engraved)
- B** - Sequential Encoded/Sequential Non-Matching Printed (Laser Engraved)
- C** - Random Encoded/Non-Matching Sequential Printed (Laser Engraved)

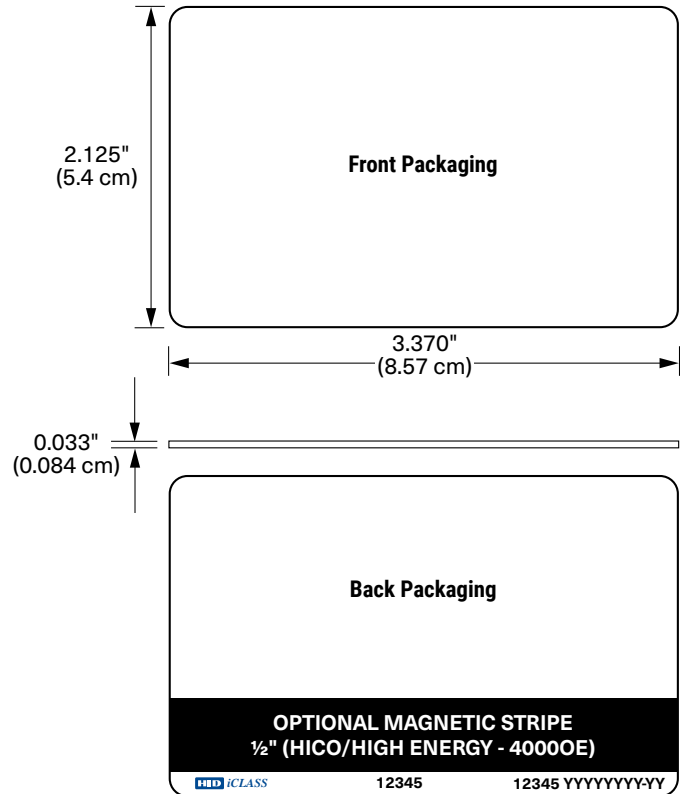

Y = iCLASS Programming
12345 = Card ID Number
YYYYYYYY-YY = Sales Order Number



Option - Custom Artwork¹

_____ (Specify Artwork Number - Refer to the Custom Artwork Forms for new artwork)

Enter your final card options from check boxes above. Example: 3150PGNNN

Final Part Number								-		(Options #)
-------------------	--	--	--	--	--	--	--	---	--	-------------

iCLASS Card Programming Information

Format Number	Field Name(s) e.g. Facility Code	Value	QTY	Encoded Start Number	Encoded Stop Number
HID Elite ICE number				Printed Start Number	Printed Stop Number

125 kHz Card Programming Information

Format Number	Field Name(s) e.g. Facility Code	Value	QTY	Encoded Start Number	Encoded Stop Number
				Printed Start Number	Printed Stop Number

- ¹ For new artwork files, contact Customer Service for custom artwork number, lead-times, and cost.
- ² Cards ordered with plain white front and back packaging, or custom artwork, will still have a small HID logo and reference number printed in the lower left-hand corner and a slot punch target printed on the back of the card. Most part numbers are marked with the sales order number. A custom part number is required to omit all marking from the card. Contact your local support representative for details.
- ³ The Printed card number is placed in the bottom right-hand corner on the back of the card.
- ⁴ Cards are provided with an optional slot punch at no additional charge. Some video imaging printers cannot accommodate pre-slot punched cards.
- ⁵ Please note that cards shipped within the Americas are always laser-engraved. Inkjetted option is not available for these cards.

iCLASS SE Key - 325

The iCLASS SE contactless smart Key offers read/write capability while leveraging Security Identity Object for increased security. Attach to a key ring or badge clip for convenient use. The iCLASS SE key is not available with iCLASS programming.

Ensure each required option has been checked with the appropriate choice to fulfill a completed order form.

325 Base Model

iCLASS Memory Size and Allocation (select one option)

- 0** - 2k Bits (256 Bytes) with 2 Application Areas
- 3** - 32k Bits (4K Bytes) Application areas 16k/2+16k/1
- 4** - 32k Bits (4K Bytes) Application areas 16k/16+16k/1

Secure Identity Object Programming (select one option)

- P** - Programmed with Security identity Object (SIO)
- V** - Unprogrammed, for use with iCLASS SE Encoder

Front Packaging

- N** - iCLASS Key II - Black with blue insert. Includes HID Standard Artwork

Back Packaging

- N** - None

Key Numbering

- M** - Sequential Matching Encoded/Printed (Inkjetted)⁴
- N** - No Printed Key Numbering
- S** - Sequential Encoded/Sequential Non-Matching Printed (Inkjetted)⁴
- R** - Random Encoded/Non-Matching Sequential Printed (Inkjetted)⁴
- A** - Sequential Matching Encoded/Printed (Engraved)
- B** - Sequential Encoded/Sequential Non-Matching Printed (Engraved)
- C** - Random Encoded/Non-Matching Sequential Printed (Engraved)

Additional Options³

- N** - None

Enter your final card options from the above selections. Example: 3250PNNMN

Final Part Number	325			N	N		N
-------------------	-----	--	--	---	---	--	---

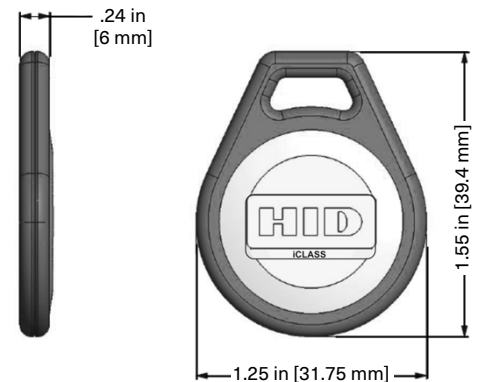

Shown - Front Packaging Option N

iCLASS Key Programming Information

Format Number	Field Name(s) e.g. Facility Code	Value	QTY	Encoded Start Number	Encoded Stop Number
HID Elite ICE Number				Printed Start Number	Printed Stop Number

¹ The Printed key number is placed on the back of the key.

² Key Ring sold separately (Part Number: 57-0001-02).

⁴ Please note that cards shipped within the Americas are always laser-engraved. Inkjetted option is not available for these cards.

iCLASS SE Tag - 330

The iCLASS SE contactless smart Tag offers read/write capability while leveraging Security Identity Object for increased security. iCLASS SE enable existing credentials or non-metallic devices such as cell phones or PDAs by adhering the iCLASS Tag. The iCLASS SE Tag is not available with iCLASS programming.

Ensure each required option has been checked with the appropriate choice to fulfill a completed order form.

330 Base Model

iCLASS Memory Size and Allocation (select one option)

- 0** - 2k Bits (256 Bytes) with 2 Application Areas
- 3** - 32k Bits (4K Bytes) Application areas 16k/2+16k/1
- 4** - 32k Bits (4K Bytes) Application areas 16k/16+16k/1

Secure Identity Object Programming (select one option)

- P** - Programmed with Secure Identity Object (SIO).
- V** - Unprogrammed, for use with iCLASS SE Encoder

Front Packaging (select one option)

- K** - Black with HID Standard Artwork
- C** - Custom Artwork - Specify Custom Artwork Number²

Back Packaging

- S** - Adhesive Backing

Tag Numbering1(select one option)

- M** - Sequential Matching Encoded/Printed (Inkjetted)⁴
- N** - No Printed Tag Numbering
- S** - Sequential Encoded/Sequential Non-Matching Printed (Inkjetted)⁴
- R** - Random Encoded/Non-Matching Sequential Printed (Inkjetted)⁴

Slot Punch

- N** - None

Option - Custom Artwork¹

_____ (Specify Artwork Number - Refer to the Custom Artwork Forms for new artwork)

Enter your final Tag options from check boxes above. Example: 3302PSSNN

Final Part Number	330				S		N	-	(Options #)
-------------------	-----	--	--	--	---	--	---	---	-------------

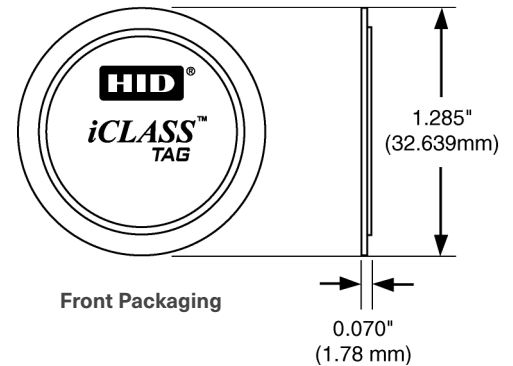

iCLASS Tag Programming Information

Format Number	Field Name(s) e.g. Facility Code	Value	QTY	Encoded Start Number	Encoded Stop Number
HID Elite ICE #				Printed Start Number	Printed Stop Number

¹ The Printed tag number is placed on the back of the tag. In order to support laser marking technology HID will be transitioning from a white release paper to a black release paper. Please consult your sales Account Manager for more information.

² For new artwork files, contact Customer Service for custom artwork number, lead-times, minimum order quantities, and cost.

³ The iCLASS Tag is not for use on cards that use full insertion or tractor feed type readers.

⁴ Please note that cards shipped within the Americas are always laser-engraved. Inkjetted option is not available for these cards.

Do not adhere to metal surfaces. Metal shields the RF, making the tag inoperable. Due to variations in cards and reading devices, HID does not claim that the iCLASS Tag will work in every situation. Functional and non-functional iCLASS Tags are available for compatibility testing with existing credential and reader technologies. Compatibility should be confirmed prior to ordering.

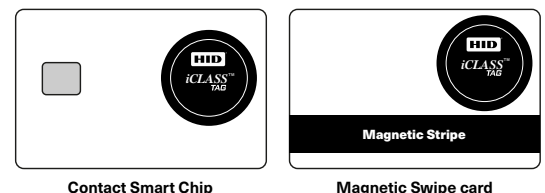

iCLASS SE Clamshell Card - 335

Added security into installations that do not contain standard iCLASS readers, these cards are not available with iCLASS programming.

Ensure each required option has been checked with the appropriate choice to fulfill a completed order form.

335 Base Model

iCLASS Memory Size and Allocation (select one option)

0 - 2k Bits (256 Bytes) with 2 Application Areas

Secure Identity Object Programming (select one option)

- P** - Programmed with Security Identity Object (SIO)
- V** - Unprogrammed, for use with iCLASS SE Encoder

Front Packaging (select one option)

- M** - Plain White Vinyl with Matte Finish
- G** - Plain White with Gloss Finish
- C** - Custom Artwork - Specify Custom Artwork Number¹

Back Packaging (select one option)

- S** - Base with Molded HID Logo
- C** - Custom Artwork - Specify Custom Artwork Number¹

Card Numbering² (select one option)

- M** - Sequential Matching Encoded/Printed (Inkjetted)⁴
- N** - No Printed Card Numbering
- S** - Sequential Encoded/Sequential Non-Matching Printed (Inkjetted)³
- R** - Random Encoded/Non-Matching Sequential Printed (Inkjetted)³

Slot Punch

V - Vertical Slot Punch

Option - Custom Artwork²

_____ (Specify Artwork Number - Refer to the Custom Artwork Forms for new Artwork)

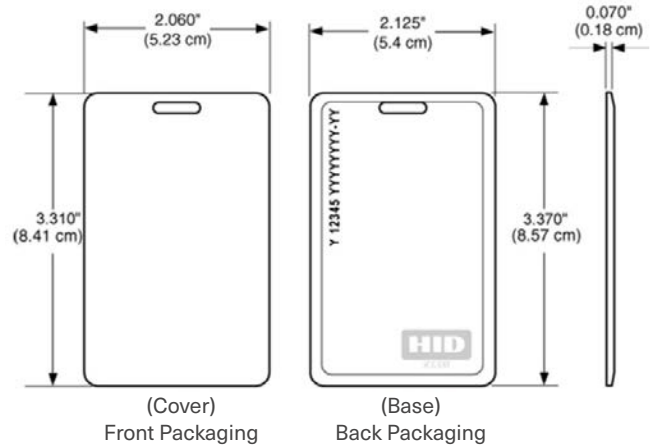

Y = iCLASS Programming
12345 = Card ID Number
YYYYYYYY-YY = Sales Order Number

Enter your final card options from check boxes above. Example: 3350PMSMV

Final Part Number	335						V	-	(Options #)
-------------------	-----	--	--	--	--	--	---	---	-------------

iCLASS Card Programming Information

Format Number	Field Name(s) e.g. Facility Code	Value	QTY	Encoded Start Number	Encoded Stop Number
HID Elite ICE #				Printed Start Number	Printed Stop Number

¹ For new artwork files, contact Customer Service for custom artwork number, lead-times, and cost.

² The Printed card number is placed in the top left-hand corner on the back of the card. The HID logo is molded into the base on back of the card. Most part numbers are marked with the sales order number. A custom part number is required to omit all marking from the card. Contact your local support representative for details.

³ Please note that cards shipped within the Americas are always laser-engraved. Inkjetted option is not available for these cards.

iCLASS SE + MIFARE Classic - 391

The SIO-Enabled iCLASS with MIFARE Classic contactless smart card offers multiple High Frequency technologies to simplify card issuance for diverse systems or migration projects. This card offers maximized compatibility installations that contain iCLASS SE or MIFARE Classic.

Ensure each required option has been checked with the appropriate choice to fulfill a completed order form.

Base Model **391 Composite 40% Polyester / PVC***

iCLASS Memory Size and Allocation (select one option)

- 0** - 2k Bits (256 Bytes) with 2 Application Areas
(only available with MIFARE Classic 1K)
- 3** - 32k Bits (4K Bytes) Application areas 16k/2+16k/1
- 4** - 32k Bits (4K Bytes) Application areas 16k/16+16k/1

Card Programming (select one option)

- R** - iCLASS programmed with Secure Identity Object (SIO), MIFARE Classic programmed with Secure Identity Object (SIO)
- P** - iCLASS programmed with Secure Identity Object (SIO), MIFARE Classic unprogrammed for use with iCLASS SE encoder (HID MIFARE or custom encoding)
- K** - iCLASS programmed with Secure Identity Object (SIO), MIFARE Classic programmed with HID MIFARE Classic or custom MIFARE Classic (option M or N 2nd HF only).
- A** - iCLASS unprogrammed for use with iCLASS SE Encoder, MIFARE Classic programmed with Secure Identity Object (SIO)
- B** - iCLASS unprogrammed for use with iCLASS SE Encoder, MIFARE Classic unprogrammed for use with iCLASS SE encoder (HID MIFARE or custom encoding)
- V** - iCLASS unprogrammed for use with iCLASS SE Encoder, MIFARE Classic unprogrammed for use with iCLASS SE encoder (SIO, HID MIFARE or custom encoding)

MIFARE Classic (select one option)

- M** - MIFARE Classic 1K Bytes (only available with iCLASS 2k bits)
- N** - MIFARE Classic 4K Bytes

Front Packaging (select one option)

- G** - Plain White with Gloss Finish
- C** - Custom Artwork with Gloss Finish - Specify Custom Artwork Number¹

Back Packaging (select one option)

- G** - Plain White with Gloss Finish²
- C** - Custom Artwork with Gloss Finish - Specify Custom Artwork Number¹
- 1** - Plain White with Gloss Finish with Magnetic Stripe²
- 3** - Custom Artwork with Gloss Finish with Magnetic Stripe - Specify Custom Artwork Number¹

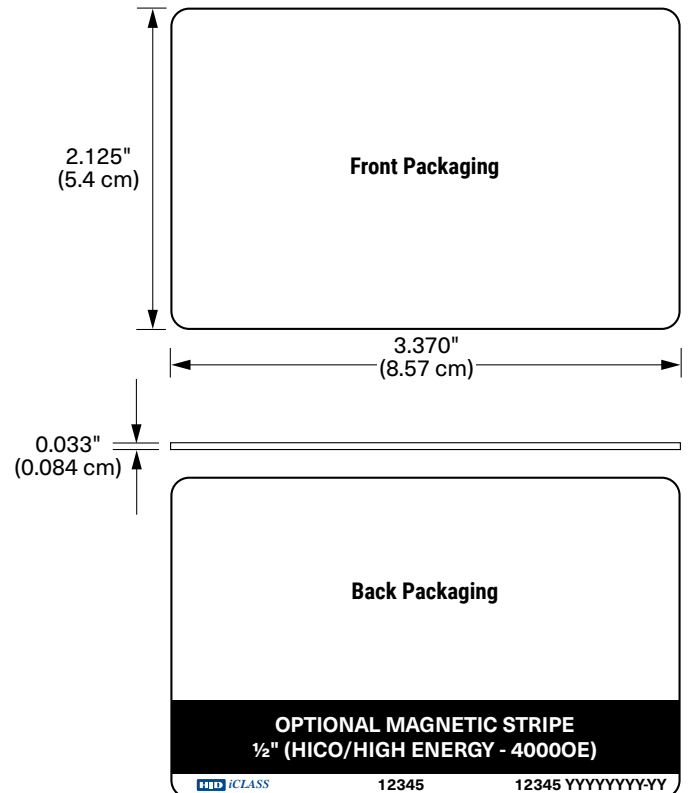

12345 = Card ID Number
YYYYYYY-YY = Sales Order Number



iCLASS SE Card Numbering³ (select one option)

- M** - Sequential Matching Encoded/Printed (Inkjetted)⁶
- N** - No Printed Card Numbering
- S** - Sequential Encoded/Sequential Non-Matching Printed (Inkjetted)⁵
- R** - Random Encoded/Non-Matching Sequential Printed (Inkjetted)⁵
- A** - Sequential Matching Encoded/Printed (Laser Engraved)
- B** - Sequential Encoded/Sequential Non-Matching Printed (Laser Engraved)
- C** - Random Encoded/Non-Matching Sequential Printed (Laser Engraved)

Slot Punch

IMPORTANT: Dual High Frequency credentials do not allow a slot punch due to the antenna design. HID recommends using a badge holder to attach this card to a lanyard or badge clip.

- N** - No Slot Punch

MIFARE Classic Card Numbering³ (select one option)

- M** - Sequential Matching Encoded/Printed (Inkjetted)⁵
- N** - No Printed Card Numbering
- S** - Sequential Encoded/Sequential Non-Matching Printed (Inkjetted)⁵
- R** - Random Encoded/Non-Matching Sequential Printed (Inkjetted)⁵
- A** - Sequential Matching Encoded/Printed (Laser Engraved)
- B** - Sequential Encoded/Sequential Non-Matching Printed (Laser Engraved)
- C** - Random Encoded/Non-Matching Sequential Printed (Laser Engraved)

Option - Custom Artwork¹

_____ (Specify Artwork Number - Refer to the Custom Artwork Forms for new artwork)

Enter your final card options from the above selections. Example: 3914RNGCMNM

Final Part Number						N		-	(Options #)
-------------------	--	--	--	--	--	---	--	---	-------------

iCLASS SE Card Programming Information

Format Number	Field Name(s) e.g. Facility Code	Value	QTY	Encoded Start Number	Encoded Stop Number
HID Elite ICE #				Printed Start Number	Printed Stop Number

MIFARE Classic Card Programming Information

Format Number	Field Name(s) e.g. Facility Code	Value	QTY	Encoded Start Number	Encoded Stop Number
HID Elite ICE #				Printed Start Number	Printed Stop Number

¹ For new artwork files, contact Customer Service for custom artwork number, lead-times, and cost.

² Cards ordered with plain white front and back packaging, or custom artwork, will still have a small HID logo and reference number printed in the lower left-hand corner and a slot punch target printed on the back of the card. Most part numbers are marked with the sales order number. A custom part number is required to omit all marking from the card. Contact your local support representative for details.

⁵ Please note that cards shipped within the Americas are always laser-engraved. Inkjetted option is not available for these cards.

* The composite construction is recommended for all cards with over-laminate applied. Consult with the printer manufacturer prior to ordering.

iCLASS SE + MIFARE Classic + Prox Card - 396

The SIO-enabled card with MIFARE Classic or contactless smart card as well as HID Proximity offers multiple High Frequency technologies to simplify card issuance for diverse systems or migration projects. This card offers maximized compatibility into installations that contain iCLASS SE or MIFARE Classic.

Ensure each required option has been checked with the appropriate choice to fulfill a completed order form.

Base Model **396 Composite 40% Polyester / PVC***

iCLASS SE Memory Size and Allocation (select one option)

- 0** - 2k Bits (256 Bytes) with 2 Application Areas
(only available with MIFARE Classic 1K)
- 3** - 32k Bits (4K Bytes) Application areas 16k/2+16k/1
- 4** - 32k Bits (4K Bytes) Application areas 16k/16+16k/1

13.56 MHz Technology Card Programming (select one option)

- R** - iCLASS programmed with Secure Identity Object (SIO), MIFARE Classic programmed with Secure Identity Object (SIO)
- P** - CLASS programmed with Secure Identity Object (SIO), MIFARE Classic unprogrammed for Use with iCLASS SE encoder (HID MIFARE or custom encoding)
- A** - iCLASS unprogrammed for use with iCLASS SE Encoder, MIFARE Classic programmed with Secure Identity Object (SIO)
- V** - iCLASS unprogrammed for use with iCLASS SE Encoder, MIFARE Classic unprogrammed for use with iCLASS SE encoder (SIO, HID MIFARE or custom encoding)

MIFARE Classic (select one option)

- M** - MIFARE Classic 1K Bytes (only available with iCLASS 2k bits)
- N** - MIFARE Classic 4K Bytes

125 kHz Technology Card Programming (select one option)

- P** - Programmed with HID Prox or Indala format.
- C** - Programmed with CASI Prox.
- N** - Unprogrammed HID Prox.

Front Packaging (select one option)

- G** - Plain White with Gloss Finish
- C** - Custom Artwork with Gloss Finish - Specify Custom Artwork Number¹

Back Packaging (select one option)

- G** - Plain White with Gloss Finish²
- C** - Custom Artwork with Gloss Finish - Specify Custom Artwork Number¹
- 1** - Plain White with Gloss Finish with Magnetic Stripe²
- 3** - Custom Artwork with Gloss Finish with Magnetic Stripe - Specify Custom Artwork Number¹

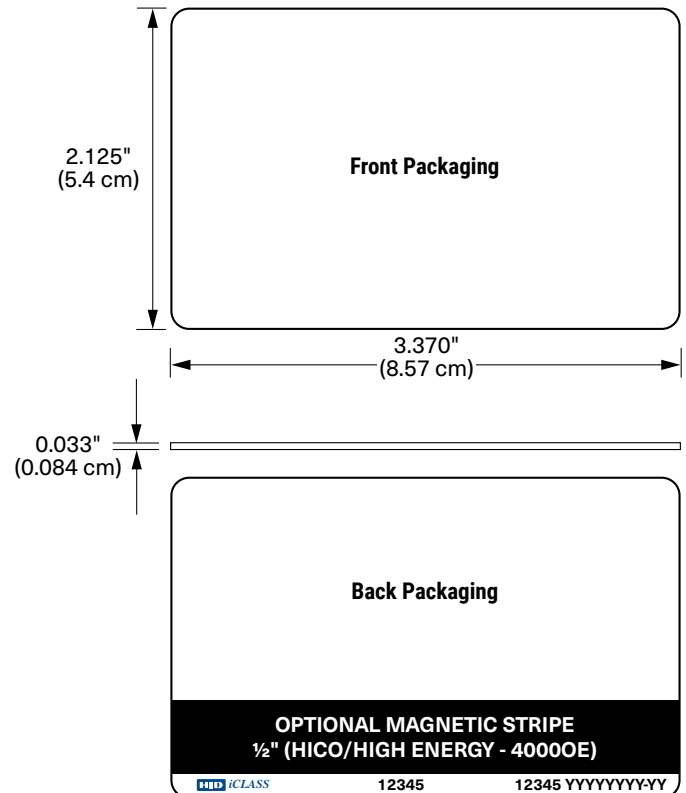

12345 = Card ID Number
YYYYYYY-YY = Sales Order Number



iCLASS SE Card Numbering³ (select one option)

- M** - Sequential Matching Encoded/Printed (Inkjetted)⁵
- N** - No Printed Card Numbering
- S** - Sequential Encoded/Sequential Non-Matching Printed (Inkjetted)⁴
- R** - Random Encoded/Non-Matching Sequential Printed (Inkjetted)⁴
- A** - Sequential Matching Encoded/Printed (Laser Engraved)
- B** - Sequential Encoded/Sequential Non-Matching Printed (Laser Engraved)
- C** - Random Encoded/Non-Matching Sequential Printed (Laser Engraved)

Slot Punch

IMPORTANT: Dual High Frequency credentials do not allow a slot punch due to the antenna design. HID recommends using a badge holder to attach this card to a lanyard or badge clip.

- N** - No Slot Punch

MIFARE Classic 13.56 MHz Card Numbering³ (select one option)

- M** - Sequential Matching Encoded/Printed (Inkjetted)⁵
- N** - No Printed Card Numbering
- S** - Sequential Encoded/Sequential Non-Matching Printed (Inkjetted)⁴
- R** - Random Encoded/Non-Matching Sequential Printed (Inkjetted)⁴
- A** - Sequential Matching Encoded/Printed (Laser Engraved)
- B** - Sequential Encoded/Sequential Non-Matching Printed (Laser Engraved)
- C** - Random Encoded/Non-Matching Sequential Printed (Laser Engraved)

125 kHz Card Numbering³ (select one option)

- M** - Sequential Matching Encoded/Printed (Inkjetted)⁵
- N** - No Printed Card Numbering
- S** - Sequential Encoded/Sequential Non-Matching Printed (Inkjetted)⁴
- R** - Random Encoded/Non-Matching Sequential Printed (Inkjetted)⁴
- A** - Sequential Matching Encoded/Printed (Laser Engraved)
- B** - Sequential Encoded/Sequential Non-Matching Printed (Laser Engraved)
- C** - Random Encoded/Non-Matching Sequential Printed (Laser Engraved)

Option - Custom Artwork¹

_____ (Specify Artwork Number - Refer to the Custom Artwork Forms for new artwork)

Enter your final card options from the above selections. Example: 3964PNP GNNM

Final Part Number									N				-	(Options #)
-------------------	--	--	--	--	--	--	--	--	---	--	--	--	---	-------------

iCLASS SE Programming Information

Format Number	Field Name(s) e.g. Facility Code	Value	QTY	Encoded Start Number	Encoded Stop Number
HID Elite ICE #				Printed Start Number	Printed Stop Number



MIFARE Classic Programming Information

Format Number	Field Name(s) e.g. Facility Code	Value	QTY	Encoded Start Number	Encoded Stop Number
HID Elite ICE #				Printed Start Number	Printed Stop Number

125 kHz Programming Information

Format Number	Field Name(s) e.g. Facility Code	Value	QTY	Encoded Start Number	Encoded Stop Number
				Printed Start Number	Printed Stop Number

¹ For new artwork files, contact Customer Service for custom artwork number, lead-times, and cost.

² Cards ordered with plain white front and back packaging, or custom artwork, will still have a small HID logo  and reference number printed in the lower left-hand corner and a slot punch target printed on the back of the card. Most part numbers are marked with the sales order number. A custom part number is required to omit all marking from the card. Contact your local support representative for details.

³ The Printed card number is placed in the bottom right-hand corner for iCLASS 13.56 MHz and in the bottom center for 125 kHz Proximity on the back of the card.

⁴ Please note that cards shipped within the Americas are always laser-engraved. Inkjetted option is not available for these cards.

* The composite construction is recommended for all cards with over-laminate applied. Consult with the printer manufacturer prior to ordering.

iCLASS Credentials

iCLASS Card - 200 / 210

iCLASS cards can be ordered either with both SIO and iCLASS programming or iCLASS programming only.

Ensure each required option has been checked with the appropriate choice to fulfill a completed order form.

Base Model: **200 Standard PVC** **210 Composite 40% Polyester / PVC***

iCLASS Memory Size and Allocation (select one option)

- 0** - 2k Bits (256 Bytes) with 2 Application Areas
- 3** - 32k Bits (4K Bytes) Application areas 16k/2+16k/1
- 4** - 32k Bits (4K Bytes) Application areas 16k/16+16k/1

iCLASS Programming (select one option)

- HP** - Programmed with Security Identity Object (SIO) and standard iCLASS Access Control Application (**Recommended**)¹
- P** - Programmed with standard iCLASS Access Control Application
- C** - Unprogrammed, for use with iCLASS SE Encoder

Front Packaging (select one option)

- G** - Plain White with Gloss Finish
- C** - Custom Artwork with Gloss Finish - Specify Custom Artwork Number²

Back Packaging (select one option)

- G** - Plain White with Gloss Finish³
- C** - Custom Artwork with Gloss Finish - Specify Custom Artwork Number²
- 1** - Plain White with Gloss Finish with Magnetic Stripe³
- 3** - Custom Artwork with Gloss Finish with Magnetic Stripe - Specify Custom Artwork Number²

Card Numbering⁴ (select one option)

- M** - Sequential Matching Encoded/Printed (Inkjetted)⁸
- N** - No Printed Card Numbering
- S** - Sequential Encoded/Sequential Non-Matching Printed (Inkjetted)⁷
- R** - Random Encoded/Non-Matching Sequential Printed (Inkjetted)⁷
- A** - Sequential Matching Encoded/Printed (Laser Engraved)
- B** - Sequential Encoded/Sequential Non-Matching Printed (Laser Engraved)
- C** - Random Encoded/Non-Matching Sequential Printed (Laser Engraved)

Slot Punch⁵ (select one option)

- N** - No slot punch, This card can be slotted vertically, Printed Vertical Slot Indicators
- B** - No Slot Punch, This card can be slotted horizontally, Printed Horizontal Slot Indicators⁷
- V** - Vertical Slot Punch
- H** - Horizontal Slot Punch⁶

Option - Custom Artwork²

_____ (Specify Artwork Number - Refer to the Custom Artwork Forms for new artwork)

Enter your final card options from check boxes above. Example: 2000HPGGNN

Final Part Number								-	(Options #)
-------------------	--	--	--	--	--	--	--	---	-------------

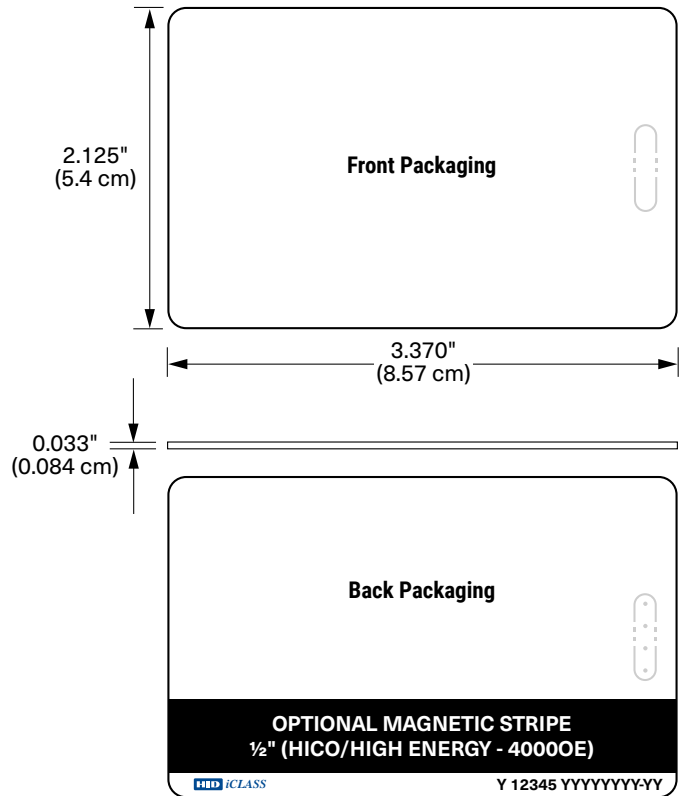

Y = iCLASS Programming
12345 = Card ID Number
YYYYYYY-YY = Sales Order Number



iCLASS Card Programming Information

Format Number	Field Name(s) e.g. Facility Code	Value	QTY	Encoded Start Number	Encoded Stop Number
HID Elite ICE #				Printed Start Number	Printed Stop Number

¹ Secure Identity Object (SIO) Programming is not mandatory but highly recommended. If SIO programming is not selected the letter H should be left out from Final Part Number, for example: 2000PGGNN

² For new artwork files, contact Customer Service for custom artwork number, lead-times, and cost.

³ Cards ordered with plain white front and back packaging, or custom artwork, will still have a small HID logo  and reference number printed in the lower left-hand corner and a slot punch target printed on the back of the card. Most part numbers are marked with sales order number. A custom part number is required to omit all marking from the card. Contact your local support representative for details.

⁴ The Printed card number is placed in the bottom right-hand corner on the back of the card.

⁵ Cards are provided with an optional slot punch at no additional charge. Some video imaging printers cannot accommodate pre-slot punched cards.

⁶ The ability to add a horizontal slot punch requires a different iCLASS antenna design. Users can expect a read range reduction of approximately 20% if they order option H for the Slot Punch.

⁷ Please note that cards shipped within the Americas are always laser-engraved. Inkjetted option is not available for these cards.

* The composite construction is recommended for all cards with over-laminate applied. Consult with the printer manufacturer prior to ordering.

iCLASS + Prox Card - 212

iCLASS + Prox cards can be ordered either with both SIO and iCLASS programming or iCLASS programming only, a composite fee applies to this card.

Ensure each required option has been checked with the appropriate choice to fulfill a completed order form.

Base Model **212 Composite 40% Polyester / PVC***

iCLASS Memory Size and Allocation (select one option)

- 0** - 2k Bits (256 Bytes) with 2 Application Areas
- 3** - 32k Bits (4K Bytes) Application areas 16k/2+16k/1
- 4** - 32k Bits (4K Bytes) Application areas 16k/16+16k/1

Programming (select one option)

- HP** - Programmed with Security Identity Object (SIO), and standard iCLASS access control application, 25 kHz Unprogrammed.¹
- HB** - Programmed with Security Identity Object (SIO), and standard iCLASS access control application, 125 kHz 125 kHz programmed with HID Prox or Indala format
- P** - Programmed with standard iCLASS access control application, 125 kHz HID Prox unprogrammed for use with iCLASS SE Encoder
- B** - 125 kHz Programmed with HID Prox or Indala format, iCLASS programmed with standard access control application
- C** - iCLASS Unprogrammed, for use with iCLASS SE Encoder, HID Prox unprogrammed for use with iCLASS SE Encoder
- A** - iCLASS Unprogrammed, for use with iCLASS SE Encoder, 125 kHz programmed with HID Prox or Indala format
- M** - iCLASS Programmed, HITAG2 blank.
- I** - iCLASS configured field programmable, HITAG2 blank.

Front Packaging (select one option)

- G** - Plain White with Gloss Finish
- C** - Custom Artwork with Gloss Finish - Specify Custom Artwork Number²

Back Packaging (select one option)

- G** - Plain White with Gloss Finish³
- C** - Custom Artwork with Gloss Finish - Specify Custom Artwork Number²
- 1** - Plain White with Gloss Finish with Magnetic Stripe³
- 3** - Custom Artwork with Gloss Finish with Magnetic Stripe - Specify Custom Artwork Number²

iCLASS Card Numbering⁴ (select one option)

- M** - Sequential Matching Encoded/Printed (Inkjetted)⁷
- N** - No Printed Card Numbering
- S** - Sequential Encoded/Sequential Non-Matching Printed (Inkjetted)⁶
- R** - Random Encoded/Non-Matching Sequential Printed (Inkjetted)⁶
- A** - Sequential Matching Encoded/Printed (Laser Engraved)
- B** - Sequential Encoded/Sequential Non-Matching Printed (Laser Engraved)
- C** - Random Encoded/Non-Matching Sequential Printed (Laser Engraved)

Slot Punch⁵ (select one option)

- V** - Vertical Slot Punch
- N** - No slot punch, This card can be slotted vertically, Printed Vertical Slot Indicators

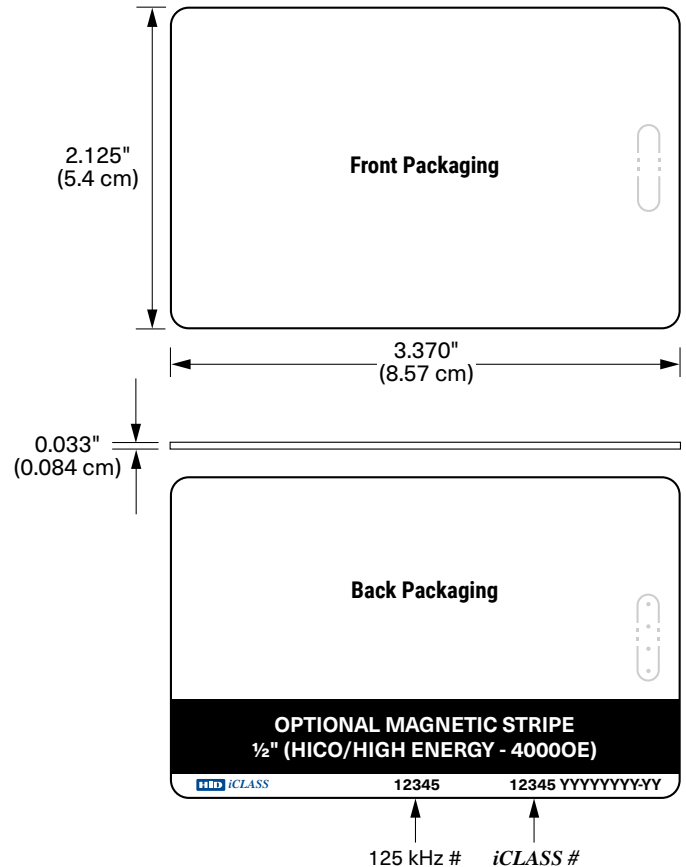

12345 = Card ID Number
YYYYYYY-YY = Sales Order Number

125 kHz Card Numbering⁴ (select one option)

- M** - Sequential Matching Encoded/Printed (Inkjetted)⁷
- N** - No Printed Card Numbering
- S** - Sequential Encoded/Sequential Non-Matching Printed (Inkjetted)⁶
- R** - Random Encoded/Non-Matching Sequential Printed (Inkjetted)⁶
- A** - Sequential Matching Encoded/Printed (Laser Engraved)
- B** - Sequential Encoded/Sequential Non-Matching Printed (Laser Engraved)
- C** - Random Encoded/Non-Matching Sequential Printed (Laser Engraved)

Option - Custom Artwork²

_____ (Specify Artwork Number - Refer to the Custom Artwork Forms for new artwork)

Enter your final card options from the above selections. Example: 2120HPGGNNN

Final Part Number									-	(Options #)
--------------------------	--	--	--	--	--	--	--	--	---	-------------

iCLASS Card Programming Information

Format Number	Field Name(s) e.g. Facility Code	Value	QTY	Encoded Start Number	Encoded Stop Number
HID Elite ICE #				Printed Start Number	Printed Stop Number

125 kHz Card Programming Information

Format Number	Field Name(s) e.g. Facility Code	Value	QTY	Encoded Start Number	Encoded Stop Number
				Printed Start Number	Printed Stop Number

¹ Secure Identity Object (SIO) Programming is not mandatory but highly recommended. If SIO programming is not selected the letter H should be left out from Final Part Number, for example: 2120PGGNNN

² For new artwork files, contact Customer Service for custom artwork number, lead-times, and cost.

³ Cards ordered with plain white front and back packaging, or custom artwork, will still have a small HID logo  and reference number printed in the lower left-hand corner and a slot punch target printed on the back of the card. Most part numbers are marked with sales order number. A custom part number is required to omit all marking from the card. Contact your local support representative for details.

⁴ The Printed card number is placed in the bottom right-hand corner for iCLASS 13.56 MHz and in the bottom center for 125 kHz Proximity on the back of the card.

⁵ Cards are provided with an optional slot punch at no additional charge. Some video imaging printers cannot accommodate pre-slot punched cards.

⁶ Please note that cards shipped within North America are always laser-engraved. Inkjetted option is not available for these cards.

* The composite construction is recommended for all cards with over-laminate applied. Consult with the printer manufacturer prior to ordering.

iCLASS Key - 205

The iCLASS Key can be ordered either with both SIO and iCLASS programming or iCLASS programming only. Attach to a key ring or badge clip for convenient use.

Ensure each required option has been checked with the appropriate choice to fulfill a completed order form.

Base Model **205 Base Model**

iCLASS Memory Size and Allocation (select one option)

- 0** - 2k Bits (256 Bytes) with 2 Application Areas
- 3** - 32k Bits (4K Bytes) Application areas 16k/2+16k/1
- 4** - 32k Bits (4K Bytes) Application areas 16k/16+16k/1

Programming (select one option)

- H** - Programmed with Security Identity Object (SIO) and standard iCLASS access control application (**Recommended**)
- P** - Programmed iCLASS standard access control application only
- C** - iCLASS Unprogrammed, for use with iCLASS SE Encoder

Front Packaging

- N** - iCLASS Key II - Black with blue insert. Includes HID Standard Artwork

Back Packaging

- N** - None

Key Numbering¹ (select one option)

- M** - Sequential Matching Encoded/Printed (Inkjetted)⁴
- N** - No Printed Key Numbering
- S** - Sequential Encoded/Sequential Non-Matching Printed (Inkjetted)³
- R** - Random Encoded/Non-Matching Sequential Printed (Inkjetted)³
- A** - Sequential Matching Encoded/Printed (Engraved)
- B** - Sequential Encoded/Sequential Non-Matching Printed (Engraved)
- C** - Random Encoded/Non-Matching Sequential Printed (Engraved)

Additional Options³

- N** - None

Enter your final card options from the above selections. Example: 2050HNNMN

Final Part Number	205			N	N		N
-------------------	-----	--	--	---	---	--	---

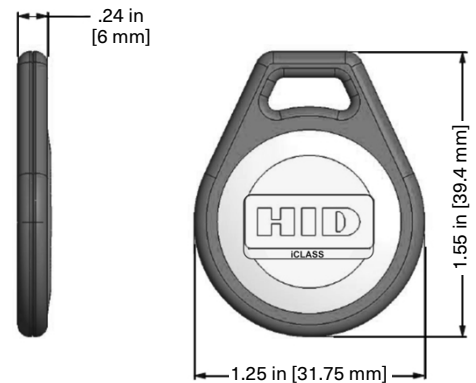

iCLASS Key Programming Information

Format Number	Field Name(s) e.g. Facility Code	Value	QTY	Encoded Start Number	Encoded Stop Number
HID Elite ICE #				Printed Start Number	Printed Stop Number

¹ The Printed key number is placed on the back of the key.

² Key Ring sold separately (Part Number: 57-0001-02).

³ Please note that cards shipped within the Americas are always laser-engraved. Inkjetted option is not available for these cards.

iCLASS Tag - 206

The iCLASS contactless smart Tag can be ordered either with both SIO and iCLASS programming or iCLASS programming only. iCLASS enable existing credentials or non-metallic devices such as cell phones or PDAs by adhering the iCLASS Tag.

Ensure each required option has been checked with the appropriate choice to fulfill a completed order form.

206 Base Model

iCLASS Memory Size and Allocation (select one option)

- 0 - 2k Bits (256 Bytes) with 2 Application Areas
- 3 - 32k Bits (4K Bytes) Application areas 16k/2+16k/1
- 4 - 32k Bits (4K Bytes) Application areas 16k/16+16k/1

iCLASS Programming information (select one option)

- H - Programmed with Security Identity Object (SIO) and standard iCLASS access control application. (Recommended)
- P - Programmed with iCLASS access control application only
- C - iCLASS Unprogrammed, for use with iCLASS SE Encoder

Front Packaging (select one option)

- K - Black with HID Standard Artwork
- C - Custom Artwork - Specify Custom Artwork Number²

Back Packaging

- S - Adhesive Backing

Tag Numbering¹ (select one option)

- M - Sequential Matching Encoded/Printed (Inkjetted)⁴
- N - No Printed Tag Numbering
- S - Sequential Encoded/Sequential Non-Matching Printed (Inkjetted)⁴
- R - Random Encoded/Non-Matching Sequential Printed (Inkjetted)⁴

Slot Punch

- N - None

Option - Custom Artwork¹

_____ (Specify Artwork Number - Refer to the Custom Artwork Forms for new artwork)

Enter your final Tag options from check boxes above. Example: 206HSSNN

Final Part Number	206				S		N	-	(Options #)
-------------------	-----	--	--	--	---	--	---	---	-------------

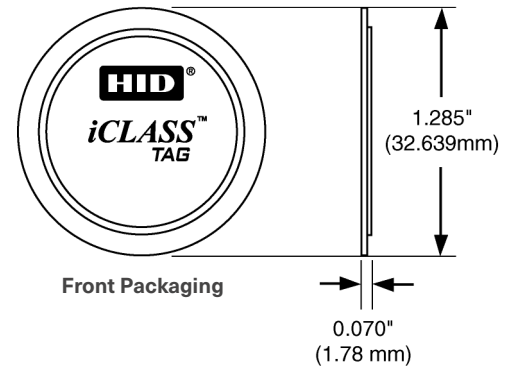

iCLASS Tag Programming Information

Format Number	Field Name(s) e.g. Facility Code	Value	QTY	Encoded Start Number	Encoded Stop Number
HID Elite ICE #				Printed Start Number	Printed Stop Number

¹ The Printed tag number is placed on the back of the tag. In order to support laser marking technology HID will be transitioning from a white release paper to a black release paper. Please consult your sales Account Manager for more information.

² For new artwork files, contact Customer Service for custom artwork number, lead-times, minimum order quantities, and cost.

³ The iCLASS Tag is not for use on cards that use full insertion or tractor feed type readers.

⁴ Please note that cards shipped out of the Americas are always laser-engraved. Inkjetted option is not available for these cards.

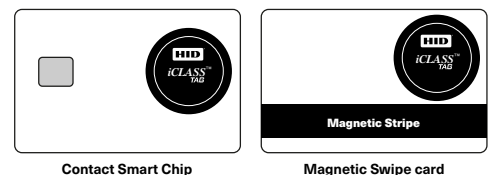

Do not adhere to metal surfaces. Metal shields the RF, making the tag inoperable. Due to variations in cards and reading devices, HID does not claim that the iCLASS Tag will work in every situation. Functional and non-functional iCLASS Tags are available for compatibility testing with existing credential and reader technologies. Compatibility should be confirmed prior to ordering.

iCLASS Clamshell Card - 208

Can be ordered either with both SIO and iCLASS programming or iCLASS programming only.

Ensure each required option has been checked with the appropriate choice to fulfill a completed order form.

208 Base Model

iCLASS Memory Size and Allocation

0 - 2k Bits (256 Bytes) with 2 Application Areas

iCLASS Programming (select one option)

- HP** - Programmed with Security Identity Object (SIO) and standard iCLASS access control application. **(Recommended)**¹
- P** - Programmed with standard iCLASS access control application only
- C** - iCLASS Unprogrammed, for use with iCLASS SE Encoder

Front Packaging (select one option)

- M** - Plain White Vinyl with Matte Finish
- G** - Plain White with Gloss Finish
- C** - Custom Artwork - Specify Custom Artwork Number²

Back Packaging (select one option)

- S** - Base with Molded HID Logo
- C** - Custom Artwork - Specify Custom Artwork Number²

Card Numbering³ (select one option)

- M** - Sequential Matching Encoded/Printed (Inkjetted)³
- N** - No Printed Card Numbering
- S** - Sequential Encoded/Sequential Non-Matching Printed (Inkjetted)³
- R** - Random Encoded/Non-Matching Sequential Printed (Inkjetted)³

Slot Punch

V - Vertical Slot Punch

Option - Custom Artwork²

_____ (Specify Artwork Number - Refer to the Custom Artwork Forms for new Artwork)

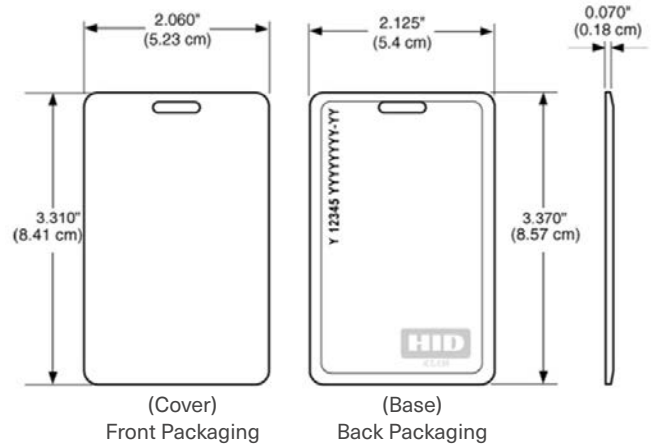

Y = iCLASS Programming
12345 = Card ID Number
YYYYYYY-YY = Sales Order Number

Enter your final card options from check boxes above. Example: 2080HPGSNV

Final Part Number	208						V	-	(Options #)
-------------------	-----	--	--	--	--	--	---	---	-------------

iCLASS Card Programming Information

Format Number	Field Name(s) e.g. Facility Code	Value	QTY	Encoded Start Number	Encoded Stop Number
HID Elite ICE #				Printed Start Number	Printed Stop Number

¹ Secure Identity Object (SIO) Programming is not mandatory but highly recommended. If SIO programming is not selected the letter H should be left out from Final Part Number, for example: 2080PGSNV

² For new artwork files, contact Customer Service for custom artwork number, lead-times, and cost.

³ Please note that cards shipped within the Americas are always laser-engraved. Inkjetted option is not available for these cards. Most part numbers include a printed Sales Order number, contact your local support representative for full details.

iCLASS + MIFARE Classic - 242

iCLASS with MIFARE Classic contactless smart card offers multiple High Frequency technologies to simplify card issuance for diverse systems or migration projects. This credential is only delivered with MIFARE Classic UID 4 Bytes long only (32 Bit). It is not available with 7 bytes UID.

Ensure each required option has been checked with the appropriate choice to fulfill a completed order form.

Base Model **242 Composite 40% Polyester / PVC***

iCLASS Memory Size and Allocation (select one option)

- 0** - 2k Bits (256 Bytes) with 2 Application Areas (only available with MIFARE Classic 1K)
- 3** - 32k Bits (4K Bytes) Application areas 16k/2+16k/1
- 4** - 32k Bits (4K Bytes) Application areas 16k/16+16k/1

Card Programming (select one option)

- J** - iCLASS programmed with Security Identity Object (SIO) and iCLASS standard access control application, MIFARE Classic programmed with Security Identity Object (SIO)
- H** - iCLASS programmed with Security Identity Object (SIO) and iCLASS standard access control application, MIFARE Classic unprogrammed
- B** - iCLASS programmed with iCLASS standard access control application, MIFARE Classic programmed with HID MIFARE (MIFARE Classic)
- P** - iCLASS programmed with iCLASS standard access control application, MIFARE Classic unprogrammed
- C** - Unprogrammed iCLASS, for use with iCLASS SE Encoder, Non-programmed MIFARE Classic
- A** - iCLASS unprogrammed, for use with iCLASS SE Encoder, MIFARE Classic programmed with HID MIFARE (MIFARE Classic)

MIFARE Classic (select one option)

- M** - MIFARE Classic 1K Bytes (only available with iCLASS 2k bits)
- N** - MIFARE Classic 4K Bytes

Front Packaging (select one option)

- G** - Plain White with Gloss Finish
- C** - Custom Artwork with Gloss Finish - Specify Custom Artwork Number¹

Back Packaging (select one option)

- G** - Plain White with Gloss Finish²
- C** - Custom Artwork with Gloss Finish - Specify Custom Artwork Number¹
- 1** - Plain White with Gloss Finish with Magnetic Stripe²
- 3** - Custom Artwork with Gloss Finish with Magnetic Stripe - Specify Custom Artwork Number¹

iCLASS Card Numbering³ (select one option)

- M** - Sequential Matching Encoded/Printed (Inkjetted)⁵
- N** - No Printed Card Numbering
- S** - Sequential Encoded/Sequential Non-Matching Printed (Inkjetted)⁵
- R** - Random Encoded/Non-Matching Sequential Printed (Inkjetted)⁵
- A** - Sequential Matching Encoded/Printed (Laser Engraved)
- B** - Sequential Encoded/Sequential Non-Matching Printed (Laser Engraved)
- C** - Random Encoded/Non-Matching Sequential Printed (Laser Engraved)

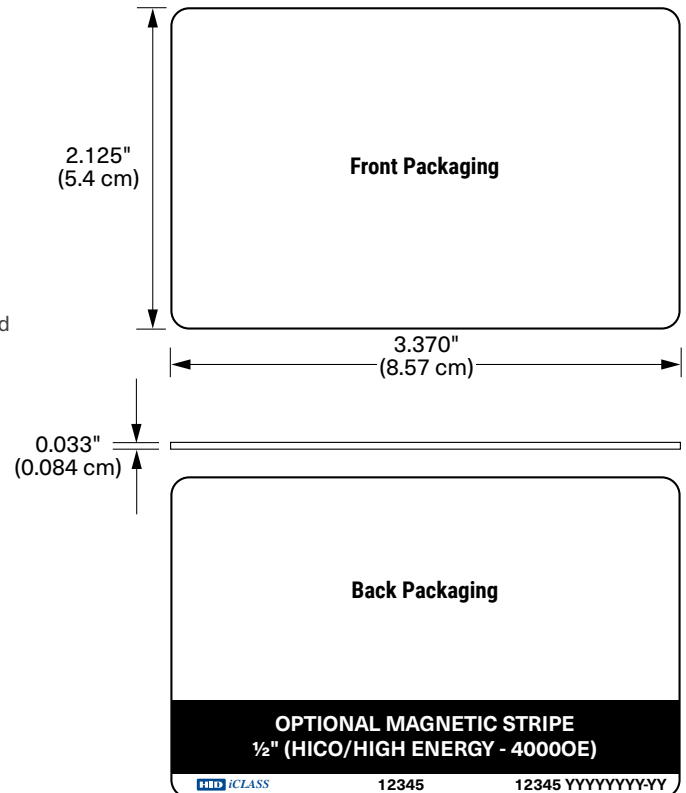

12345 = Card ID Number
YYYYYYY-YY = Sales Order Number



Slot Punch

IMPORTANT: Dual High Frequency credentials do not allow a slot punch due to the antenna design. HID recommends using a badge holder to attach this card to a lanyard or badge clip.

N - No Slot Punch

MIFARE Classic Card Numbering³ (select one option)

- M** - Sequential Matching Encoded/Printed (Inkjetted)⁶
- N** - No Printed Card Numbering
- S** - Sequential Encoded/Sequential Non-Matching Printed (Inkjetted)⁵
- R** - Random Encoded/Non-Matching Sequential Printed (Inkjetted)⁵
- A** - Sequential Matching Encoded/Printed (Laser Engraved)
- B** - Sequential Encoded/Sequential Non-Matching Printed (Laser Engraved)
- C** - Random Encoded/Non-Matching Sequential Printed (Laser Engraved)

Option - Custom Artwork¹

_____ (Specify Artwork Number - Refer to the Custom Artwork Forms for new artwork)

Enter your final card options from the above selections. Example: 2420HNGGNNN

Final Part Number						N		-	(Options #)
-------------------	--	--	--	--	--	---	--	---	-------------

iCLASS Card Programming Information

Format Number	Field Name(s) e.g. Facility Code	Value	QTY	Encoded Start Number	Encoded Stop Number
HID Elite ICE #				Printed Start Number	Printed Stop Number

MIFARE Classic Card Programming Information

Format Number	Field Name(s) e.g. Facility Code	Value	QTY	Encoded Start Number	Encoded Stop Number
HID Elite ICE #				Printed Start Number	Printed Stop Number

¹ For new artwork files, contact Customer Service for custom artwork number, lead-times, and cost.

² Cards ordered with plain white front and back packaging, or custom artwork, will still have a small HID logo and reference number printed in the lower left-hand corner and a slot punch target printed on the back of the card. Most part numbers are marked with sales order number. A custom part number is required to omit all marking from the card. Contact your local support representative for details.

³ The Printed card number is placed in the bottom right-hand corner for iCLASS 13.56 MHz and in the bottom center for 125 kHz Proximity on the back of the card.

⁴ Cards are provided with an optional slot punch at no additional charge. Some video imaging printers cannot accommodate pre-slot punched cards.

⁵ Please note that cards shipped within the Americas are always laser-engraved. Inkjetted option is not available for these cards.

* The composite construction is recommended for all cards with over-laminate applied. Consult with the printer manufacturer prior to ordering.

iCLASS + MIFARE Classic + Prox Card - 262

The iCLASS with MIFARE Classic contactless smart card as well as HID Proximity offers multiple High Frequency technologies to simplify card issuance for diverse systems or migration projects. This credential is only delivered with MIFARE Classic UID on 4 Bytes long only (32 Bit). It is not available with 7 bytes UID.

Ensure each required option has been checked with the appropriate choice to fulfill a completed order form.

Base Model **262 Composite 40% Polyester / PVC***

iCLASS Memory Size and Allocation (select one option)

- 0** - 2k Bits (256 Bytes) with 2 Application Areas (only available with MIFARE Classic 1K)
- 3** - 32k Bits (4K Bytes) Application areas 16k/2+16k/1
- 4** - 32k Bits (4K Bytes) Application areas 16k/16+16k/1

iCLASS / MIFARE Classic Programming

- J** - iCLASS programmed with Security Identity Object (SIO) and iCLASS standard access control application, MIFARE Classic programmed with Security Identity Object (SIO)
- H** - iCLASS programmed with Security Identity Object (SIO) and iCLASS standard access control application, MIFARE Classic unprogrammed
- K** - iCLASS programmed with Secure Identity Object (SIO) and iCLASS standard access control application, MIFARE Classic programmed with HID MIFARE (MIFARE Classic)
- B** - iCLASS programmed with iCLASS standard access control application, MIFARE Classic programmed with HID MIFARE (MIFARE Classic)
- P** - iCLASS programmed with iCLASS standard access control application, MIFARE Classic unprogrammed
- C** - iCLASS unprogrammed, for use with iCLASS SE Encoder, MIFARE Classic unprogrammed
- A** - iCLASS unprogrammed, for use with iCLASS SE Encoder, MIFARE Classic programmed with HID MIFARE (MIFARE Classic).

MIFARE Classic (select one option)

- M** - MIFARE Classic 1K Bytes (only available with iCLASS 2k bits)
- N** - MIFARE Classic 4K Bytes

125 kHz Technology Card Programming (select one option)

- P** - Programmed with HID Prox or Indala format.
- C** - Programmed with Indala CX (Casi Prox)
- N** - Unprogrammed HID Prox, for use with iCLASS SE Encoder

Front Packaging (select one option)

- G** - Plain White with Gloss Finish
- C** - Custom Artwork with Gloss Finish - Specify Custom Artwork Number¹

Back Packaging (select one option)

- G** - Plain White with Gloss Finish²
- C** - Custom Artwork with Gloss Finish - Specify Custom Artwork Number¹
- 1** - Plain White with Gloss Finish with Magnetic Stripe²
- 3** - Custom Artwork with Gloss Finish with Magnetic Stripe – Specify Custom Artwork Number¹

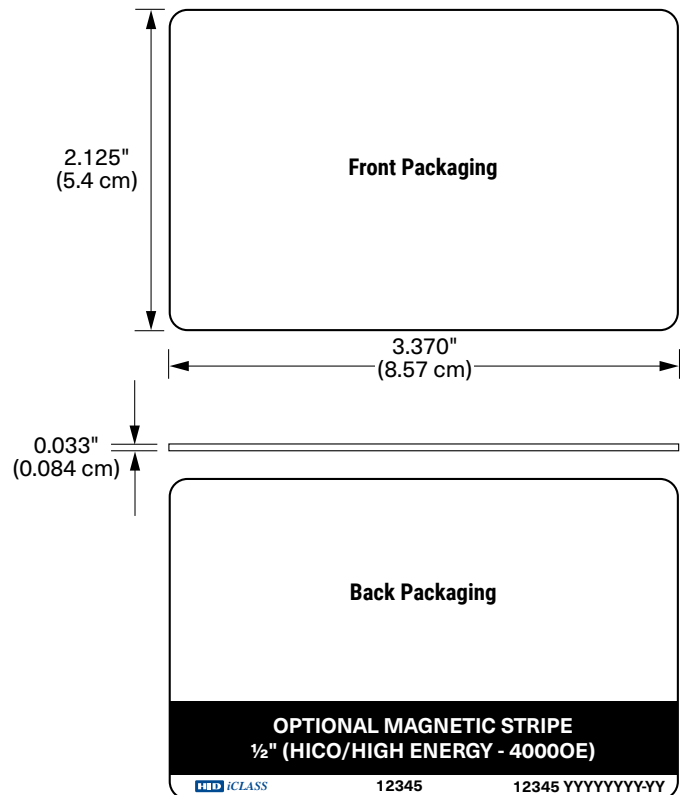



iCLASS Card Numbering³ (select one option)

- M - Sequential Matching Encoded/Printed (Inkjetted)⁵
- N - No Printed Card Numbering
- S - Sequential Encoded/Sequential Non-Matching Printed (Inkjetted)⁵
- R - Random Encoded/Non-Matching Sequential Printed (Inkjetted)⁵
- A - Sequential Matching Encoded/Printed (Laser Engraved)⁴
- B - Sequential Encoded/Sequential Non-Matching Printed (Laser Engraved)⁴
- C - Random Encoded/Non-Matching Sequential Printed (Laser Engraved)⁴

Slot Punch

IMPORTANT: Dual High Frequency credentials do not allow a slot punch due to the antenna design. HID recommends using a badge holder to attach this card to a lanyard or badge clip.

- N - No Slot Punch

MIFARE Classic 13.56 MHz Card Numbering³ (select one option)

- M - Sequential Matching Encoded/Printed (Inkjetted)⁵
- N - No Printed Card Numbering
- S - Sequential Encoded/Sequential Non-Matching Printed (Inkjetted)⁴
- R - Random Encoded/Non-Matching Sequential Printed (Inkjetted)⁴
- A - Sequential Matching Encoded/Printed (Laser Engraved)
- B - Sequential Encoded/Sequential Non-Matching Printed (Laser Engraved)
- C - Random Encoded/Non-Matching Sequential Printed (Laser Engraved)

125 kHz Card Numbering³ (select one option)

- M - Sequential Matching Encoded/Printed (Inkjetted)⁴
- N - No Printed Card Numbering
- S - Sequential Encoded/Sequential Non-Matching Printed (Inkjetted)⁴
- R - Random Encoded/Non-Matching Sequential Printed (Inkjetted)⁴
- A - Sequential Matching Encoded/Printed (Laser Engraved)
- B - Sequential Encoded/Sequential Non-Matching Printed (Laser Engraved)
- C - Random Encoded/Non-Matching Sequential Printed (Laser Engraved)

Option - Custom Artwork¹

- _____ (Specify Artwork Number - Refer to the Custom Artwork Forms for new artwork)

Enter your final card options from the above selections. Example: 2624JNGGNNN

Final Part Number								N			-			(Options #)
-------------------	--	--	--	--	--	--	--	---	--	--	---	--	--	-------------

iCLASS Card Programming Information

Format Number	Field Name(s) e.g. Facility Code	Value	QTY	Encoded Start Number	Encoded Stop Number
HID Elite ICE #				Printed Start Number	Printed Stop Number



MIFARE Classic Card Programming Information

Format Number	Field Name(s) e.g. Facility Code	Value	QTY	Encoded Start Number	Encoded Stop Number
HID Elite ICE #				Printed Start Number	Printed Stop Number

125 kHz Card Programming Information

Format Number	Field Name(s) e.g. Facility Code	Value	QTY	Encoded Start Number	Encoded Stop Number
				Printed Start Number	Printed Stop Number

¹ For new artwork files, contact Customer Service for custom artwork number, lead-times, and cost.

² Cards ordered with plain white front and back packaging, or custom artwork, will still have a small HID logo  and reference number printed in the lower left-hand on the back of the card. Most part numbers are marked with the sales order number. A custom part number is required to omit all marking from the card. Contact your local support representative for details.

³ The Printed card number is placed in the bottom right-hand corner for iCLASS 13.56 MHz and in the bottom center for 125 kHz Proximity on the back of the card.

⁴ Please note that cards shipped within the Americas are always laser-engraved. Inkjetted option is not available for these cards.

* The composite construction is recommended for all cards with over-laminate applied. Consult with the printer manufacturer prior to ordering.

UHF Credentials

UHF Card - 600

The SIO Enabled UHF (Ultra High Frequency: 860-960 MHz) contactless smart card is designed for long read range (parking, gate, healthcare...) while leveraging your investment in existing access control systems. Personalize the card with a photo ID, magnetic stripe, barcode, or anti-counterfeiting element. **Direct to Card printing on these cards is not recommended.**

Ensure each required option has been checked with the appropriate choice to fulfill a completed order form.

Base Model **600 Composite 40% Polyester / PVC***

Secure Identity Object Programming

T - UHF Programmed with Secure Identity Object (SIO)

Front Packaging (select one option)

- G** - Plain White with Gloss Finish
- C** - Custom Artwork with Gloss Finish - Specify Custom Artwork Number¹

Back Packaging (select one option)

- G** - Plain White with Gloss Finish²
- C** - Custom Artwork with Gloss Finish - Specify Custom Artwork Number¹
- 1** - Plain White with Gloss Finish with Magnetic Stripe²
- 3** - Custom Artwork with Gloss Finish with Magnetic Stripe - Specify Custom Artwork Number¹

UHF Card Numbering³ (select one option)

- N** - No Printed Card Numbering
- A** - Sequential Matching Encoded/Printed (Laser Engraved)
- B** - Sequential Encoded/Sequential Non-Matching Printed (Laser Engraved)
- C** - Random Encoded/Non-Matching Sequential Printed (Laser Engraved)

Slot Punch

N - No Slot Punch

Option - Custom Artwork¹

(Specify Artwork Number - Refer to the Custom Artwork Forms for new artwork)

Enter your final card options from the above selections. Example: 600TGNN

Final Part Number	600	T				N	-	(Options #)
-------------------	-----	---	--	--	--	---	---	-------------

UHF Programming Information⁵

Format Number	Field Name(s) e.g. Facility Code	Value	QTY	Encoded Start Number	Encoded Stop Number
HID Elite ICE #				Printed Start Number	Printed Stop Number

¹ For new artwork files, contact Customer Service for custom artwork number, lead-times, and cost.

² Cards ordered with plain white front and back packaging, or custom artwork, will still have a small HID logo **HID** and reference number printed in the lower left-hand on the back of the card and include the sales order number. Most part numbers are marked with the sales order number. A custom part number is required to omit all marking from the card. Contact your local support representative for details.

³ The Printed card number is placed in the bottom right-hand corner for UHF.

⁵ Number of bits should remain below 120 bits.

* The composite construction is recommended for all cards with over-laminate applied. Consult with the printer manufacturer prior to ordering.

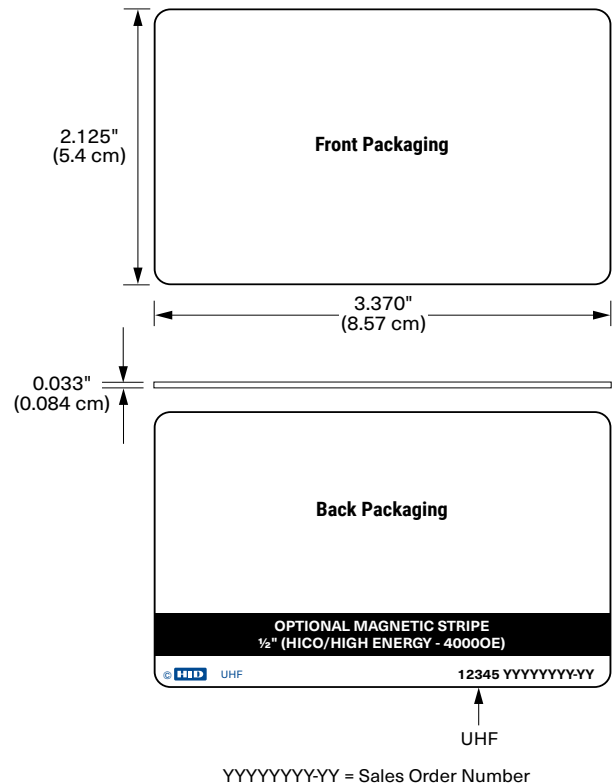

UHF + iCLASS Card - 601

The SIO enabled UHF/iCLASS smart card provides a secure long range parking and gate control solution that can be used in conjunction with existing access control technologies. Personalize the card with a photo ID, magnetic stripe, barcode, or anti-counterfeiting element. **Direct to Card printing on these cards is not recommended.**

Ensure each required option has been checked with the appropriate choice to fulfill a completed order form.

Base Model **601 Composite 40% Polyester / PVC***

iCLASS Memory Size and Allocation

- 3** - 32k Bits (4K Bytes) Application areas 16k/2+16k/1
- 4** - 32k Bits (4K Bytes) Application areas 16k/16+16k/1

Card Programming

- S** - UHF Programmed with Secure Identity Object (SIO). iCLASS programmed with standard iCLASS standard access control application and Secure Identity Object (SIO)
- T** - UHF Programmed with Secure Identity Object (SIO). iCLASS programmed with Secure Identity Object (SIO)
- H** - UHF Programmed with Secure Identity Object (SIO). iCLASS programmed with standard iCLASS access control application
- C** - UHF Programmed with Secure Identity Object (SIO). iCLASS unprogrammed for use with iCLASS SE Encoder

Front Packaging (select one option)

- G** - Plain White with Gloss Finish
- C** - Custom Artwork with Gloss Finish - Specify Custom Artwork Number¹

Back Packaging (select one option)

- G** - Plain White with Gloss Finish²
- C** - Custom Artwork with Gloss Finish - Specify Custom Artwork Number¹
- 1** - Plain White with Gloss Finish with Magnetic Stripe²
- 3** - Custom Artwork with Gloss Finish with Magnetic Stripe - Specify Custom Artwork Number¹

UHF Card Numbering³ (select one option)

- N** - No Printed Card Numbering
- A** - Sequential Matching Encoded/Printed (Laser Engraved)
- B** - Sequential Encoded/Sequential Non-Matching Printed (Laser Engraved)
- C** - Random Encoded/Non-Matching Sequential Printed (Laser Engraved)

iCLASS Card Numbering³ (select one option)

- N** - No Printed Card Numbering
- A** - Sequential Matching Encoded/Printed (Laser Engraved)
- B** - Sequential Encoded/Sequential Non-Matching Printed (Laser Engraved)
- C** - Random Encoded/Non-Matching Sequential Printed (Laser Engraved)

Slot Punch

- N** - No Slot Punch

Option - Custom Artwork¹

- _____ (Specify Artwork Number - Refer to the Custom Artwork Forms for new artwork)

Enter your final card options from the above selections. Example: 6013TGGNNN

Final Part Number	600	T				N	-	(Options #)
-------------------	-----	---	--	--	--	---	---	-------------

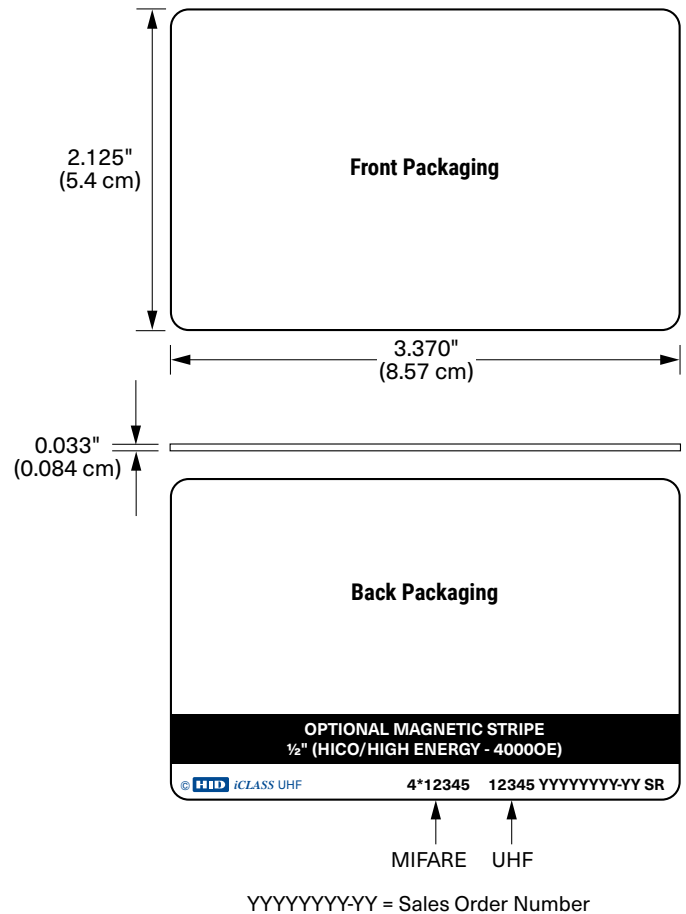



UHF Programming Information⁵

Format Number	Field Name(s) e.g. Facility Code	Value	QTY	Encoded Start Number	Encoded Stop Number
HID Elite ICE #				Printed Start Number	Printed Stop Number

iCLASS Programming Information

Format Number	Field Name(s) e.g. Facility Code	Value	QTY	Encoded Start Number	Encoded Stop Number
HID Elite ICE #				Printed Start Number	Printed Stop Number

¹ For new artwork files, contact Customer Service for custom artwork number, lead-times, and cost.

² Cards ordered with plain white front and back packaging, or custom artwork, will still have a small HID logo  and reference number printed in the lower left-hand on the back of the card. Most part numbers are marked with the sales order number. A custom part number is required to omit all marking from the card. Contact your local support representative for details.

³ The Printed card number is placed in the bottom right-hand corner for UHF.

⁵ Number of bits should remain below 120 bits.

* The composite construction is recommended for all cards with over-laminate applied. Consult with the printer manufacturer prior to ordering.

UHF + MIFARE Classic Card - 603

The SIO enabled UHF/MIFARE Classic smart card provides a secure long range parking and gate control solution that can be used in conjunction with existing access control technologies. Personalize the card with a photo ID, magnetic stripe, barcode, or anti-counterfeiting element. **Direct to Card printing on these cards is not recommended.**

Ensure each required option has been checked with the appropriate choice to fulfill a completed order form.

Base Model **603 Composite 40% Polyester / PVC***

Card Programming

- J** - UHF Programmed with Secure Identity Object (SIO), MIFARE programmed with Secure Identity Object (SIO)
- P** - UHF Programmed with Secure Identity Object (SIO), MIFARE non-programmed
- H** - UHF Programmed with Secure Identity Object (SIO), MIFARE programmed with HID MIFARE access control application
- K** - UHF Programmed with Secure Identity Object (SIO), MIFARE custom programmed (custom part suffix required)

MIFARE Memory Size and Allocation

- M** - 4K Bytes

Front Packaging (select one option)

- G** - Plain White with Gloss Finish
- C** - Custom Artwork with Gloss Finish - Specify Custom Artwork Number¹

Back Packaging (select one option)

- G** - Plain White with Gloss Finish²
- C** - Custom Artwork with Gloss Finish - Specify Custom Artwork Number¹
- 1** - Plain White with Gloss Finish with Magnetic Stripe²
- 3** - Custom Artwork with Gloss Finish with Magnetic Stripe - Specify Custom Artwork Number¹

UHF Card Numbering³ (select one option)

- N** - No Printed Card Numbering
- A** - Sequential Matching Encoded/Printed (Laser Engraved)
- B** - Sequential Encoded/Sequential Non-Matching Printed (Laser Engraved)⁴
- C** - Random Encoded/Non-Matching Sequential Printed (Laser Engraved)

Slot Punch

- N** - No Slot Punch

MIFARE Card Numbering³ (select one option)

- N** - No Printed Card Numbering
- A** - Sequential Matching Encoded/Printed (Laser Engraved)
- C** - Random Encoded/Non-Matching Sequential Printed (Laser Engraved)
- B** - Sequential Encoded/Sequential Non-Matching Printed (Laser Engraved)

Option - Custom Artwork¹

- (Specify Artwork Number - Refer to the Custom Artwork Forms for new artwork)

Enter your final card options from the above selections. Example: 603JMGGANA

Final Part Number	603						N		(Options #)
-------------------	-----	--	--	--	--	--	---	--	-------------

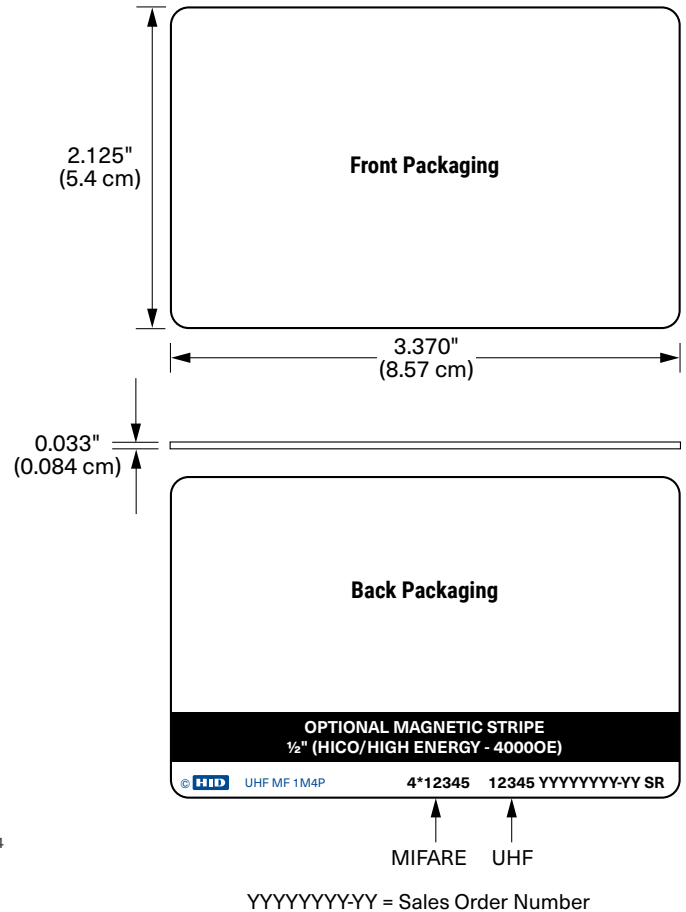



UHF Programming Information⁵

Format Number	Field Name(s) e.g. Facility Code	Value	QTY	Encoded Start Number	Encoded Stop Number
HID Elite ICE #				Printed Start Number	Printed Stop Number

MIFARE Programming Information

Format Number	Field Name(s) e.g. Facility Code	Value	QTY	Encoded Start Number	Encoded Stop Number
HID Elite ICE #				Printed Start Number	Printed Stop Number

¹ For new artwork files, contact Customer Service for custom artwork number, lead-times, and cost.

² Cards ordered with plain white front and back packaging, or custom artwork, will still have a small HID logo  and reference number printed in the lower left-hand on the back of the card. Most part numbers are marked with the sales order number. A custom part number is required to omit all marking from the card. Contact your local support representative for details.

³ The Printed card number is placed in the bottom right-hand corner for UHF.

⁵ Number of bits should remain below 120 bits.

* The composite construction is recommended for all cards with over-laminate applied. Consult with the printer manufacturer prior to ordering.

HID Proximity Credentials

ProxCard II Card - 1326

Ensure each required option has been checked with the appropriate choice to fulfill a completed order form.

1326 Base Model

125 kHz Programming (select one option)

- L** - Programmed with HID or Indala format
- N** - HID Prox unprogrammed, for use with iCLASS SE Encoder

Front Packaging (select one option)

- S** - ProxCard II Artwork - Vinyl with Matte Finish
- M** - Plain White Vinyl with Matte Finish
- G** - Plain White PVC with Gloss Finish
- C** - Custom Artwork - Specify Custom Artwork Number¹

Back Packaging (select one option)

- S** - Base with Molded HID Logo
- C** - Custom Artwork - Specify Custom Artwork Number¹

Card Numbering² (select one option)

- M** - Sequential Matching Encoded/Printed (Inkjetted)³
- N** - No Printed Card Numbering
- S** - Sequential Encoded/Sequential Non-Matching Printed (Inkjetted)³
- R** - Random Encoded/Non-Matching Sequential Printed (Inkjetted)³

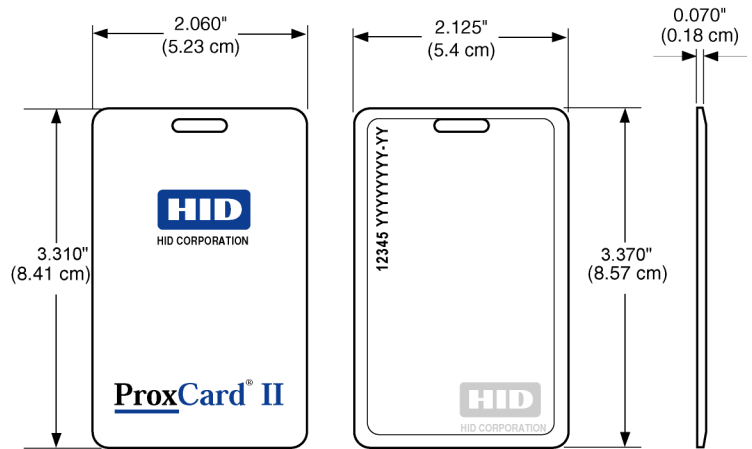

12345 = Card ID Number
YYYYYYYY-YY = Sales Order Number

Slot Punch

- V** - Vertical Slot Punch

Option - Custom Artwork²

_____ (Specify Artwork Number - Refer to the Custom Artwork Forms for new Artwork)

Enter your final card options from check boxes above. Example: 1326LSSMV

Final Part Number	1326					V	-	(Options #)
-------------------	------	--	--	--	--	---	---	-------------

125 kHz Card Programming Information

Format Number	Field Name(s) e.g. Facility Code	Value	QTY	Encoded Start Number	Encoded Stop Number
				Printed Start Number	Printed Stop Number

¹ For new artwork files, contact Customer Service for custom artwork number, lead-times, and cost.
² The Printed card number is placed in the top left-hand corner on the back of the card. The HID logo molded into the base on the back of the card. Most of part numbers are marked with the sales order number. A custom part number is required to omit all marking from the card. Contact your local support representative for details.
³ Please note that cards shipped within the Americas are always laser-engraved. Inkjetted option is not available for these cards.



- ¹ For new artwork files, contact Customer Service for custom artwork number, lead-times, and cost.
- ² Cards ordered with plain white front and back packaging, with no HID artwork or with custom artwork, will still have a small HID logo  and reference number printed in the lower left-hand corner and a slot punch target printed on the back of the card. Most part numbers are marked with the sales order number. A custom part number is required to omit all marking from the card. Contact your local support representative for details.
- ³ The Printed card number is placed in the bottom right-hand corner on the back of the card.
- ⁴ Cards are provided with an optional slot punch at no additional charge. Some video imaging printers cannot accommodate pre-slot punched cards. Consult with the printer manufacturer prior to ordering.
- ⁵ Please note that cards shipped within the Americas are always laser-engraved. Inkjetted option is not available for these cards.
- ⁶ Programmed as a sequential 12 digit number.
- * The composite construction is recommended for all cards that will have an over-laminate applied.

ProxKey III Keyfob - 1346

Ensure each required option has been checked with the appropriate choice to fulfill a completed order form.

1346 Base Model

Programming (select one option)

- L** - Programmed with HID Prox or Indala format
- N** - Unprogrammed HID Prox, for use with iCLASS SE Encoder

Front Packaging

- N** - ProxKey III - Black with grey insert. Includes HID Standard Artwork
- C** - ProxKey III - Custom Artwork - Specify Custom Artwork Number¹

Back Packaging

- S** - Standard

Keyfob Numbering² (select one option)

- M** - Sequential Matching Encoded/Printed (Inkjetted)³
- N** - No Printed Card Numbering
- S** - Sequential Encoded/Sequential Non-Matching Printed (Inkjetted)³
- R** - Random Encoded/Non-Matching Sequential Printed (Inkjetted)³
- A** - Sequential Matching Encoded/Printed (Engraved)
- B** - Sequential Encoded/Sequential Non-Matching Printed (Engraved)
- C** - Random Encoded/Non-Matching Sequential Printed (Engraved)

Additional Options⁴

- N** - No Option

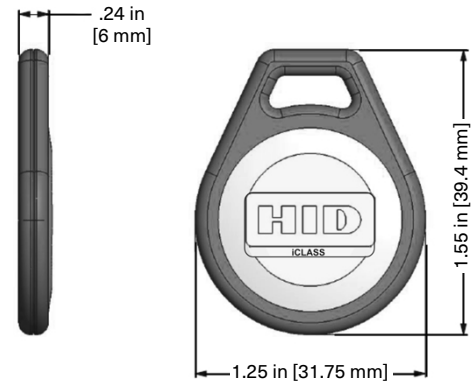

Y = iCLASS Programming
12345 = Card ID Number
YYYYYYYYYY = Sales Order Number

Enter your final ProxKey® options from check boxes above. Example: 1346LNSMN

Final Part Number	1346			S		N
-------------------	------	--	--	---	--	---

125 kHz ProxKey Programming Information

Format Number	Field Name(s) e.g. Facility Code	Value	QTY	Encoded Start Number	Encoded Stop Number
				Printed Start Number	Printed Stop Number

¹ For new artwork files, contact Customer Service for custom artwork number, lead-times, and cost.

² The Printed number is placed on the back of the Keyfob.

³ Please note that cards shipped within the Americas are always laser-engraved. Inkjetted option is not available for these cards.

⁴ Key Ring sold separately (Part Number: 57-0001-02).

ISOProx II Card - 1386 / 1586

Ensure each required option has been checked with the appropriate choice to fulfill a completed order form.

Base Model **1386 Standard PVC** **1586 Composite 40% Polyester / PVC***

125 kHz Programming (select one option)

- L** - Programmed with HID Prox or Indala format
- N** - Unprogrammed HID Prox, for use with iCLASS SE Encoder

Front Packaging (select one option)

- G** - Plain White PVC w/ Gloss Finish
- C** - Custom Artwork w/ Gloss Finish - Specify Custom Artwork Number¹

Back Packaging (select one option)

- G** - Plain White PVC w/ Gloss Finish²
- C** - Custom Artwork w/ Gloss Finish - Specify Custom Artwork Number^{1,2}

Card Numbering (select one option)

- M** - Sequential Matching Encoded/Printed (Inkjetted)⁵
- N** - No Printed Card Numbering
- S** - Sequential Encoded/Sequential Non-Matching Printed (Inkjetted)⁵
- R** - Random Encoded/Non-Matching Sequential Printed (Inkjetted)⁵
- A** - Sequential Matching Encoded/Printed (Engraved)
- B** - Sequential Encoded/Sequential Non-Matching Printed (Engraved)
- C** - Random Encoded/Non-Matching Sequential Printed (Engraved)

Slot Punch⁴ (select one option)

- N** - No slot punch, Printed Vertical and Horizontal Slot Indicators
- V** - Vertical Slot Punch, Printed Horizontal Slot Indicators
- H** - Horizontal Slot Punch, Printed Vertical Slot Indicators

Option - Custom Artwork¹

- _____ (Specify Artwork Number - Refer to the Custom Artwork Forms for new Artwork)

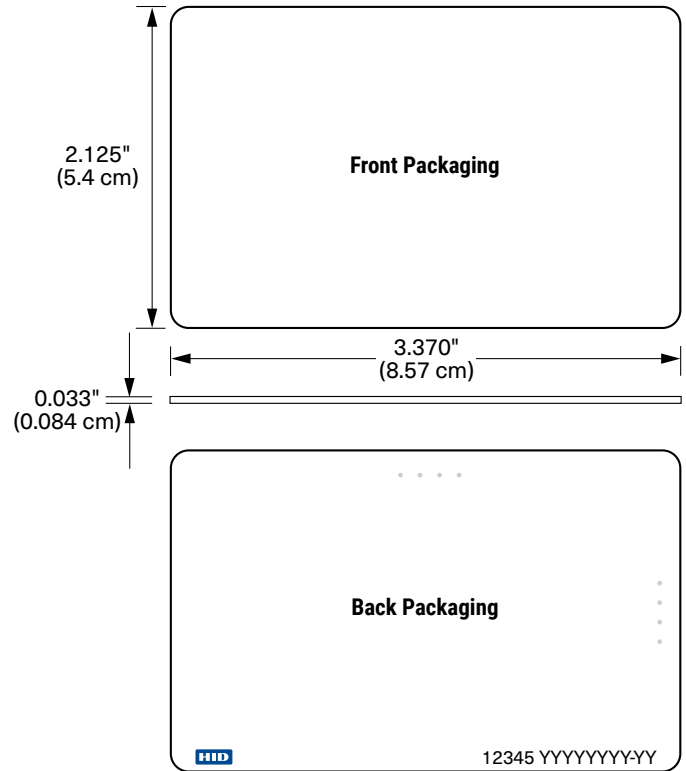

12345 = Card ID Number
YYYYYYYYYY = Sales Order Number

Enter your final card options from check boxes above. Example: 1386LGGMN

Final Part Number							-	(Options #)
-------------------	--	--	--	--	--	--	---	-------------

125 kHz Card Programming Information

Format Number	Field Name(s) e.g. Facility Code	Value	QTY	Encoded Start Number	Encoded Stop Number
				Printed Start Number	Printed Stop Number

¹ For new artwork files, contact Customer Service for custom artwork number, lead-times, and cost.

² Cards ordered with plain white front and back packaging, with no HID artwork or with custom artwork, will still have a small "HID logo" and reference number printed in the lower left-hand corner and a slot punch target printed on the back of the card. Most part numbers are marked with the sales order number. A custom part number is required to omit all marking from the card. Contact your local support representative for details.

³ The Printed card number is placed in the bottom right-hand corner on the back of the card.

⁴ Cards are provided with an optional slot punch at no additional charge. Some video imaging printers cannot accommodate pre-slot punched cards. Consult with the printer manufacturer prior to ordering.

⁵ Please note that cards shipped within the Americas are always laser-engraved. Inkjetted option is not available for these cards.

* The composite construction is recommended for all cards that will have an over-laminate applied.

ProxPass II Active Vehicle Identification Tag - 1351

(Compatible with MaxiProx® 5375)

Ensure each required option has been checked with the appropriate choice to fulfill a completed order form.

1351 Base Model

Programming¹

L - Programmed with HID Prox format

Color

B - Standard beige finish

Back Packaging

S - Standard HID logo

Tag Numbering (select one option)

- M - Sequential Matching Encoded/Printed (Inkjetted)
- N - No Printed Card Numbering
- S - Sequential Encoded/Sequential Non-Matching Printed (Inkjetted)
- R - Random Encoded/Non-Matching Sequential Printed (Inkjetted)

Hardware Option

N - None

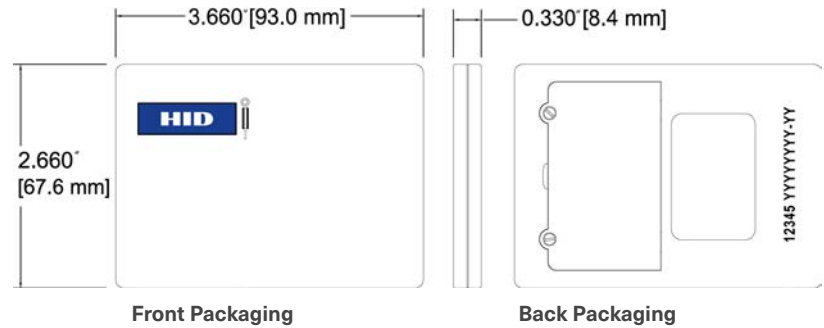

12345 = Card ID Number
YYYYYYYY-YY = Sales Order Number

Enter your final Tag options from check boxes above. Example: 1351LBSMN

Final Part Number	1351	L	B	S		N	-	(Optional Artwork #)
-------------------	------	---	---	---	--	---	---	----------------------

125 kHz Tag Programming Information¹

Format Number	Field Name(s) e.g. Facility Code	Value	QTY	Encoded Start Number	Encoded Stop Number
				Printed Start Number	Printed Stop Number

¹ The ProxPass II does not support formats longer than 37-bits (including 48-bit Corporate 1000).

The ProxPass II Tag includes two replaceable Encoded batteries and Velcro strips for a complete and simple installation.

Battery Part # BR2330 is available at most electronic stores (not sold by HID).

MicroProx Tag Proximity - 1391

Ensure each required option has been checked with the appropriate choice to fulfill a completed order form.

1391 Base Model

Programming (select one option)

- L - Programmed with HID Prox or Indala format
- N - Unprogrammed HID Prox for use with iCLASS SE Encoder

Front Packaging (select one option)

- S - Gray with HID Standard Artwork
- G - Plain Gray Finish, (No Artwork)
- C - Custom Artwork - Specify Custom Artwork Number¹

Back Packaging³

- S - Adhesive Backing

Tag Numbering² (select one option)

- M - Sequential Matching Encoded/Printed (Inkjetted)³
- N - No Printed Tag Numbering
- S - Sequential Encoded/Sequential Non-Matching Printed (Inkjetted)³
- R - Random Encoded/Non-Matching Sequential Printed (Inkjetted)³

Slot Punch

- N - None

Optional Custom Artwork¹

- _____ (Specify Artwork Number - Refer to the Custom Artwork Forms for new Artwork)

Enter your final Tag options from check boxes above. Example: 1391LSSMN

Final Part Number	1391				S		N	-	(Options #)
-------------------	------	--	--	--	---	--	---	---	-------------

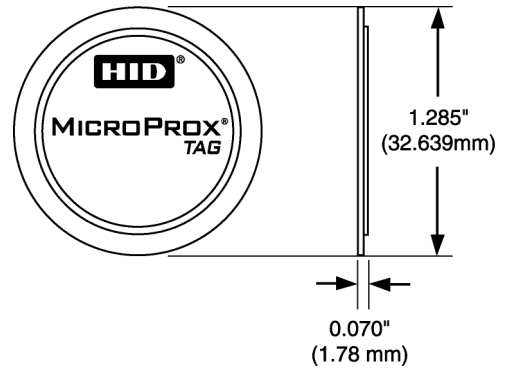

125 kHz Tag Programming Information

Format Number	Field Name(s) e.g. Facility Code	Value	QTY	Encoded Start Number	Encoded Stop Number
				Printed Start Number	Printed Stop Number

¹ For new artwork files, contact Customer Service for custom artwork number, lead-times, minimum order quantities, and cost.

² The Printed tag number is placed on the back of the tag. In order to support laser marking technology HID will be transitioning from a white release paper to a black release paper. Please consult your sales Account Manager for more information.

³ Please note that cards shipped within the Americas are always laser-engraved. Inkjetted option is not available for these cards.

The MicroProx Tag is not for use on cards that use full insertion or tractor feed type readers.

Do not adhere to metal surfaces. Metal shields the RF, making the tag inoperable. Due to variations in cards and reading devices, HID does not claim that the MicroProx Tag will work in every situation. Functional and non-functional MicroProx Tags are available for compatibility testing with existing credential and reader technologies. Compatibility should be confirmed prior to ordering.

MicroProx Placement

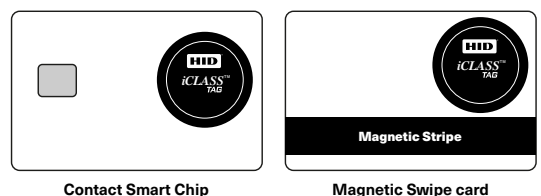



Direct Image PVC Glossy Label Part Numbers

Part #	Description	Thickness	Dimensions
1324GAV11	ProxCard II size with slot punch, white adhesive back	10 mil PVC	3.310" x 2.060"
1324GAN11	ProxCard II size, no slot punch, white adhesive back	10 mil PVC	3.310" x 2.060"
1324GAV21	ProxCard II size with slot punch, white adhesive back	20 mil PVC	3.310" x 2.060"
1324GAN21	ProxCard II size, no slot punch, white adhesive back	20 mil PVC	3.310" x 2.060"
1324GBV22	ISOProx II and ProxCard II size with slot punch, brown (3M) adhesive back	20 mil PVC	3.370" x 2.125"
1324GBN22	ISOProx II and ProxCard II size, no slot punch, brown (3M) adhesive back	20 mil PVC	3.370" x 2.125"
1324GAV22	ISOProx II and ProxCard II size, with slot punch, white adhesive back	20 mil PVC	3.370" x 2.125"
1324GAN22	ISOProx II and ProxCard II size, no slot punch, white adhesive back	20 mil PVC	3.370" x 2.125"

Notes:

- Some dye sublimation printers cannot accommodate pre-slot punched labels; consult with the printer manufacturer prior to ordering.
- Labels are packaged in multiples of 100 pieces. Minimum order quantity is 100 pieces. Orders will be accepted in multiples of 100 pieces per label Model.
- Make sure to adjust your dye sublimation printer setting to the proper PVC label thickness and dimension.



Indala 125 kHz Credential

Every part number consists of a base model number to indicate the type of product, and a letter or number to indicate each product option. Each Indala product has a standard part number that includes default options, as indicated on the order guide. When an order is placed for a product, the base model number and all options must be specified. If you require any options that are different from the default options, you must also indicate those options at the time the order is placed. All part numbers must be complete to be accepted by HID's order entry system.

All card orders must have the following information:

- **BASE MODEL NUMBER** - Specifies card or type.
- **PROGRAMMING** - Specifies if card is factory or field programmed
(**format or format number, facility code, and ID number range must be given at time of order**).
- **FRONT** or **FLAT SIDE GRAPHICS** - Specifies standard or custom artwork, and smart chip placement.
- **BACK** or **EMBOSSED SIDE GRAPHICS** - Specifies standard or custom artwork, and smart chip placement.
- **MARKING POSITION** - Specifies location of card marking.

Note: Card marking is surface printed and, therefore is not to be considered permanent. In certain cases Laser etching may be used instead of inkjet marking. Laser etching is permanent marking but is not used on all products.

- **SLOT PUNCH** - Specifies slot location if available.
- **CARD OPTIONS** - Applies to FlexCard™ (Base Model FPCRD/CXCRD) only.
- **MAGNETIC STRIPE OPTION** - Specifies if card is to have a magstripe and which type (ISO Imageable Cards only).
- **CUSTOM FILE NUMBER** - Specifies the artwork number to be used.

FPISO - FlexPass Imageable Card

Standard Part No.: FPISO-SSSCNA-0000

Description: 125 kHz, white glossy finish front, white glossy finish with Indala logo back, marking on standard location, no slot punch, no magstripe, no artwork.

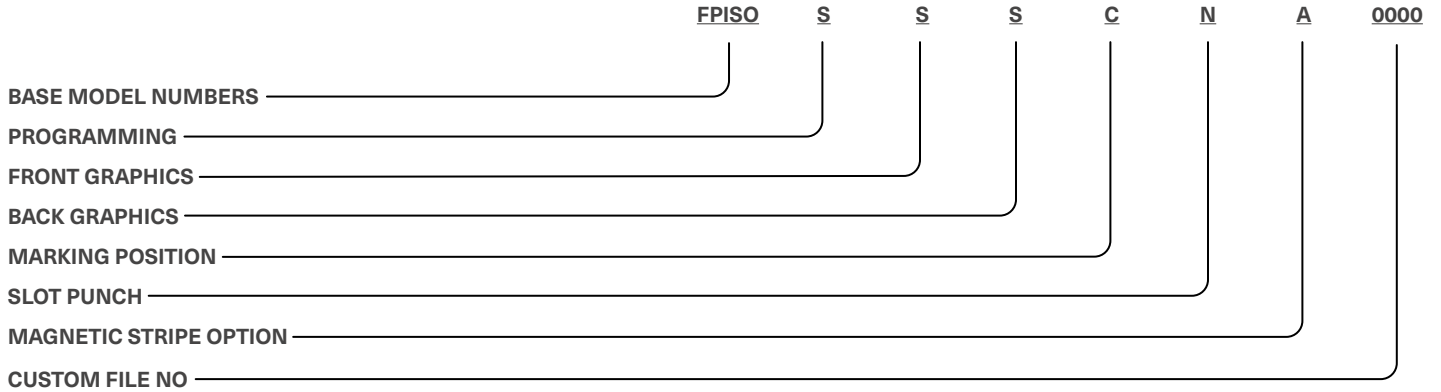

BASE MODEL NUMBERS

- FPISO** FlexISO Proximity Card
- FPWGD** FlexISO Proximity and Wiegand Combination Card
- FPIXT** FlexISO XT Composite Proximity Card

PROGRAMMING

- S** = Standard, Programmed, Low Frequency 125 kHz - exact coding standard, with no gaps or over-runs
(Specify Format Number, Facility Code, and ID Range)
- N** = Not Programmed, Low Frequency 125 kHz (Blank/Programmable)

FRONT GRAPHICS

- S** = Standard white glossy finish, suitable for video imaging
- C** = Custom (Artwork on file or new)

BACK GRAPHICS

- S** = Standard white glossy finish with Indala logo, card marking (Sales Order & matching internal ID number), suitable for dye sublimation imaging in most areas
- C** = Custom (Artwork on file or new)

MARKING POSITION

Note: Standard Marking is Label Code E153, which is Sales Order number & matching 5 digit internal ID number, is used unless otherwise specified.

C = Position 3/Standard Location (Back Side/Lower Right Corner)

Note: Inkjet marking is surface printed and, therefore is not to be considered permanent. In some cases Laser etching will replace inkjet marking. Laser etching is permanent in most applications.

SLOT PUNCH

- N** = None
- V** = Vertical (portrait orientation) - Unavailable for FPWGD
- H** = Horizontal (landscape orientation)

MAGNETIC STRIPE OPTION

- A** = No Magstripe
- B** = Standard Magstripe (3-track, high coercivity, 4000 oersted)

CUSTOM FILE NUMBER (4 Characters - Factory Assigned)

0000 = No Artwork (Call your Customer Service Representative for new artwork)

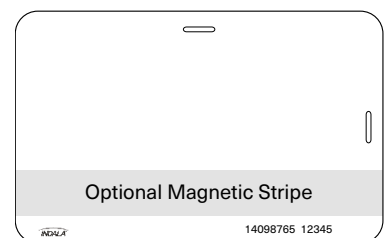

Position C

FPCRD - FlexCard Standard Card

Standard Part No.: FPCRD-SSSMW-0000

Description: 125 kHz, printed Indala logo on front, embossed Indala logo on back, card marking on flat side (lower right corner with slot to the right), white color (not printable), no artwork. Vertical slot punch only.

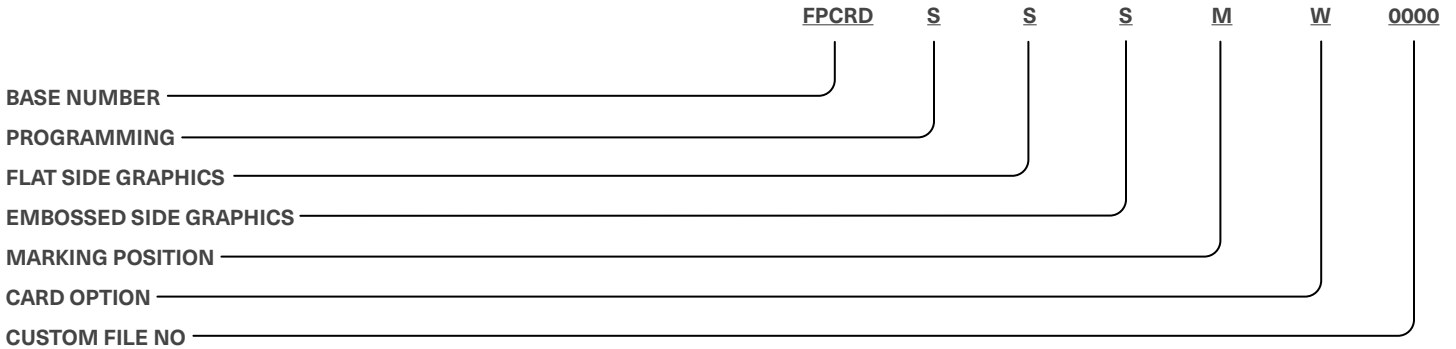

BASE NUMBER

FPCRD - 125 kHz Clamshell type Proximity Card

PROGRAMMING

S = Standard, Programmed, Low Frequency 125 kHz - exact coding standard, with no gaps or over-runs
(Specify Format or Format Number, Facility Code, and ID Range)

N = Not Programmed, Low Frequency 125 kHz (Blank/Programmable)

FLAT SIDE GRAPHICS

S = Standard (Flat Side with printed Indala logo)

C = Custom (Artwork on file or new)

EMBOSSED SIDE GRAPHICS

S = Standard (Embossed Side with embossed Indala logo)

C = Custom (Artwork on file or new, still with embossed Indala logo)

MARKING POSITION

Notes:

- Standard Marking or Label Code E153, which is Sales Order number & matching internal ID number, is used unless otherwise specified.
- Inkjet marking is surface printed and, therefore is not to be considered permanent. In some cases Laser etching will replace inkjet marking. Laser etching is permanent in most applications.

A = Position 1/Flat Side (with slot punch to the right, lower left corner) - available with Printable Option only

C = Position 3/Flat Side (with slot punch to the right, lower right corner) - available with Printable Option only

K = Position 1/Embossed Side (with slot punch to the right, lower left corner)

M = (Standard) = Position 3/Embossed Side (with slot punch to the right, lower right corner)

CARD OPTION

W = White (standard color) - surface treated with UV protection - may not accept printing

P = Printable, matt finish - No varnish, no logo, surface will accept post printing

CUSTOM FILE NUMBER (4 Characters - Factory Assigned)

0000 = No Artwork

Call your Customer Service Representative for new artwork

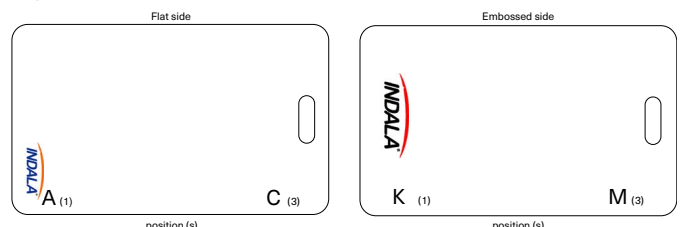

FPTAG - FlexTag

Standard Part No.: FPTAG-SSSS-XXXX

Description: 125 kHz, printed Indala logo on front side.

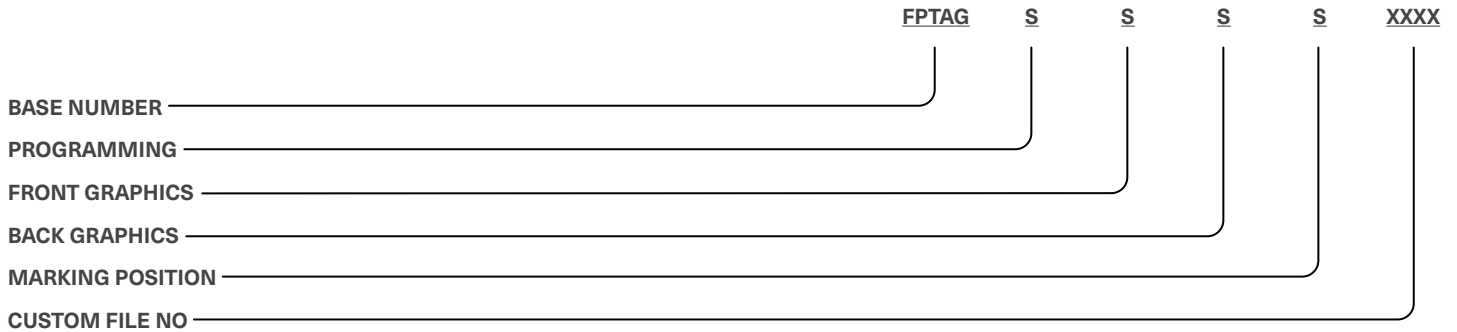

BASE NUMBER

FPTAG - 125 kHz Keytag Type Proximity Card

PROGRAMMING

S = Standard Programmed, Low Frequency 125 kHz - exact coding standard, with no gaps or over-runs.

(Specify Format or Format Number, Facility Code, and ID Range)

N = Not Programmed

FRONT GRAPHICS

S = Standard (printed Indala logo)

BACK GRAPHICS

S = Standard (no logo, printed strip for marking)

MARKING POSITION

Notes:

- Standard Marking or Label Code E201, which is a shortened version of the Sales Order number & matching internal ID number, is used unless otherwise specified.
- Inkjet marking is surface printed and, therefore is not to be considered permanent. Most Keytag marking will be with Laser etching which is permanent in most applications.

S = Standard (back side on printed strip)

CUSTOM FILE NUMBER XXXX (4 Characters - Factory Assigned)

0002 = No Artwork

AAAA = Custom Artwork. Contact your Customer Service Representative for new artwork.

In order to support laser marking technology HID will be transitioning from a white release paper to a black release paper. Please consult your sales Account Manager for more information.

FPKEY - FlexKey Keytag

Standard Part No.: FPKEY-SSSS-0000

Description: 125 kHz, printed Indala logo on front side, printed strip for marking on back side.

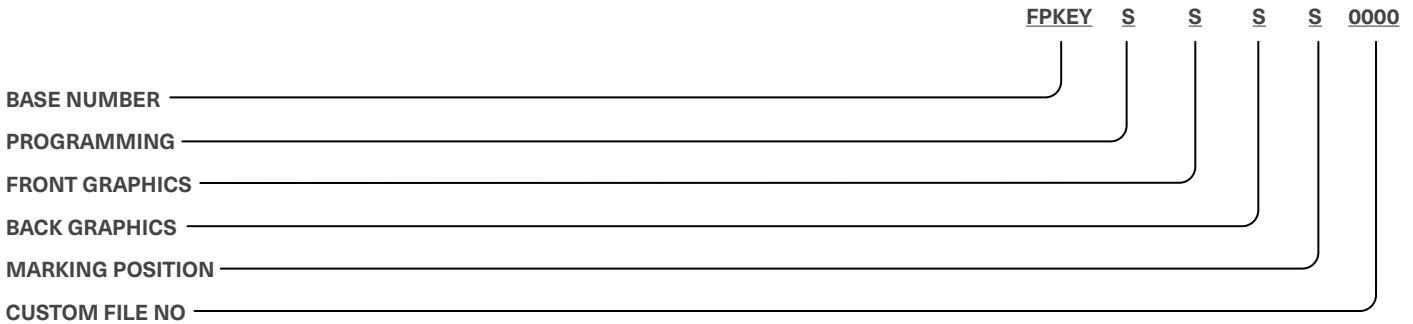

BASE NUMBER

FPKEY - 125 kHz Keytag Type Proximity Card

PROGRAMMING

S = Standard, Programmed, Low Frequency 125 kHz - exact coding standard, with no gaps or over-runs
(Specify Format or Format Number, Facility Code, and ID Range)

N = Not Programmed, Low Frequency 125 kHz (Blank/Programmable)

FRONT GRAPHICS

S = Standard (printed Indala logo)

C = Custom (Artwork on file or new)

BACK GRAPHICS

S = Standard (no logo, printed strip for marking)

C = Custom (Artwork on file or new)

MARKING POSITION

Notes:

- Standard Marking or Label Code E201, which is a shortened version of the Sales Order number & matching internal ID number, is used unless otherwise specified.
- Inkjet marking is surface printed and, therefore is not to be considered permanent. Most Keytag marking will be with Laser etching which is permanent in most applications.

S = Standard (back side on printed strip)

CUSTOM FILE NUMBER (4 Characters - Factory Assigned)

0000 = No Artwork

Call your Customer Service Representative for new artwork.

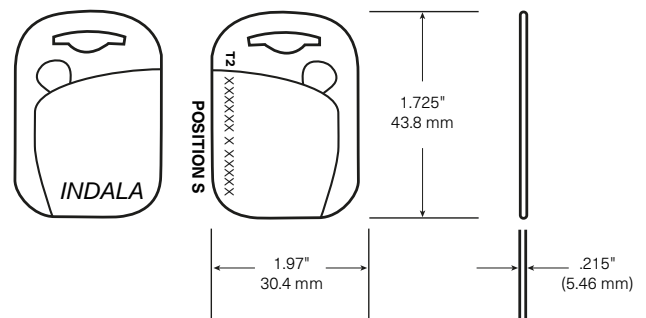



FlexPass Formats

The following formats are non-proprietary and are available to all customers.

Format Name: 26-BIT WIEGAND

Card Format Number

40134
ASP 10022

Facility Code Range

0 to 255
0 to 255

ID Number Range

0 to 65,535 (Systems installed prior to June 2003)
0 to 65,535 (All new Systems except FP Lite)

Reader Format Numbers

10022 (1L = 1x Wire for LED control)
10200 (2L = 2x Wires for LED control)

Format Name: 27-BIT INDALA

Card Format Number

4010X

Facility Code Range

0 to 8,191

ID Number Range

0 to 16,383

Reader Format Numbers

10251 (1L = 1x Wire for LED control)
1026X (2L = 2x Wires for LED control)

Format Name: ABA TRACK 2

Card Format Numbers

4038X (ASP)
17256 (ASP+)

Facility Code Range

0 to 255
0 to 99,999

ID Number Range

0 to 99,999
0 to 99,999

Reader Format Numbers

11037 OC (Open Collector)
11738 PUR (Pull Up Resistor)

Format Name: RS232 Serial Data

Card Format Number

16144

Card Programming Range

up to 24 characters in total length, i.e. ABCD12345678901234567890

Reader Format Number

16144

Format Options for FP506B/FP507B Proximity & Keypad Readers (e.g. Format 10022K01)

CFG. Number	Buf/Unbuf	Data Type	Options	Pin Size	Special Keys	Emulates
K01	UnBuffered	8-bit burst			*/# keys enabled	ARK-501
K02	UnBuffered	8-bit burst			*/# keys disabled	
K03	Buffered	Wiegand	facility code xx		*/# keys enabled	
K04	Buffered	Wiegand	facility code xx		*/# keys disabled	
K05	Buffered	Magstripe	LSB First	4 digit PIN	*/# keys enabled	ARK-501 BUFFERED
K06	Buffered	Magstripe	LSB First	4 digit PIN	*/# keys disabled	ARK-501 BUFFERED PINKERTON
K07	Buffered	Magstripe	LSB First	5 digit PIN	*/# keys enabled	
K08	Buffered	Magstripe	LSB First	5 digit PIN	*/# keys disabled	
K09	Buffered	Magstripe	MSB First	4 digit PIN	*/# keys enabled	
K10	Buffered	Magstripe	MSB First	4 digit PIN	*/# keys disabled	
K11	Buffered	Magstripe	MSB First	5 digit PIN	*/# keys enabled	
K12	Buffered	Magstripe	MSB First	5 digit PIN	*/# keys disabled	
K13	Unbuffered	4 bit burst			*/# keys enabled	
K14	Unbuffered	4 bit burst			*/# keys disabled	



MIFARE DESFire® Credentials

HID Global DESFire EV3 credentials are available with a range of programming profiles to meet high security requirements using the Secure Identity Object™ (SIO), offer compatibility with existing EV1 based infrastructure or meet custom specifications. There are three core programming profiles:

- **High Security Profile**

A Secure Identity Object (SIO) based DESFire EV3 application that utilizes the latest security features combined with random UID for enhanced privacy protection. Compatible with HID Signo™ Reader firmware 10.0.2.4 or higher.

- **Compatibility Profile**

Offers the flexibility of backwards compatibility with iCLASS SE® readers and third party readers that rely on static UID through the introduction of an additional legacy EV1 Secure Identity Object (SIO) application. Based on static UID for compatibility.

This option includes:

- Legacy EV1 SIO Application
 - Compatibility: Supported by HID Signo, iCLASS SE and multiCLASS SE readers
- EV3 SIO Application
 - Compatibility: Supported by HID Signo readers with firmware 10.0.2.4 or higher.

- **Custom Profile**

Available programmed to meet custom specifications, or unprogrammed for full in-field personalization compatible with EV1, EV2, or EV3 compliant solutions.

	Base Part Number				DESFire Compatibility	
	Mifare DESFire EV3	Mifare DESFire EV3 + Prox	Mifare DESFire EV3 + iCLASS	Mifare DESFire EV3 + iCLASS + Prox	Readers	CP1000
High Security Profile	802	812	822	832	Signo Reader (firmware 10.0.2.4 or greater)	Custom Application Programming with Non-Diversified keys
Compatibility Profile	801	811	821	831	Signo Reader, iCLASS SE, multiCLASS SE	EV1 SIO and Custom Application Programming
Custom Profile	800	810	820	830	iCLASS SE "W" Custom Profile, multiCLASS SE "W" Custom Profile	EV1 Custom Application Programming

MIFARE DESFire EV3 Card: High Security Profile – 802

Advanced security and privacy, programmed with an enhanced Secure Identity Object (SIO) based application that leverages new features of EV3. Introduces Random UID support to ensure privacy of user data.

EV3 SIO Application Compatibility: Supported by HID Signo readers with firmware 10.0.2.4 or higher.

Ensure each required option has been checked with the appropriate choice to fulfill a completed order form.

Base Model **802 Composite (40% Polyester/PVC)**

MIFARE DESFire EV3 Memory Size

F - 8K Bytes

Secure Identity Object Programming¹

P - Programmed with EV3 Secure Identity Object (SIO) application.
Based on Random UID for improved privacy of user data.

Front Packaging (select one option)

- G - Plain White with Gloss Finish**
- C - Custom Artwork with Gloss Finish – Specify Custom Artwork Number³**

Back Packaging (select one option)

- G - Plain White with Gloss Finish²**
- 1 - Plain White with Gloss Finish with Magnetic Stripe²**
- C - Custom Artwork with Gloss Finish – Specify Custom Artwork Number^{2,3}**
- 3 - Custom Artwork with Gloss Finish with Magnetic Stripe – Specify Custom Artwork Number^{2,3}**

Card Numbering⁴ (select one option)

- N - No Printed Card Numbering, sales number marking only**
- A - Sequential Matching Encoded/Printed (Laser Engraved)**
- B - Sequential Encoded/Sequential Non-Matching Printed (Laser Engraved)**
- C - Random Encoded/Non-Matching Sequential Printed (Laser Engraved)**

Slot Punch

N - No Slot Punch.

IMPORTANT: 802 credentials do not allow a slot punch due to antenna design. Use a badge holder to attach this card to a lanyard or badge clip.

Option - Custom Artwork¹

_____ (Specify Artwork Number - Refer to the Custom Artwork Forms for new Artwork)

Enter your final card options from check boxes above. Example: 802FPPGGAN

Final Part Number	802	F	P				N	-	(Options #)
-------------------	-----	---	---	--	--	--	---	---	-------------

DESFire EV3 Card Programming Information

Format Number	Field Name(s) e.g. Facility Code	Value	QTY	Encoded Start Number	Encoded Stop Number
HID Elite ICE				Printed Start Number	Printed Stop Number

¹ Third party applications are required to support random UID, if in doubt, consult with the application vendor. Card allows free create/delete of third party applications.

² Cards ordered with plain white front and back packaging, with no HID artwork or with custom artwork, will still have a small “HID logo”  and reference number printed in the lower left-hand corner on the back of the card. A custom part number is required to omit all marking.

³ For new artwork files, contact Customer Service for custom artwork number, lead-times, and cost.

⁴ The printed card number is placed in the bottom right-hand corner on the back of the card.

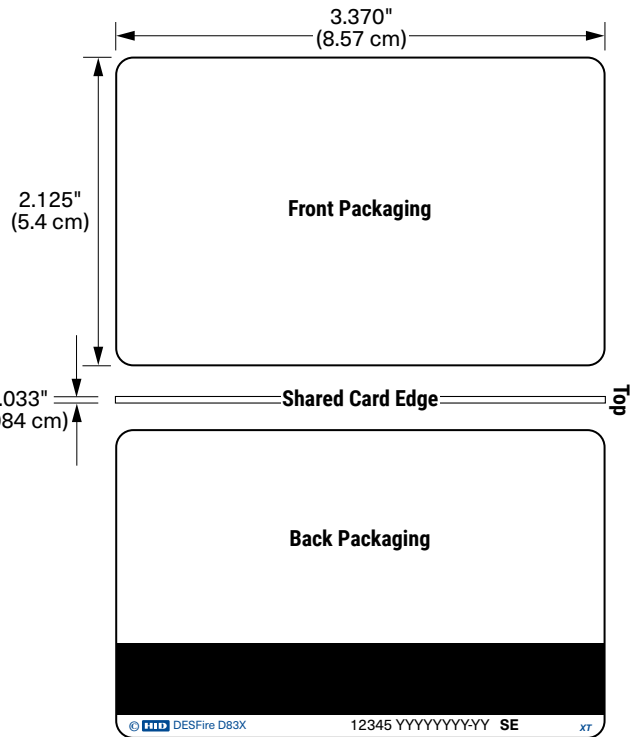

12345 = Card ID Number
YYYYYYY-YY = Sales Order Number

MIFARE DESFire EV3 Card: Compatibility Profile – 801

Offers the flexibility of backwards compatibility with iCLASS SE readers and third party readers that rely on static UID through the introduction of an additional legacy EV1 Secure Identity Object (SIO) application. Based on static UID for compatibility.

Legacy EV1 SIO Application Compatibility: Supported by HID Signo, iCLASS SE and multiCLASS SE readers.

EV3 SIO Application Compatibility: Supported by HID Signo readers with firmware 10.0.2.4 or higher.

Ensure each required option has been checked with the appropriate choice to fulfill a completed order form.

Base Model **801 Composite (40% Polyester/PVC)**

MIFARE DESFire EV3 Memory Size

F - 8K Bytes

DESFire Secure Identity Object Programming¹

- P - Programmed with legacy EV1 Secure Identity Object (SIO) application **plus** EV3 Secure Identity Object (SIO) application
- V - Unprogrammed for use with iCLASS SE Encoder (EV1 compatible SIO application programming only)

Front Packaging (select one option)

- G - Plain White with Gloss Finish
- C - Custom Artwork with Gloss Finish – Specify Custom Artwork Number³

Back Packaging (select one option)

- G - Plain White with Gloss Finish²
- 1 - Plain White with Gloss Finish with Magnetic Stripe²
- C - Custom Artwork with Gloss Finish – Specify Custom Artwork Number^{2,3}
- 3 - Custom Artwork with Gloss Finish with Magnetic Stripe – Specify Custom Artwork Number^{2,3}

Card Numbering⁴ (select one option)

- N - No Printed Card Numbering, sales number marking only
- A - Sequential Matching Encoded/Printed (Laser Engraved)
- B - Sequential Encoded/Sequential Non-Matching Printed (Laser Engraved)
- C - Random Encoded/Non-Matching Sequential Printed (Laser Engraved)

Slot Punch

N - No Slot Punch.

IMPORTANT: 801 credentials do not allow a slot punch due to antenna design. Use a badge holder to attach this card to a lanyard or badge clip.

Option - Custom Artwork³

_____ Specify Artwork Number - Refer to the Custom Artwork Forms for new Artwork)

Enter your final card options from check boxes above. Example: 801FPGGAN

Final Part Number	801	F					N	-	(Options #)
-------------------	-----	---	--	--	--	--	---	---	-------------

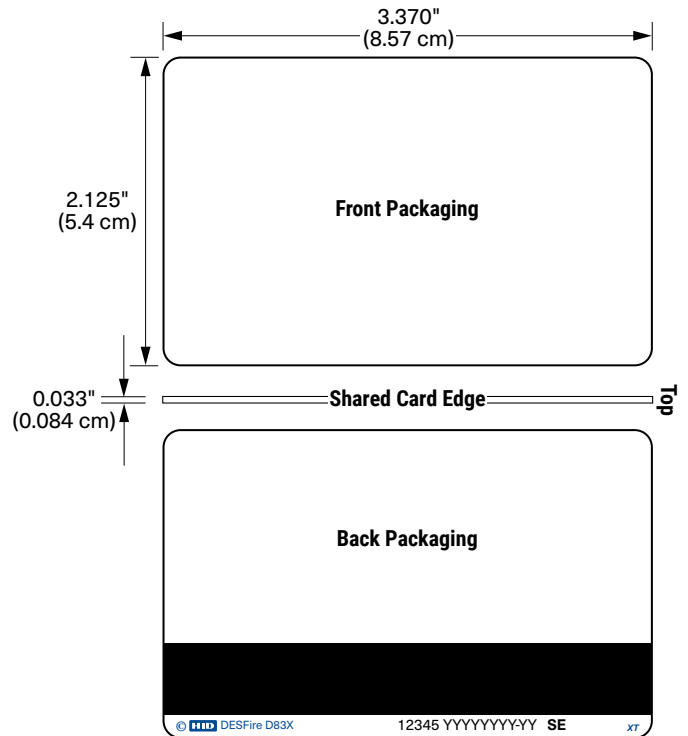

12345 = Card ID Number
YYYYYYY-YY = Sales Order Number



DESFire EV3 Card Programming Information

Format Number	Field Name(s) e.g. Facility Code	Value	QTY	Encoded Start Number	Encoded Stop Number
HID Elite ICE				Printed Start Number	Printed Stop Number

¹ Card allows free create/delete of third party applications.

² Cards ordered with plain white front and back packaging, with no HID artwork or with custom artwork, will still have a small "HID logo"  and reference number printed in the lower left-hand corner on the back of the card. A custom part number is required to omit all marking.

³ For new artwork files, contact Customer Service for custom artwork number, lead-times, and cost.

⁴ The printed card number is placed in the bottom right-hand corner on the back of the card.

MIFARE DESFire EV3 Card: Custom Profile - 800

Available customized for bespoke specifications, or unprogrammed for full in-field personalization compatible with EV1, EV2 or EV3 compliant solutions.

Compatibility: Supported by custom profile HID Signo, iCLASS SE and multiCLASS SE readers.

Ensure each required option has been checked with the appropriate choice to fulfill a completed order form.

Base Model

800 Composite (40% Polyester/PVC)

MIFARE DESFire EV3 Memory Size

F - 8K Bytes

DESFire Programming (select one option)

- N** - Unprogrammed DESFire EV3 for use with iCLASS SE Encoder (EV1 custom encoding only) or third-party EV1, EV2 or EV3 applications
- S** - Custom MIFARE DESFire EV1, EV2 or EV3 programming, requires custom part number¹

Front Packaging (select one option)

- G** - Plain White with Gloss Finish²
- C** - Custom Artwork with Gloss Finish – Specify Custom Artwork Number³

Back Packaging (select one option)

- G** - Plain White with Gloss Finish²
- 1** - Plain White with Gloss Finish with Magnetic Stripe²
- C** - Custom Artwork with Gloss Finish – Specify Custom Artwork Number^{2,3}
- 3** - Custom Artwork with Gloss Finish with Magnetic Stripe – Specify Custom Artwork Number^{2,3}

Card Numbering⁴ (select one option)

- N** - No Printed Card Numbering, sales number marking only
- A** - Sequential Matching Encoded/Printed (Laser Engraved)
- B** - Sequential Encoded/Sequential Non-Matching Printed (Laser Engraved)
- C** - Random Encoded/Non-Matching Sequential Printed (Laser Engraved)
- Z** - Reversed UID (CSN) Decimal card numbering only(Laser Engraved)

Slot Punch

N - No Slot Punch.

IMPORTANT: 80 credentials do not allow a slot punch due to antenna design. Use a badge holder to attach this card to a lanyard or badge clip.

Option - Custom Artwork³

_____ (Specify Artwork Number - Refer to the Custom Artwork Forms for new Artwork)

Enter your final card options from check boxes above. Example: 800FNGN

Final Part Number	800	F					N	-	(Options #)
-------------------	-----	---	--	--	--	--	---	---	-------------

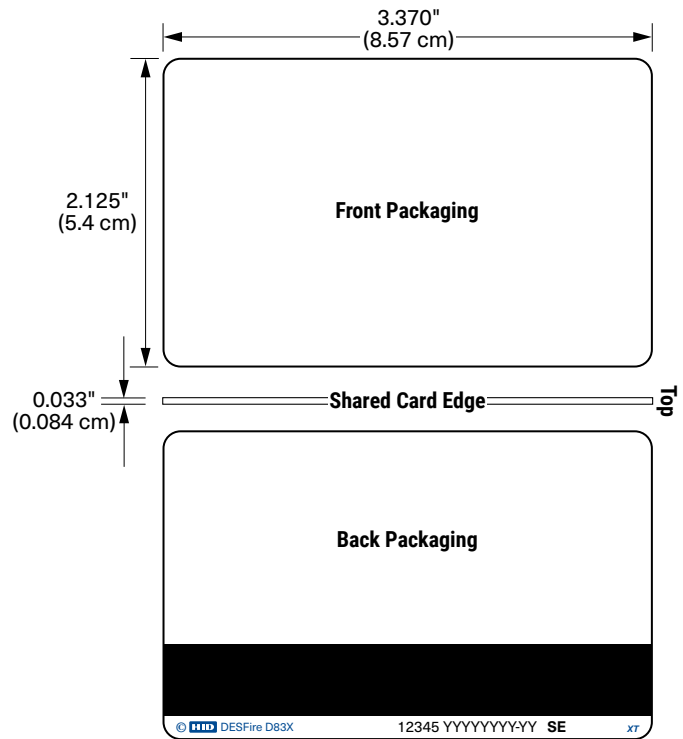

12345 = Card ID Number
YYYYYYY-YY = Sales Order Number



DESFire EV3 Card Programming Information

Format Number	Field Name(s) e.g. Facility Code	Value	QTY	Encoded Start Number	Encoded Stop Number
				Printed Start Number	Printed Stop Number

¹ Contact your local sales or pre-sales representative, HID requires a full written specification, additional lead time applies for setup, test, and evaluation of custom profiles.

² Cards ordered with plain white front and back packaging, with no HID artwork or with custom artwork, will still have a small "HID logo"  and reference number printed in the lower left-hand corner on the back of the card. A custom part number is required to omit all marking.

³ For new artwork files, contact Customer Service for custom artwork number, lead-times, and cost.

⁴ The Printed card number is placed in the bottom right-hand corner on the back of the card.

MIFARE DESFire EV3 + Prox Card: High Security Profile – 812

Migration solution from HID Proximity to enhanced security and privacy on EV3, programmed with an enhanced Secure Identity Object (SIO) based application that leverages new features of EV3. Introduces Random UID support to ensure privacy of user data.

EV3 SIO Application Compatibility: Supported by HID Signo readers with firmware 10.0.2.4 or higher.

Ensure each required option has been checked with the appropriate choice to fulfill a completed order form.

Base Model **812 Composite (40% Polyester/PVC)**

MIFARE DESFire EV3 Memory Size

F - 8K Bytes

DESFire Secure Identity Object Programming¹

P - Programmed with EV3 Secure Identity Object (SIO) application.
Based on Random UID for improved privacy of user data.

Prox Programming (select one option)

- P** - Programmed with HID Prox or Indala format
- N** - Unprogrammed HID Prox for iCLASS SE encoder (CP1000)

Front Packaging (select one option)

- G** - Plain White with Gloss Finish
- C** - Custom Artwork with Gloss Finish - Specify Custom Artwork Number³

Back Packaging (select one option)

- G** - Plain White with Gloss Finish²
- 1** - Plain White with Gloss Finish with Magnetic Stripe²
- C** - Custom Artwork with Gloss Finish - Specify Custom Artwork Number^{2,3}
- 3** - Custom Artwork with Gloss Finish with Magnetic Stripe - Specify Custom Artwork Number^{2,3}

DESFire Card Numbering⁴ (select one option)

- N** - No Printed Card Numbering
- A** - Sequential Matching Encoded/Printed (Laser Engraved)
- B** - Sequential Encoded/Sequential Non-Matching Printed (Laser Engraved)
- C** - Random Encoded/Non-Matching Sequential Printed (Laser Engraved)

Slot Punch

N - No Slot Punch.

IMPORTANT: 812 credentials do not allow a slot punch due to antenna design. Use a badge holder to attach this card to a lanyard or badge clip.

125 kHz Card Numbering⁴

- N** - No Printed Card Numbering
- A** - Sequential Matching Encoded/Printed (Laser Engraved)
- B** - Sequential Encoded/Sequential Non-Matching Printed (Laser Engraved)
- C** - Random Encoded/Non-Matching Sequential Printed (Laser Engraved)

Option - Custom Artwork³

_____ (Specify Artwork Number - Refer to the Custom Artwork Forms for new Artwork)

Enter your final card options from check boxes above. Example: 812FPPGGANA

Final Part Number	812	F	P				N	-	(Options #)
-------------------	-----	---	---	--	--	--	---	---	-------------

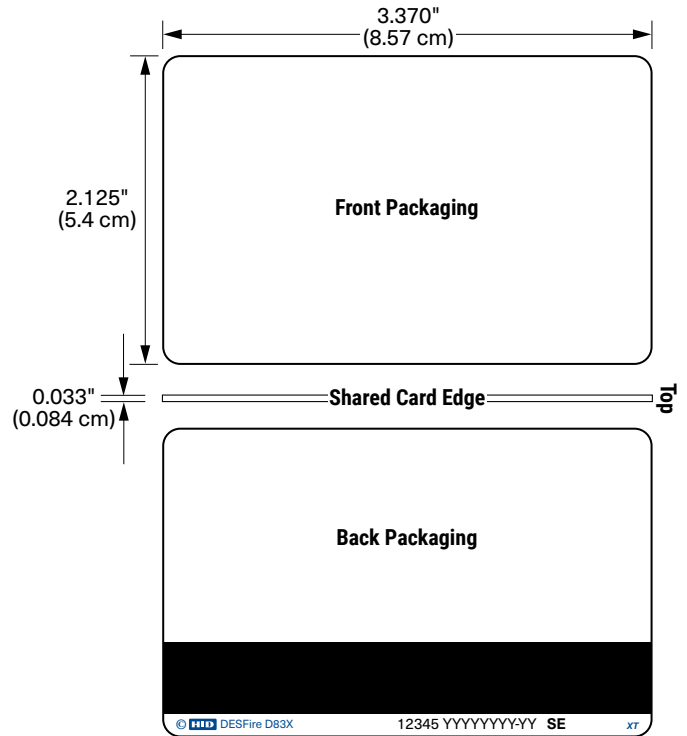

12345 = Card ID Number
YYYYYYY-YY = Sales Order Number



DESFire EV3 Card Programming Information

Format Number	Field Name(s) e.g. Facility Code	Value	QTY	Encoded Start Number	Encoded Stop Number
HID Elite ICE				Printed Start Number	Printed Stop Number

DESFire EV3 Card Programming Information

Format Number	Field Name(s) e.g. Facility Code	Value	QTY	Encoded Start Number	Encoded Stop Number
				Printed Start Number	Printed Stop Number

¹ Third party applications are required to support random UID, if in doubt, consult with the application vendor. Card allows free create/delete of third party applications.

² For new artwork files, contact Customer Service for custom artwork number, lead-times, and cost.

³ Cards ordered with plain white front and back packaging, with no HID artwork or with custom artwork, will still have a small "HID logo"  and reference number printed in the lower left-hand corner on the back of the card. A custom part number is required to omit all marking.

⁴ The Printed card number is placed in the bottom right-hand corner on the back of the card.

MIFARE DESFire EV3 + Prox Card: Compatibility Profile - 811

Migration solution from Proximity that offers the flexibility of backwards compatibility with iCLASS SE readers and third party readers that rely on static UID through the introduction of an additional legacy EV1 Secure Identity Object (SIO) application. Based on static UID for compatibility.

Legacy EV1 SIO Application Compatibility: Supported by HID Signo, iCLASS SE and multiCLASS SE readers.

EV3 SIO Application Compatibility: Supported by HID Signo readers with firmware 10.0.2.4 or higher.

Ensure each required option has been checked with the appropriate choice to fulfill a completed order form.

Base Model **811 Composite (40% Polyester/PVC)**

MIFARE DESFire EV3 Memory Size

F - 8K Bytes

DESFire Secure Identity Object Programming¹

- P** - Programmed with legacy EV1 Secure Identity Object (SIO) application **plus** EV3 Secure Identity Object (SIO) application.
- V** - Unprogrammed for use with iCLASS SE Encoder (EV1 compatible SIO application programming only)

Prox Programming (select one option)

- P** - Programmed with HID Prox or Indala format
- N** - Unprogrammed HID Prox for iCLASS SE encoder (CP1000)

Front Packaging (select one option)

- G** - Plain White with Gloss Finish
- C** - Custom Artwork with Gloss Finish - Specify Custom Artwork Number³

Back Packaging (select one option)

- G** - Plain White with Gloss Finish²
- 1** - Plain White with Gloss Finish with Magnetic Stripe²
- C** - Custom Artwork with Gloss Finish - Specify Custom Artwork Number^{2,3}
- 3** - Custom Artwork with Gloss Finish with Magnetic Stripe - Specify Custom Artwork Number^{2,3}

13.56 MHz DESFire Card Numbering⁴ (select one option)

- N** - No Printed Card Numbering
- A** - Sequential Matching Encoded/Printed (Laser Engraved)
- B** - Sequential Encoded/Sequential Non-Matching Printed (Laser Engraved)
- C** - Random Encoded/Non-Matching Sequential Printed (Laser Engraved)

Slot Punch

N - No Slot Punch.

IMPORTANT: 811 credentials do not allow a slot punch due to antenna design. Use a badge holder to attach this card to a lanyard or badge clip.

125 kHz Card Numbering⁴

- N** - No Printed Card Numbering
- A** - Sequential Matching Encoded/Printed (Laser Engraved)
- B** - Sequential Encoded/Sequential Non-Matching Printed (Laser Engraved)
- C** - Random Encoded/Non-Matching Sequential Printed (Laser Engraved)

Option - Custom Artwork³

_____ (Specify Artwork Number - Refer to the Custom Artwork Forms for new Artwork)

Enter your final card options from check boxes above. Example: 811FPPGGANA

Final Part Number	811	F						N		-	(Options #)
-------------------	-----	---	--	--	--	--	--	---	--	---	-------------

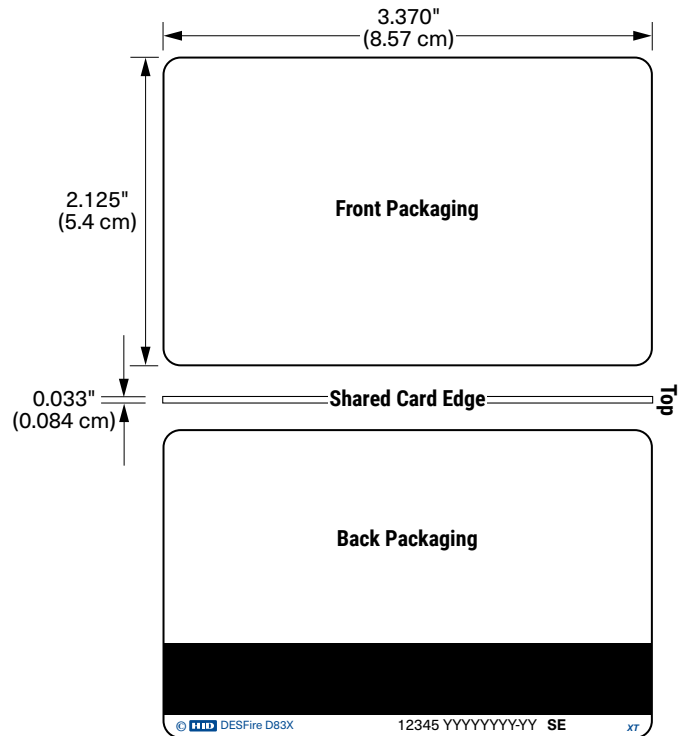

12345 = Card ID Number
YYYYYYY-YY = Sales Order Number



DESFire EV3 Card Programming Information

Format Number	Field Name(s) e.g. Facility Code	Value	QTY	Encoded Start Number	Encoded Stop Number
HID Elite ICE				Printed Start Number	Printed Stop Number

125 kHz Card Programming Information

Format Number	Field Name(s) e.g. Facility Code	Value	QTY	Encoded Start Number	Encoded Stop Number
				Printed Start Number	Printed Stop Number

¹ Card allows free create/delete of third party applications.

² Cards ordered with plain white front and back packaging, with no HID artwork or with custom artwork, will still have a small "HID logo"  and reference number printed in the lower left-hand corner on the back of the card. A custom part number is required to omit all marking.

³ For new artwork files, contact Customer Service for custom artwork number, lead-times, and cost.

⁴ The Printed card number is placed in the bottom right-hand corner on the back of the card.

MIFARE DESFire EV3 + Prox: Custom Profile - 810

Migration solution from Proximity to either fully customized bespoke DESFire specifications, or unprogrammed for full in-field personalization with EV1, EV2 or EV3 compliant solutions.

Compatibility: Supported by custom profile HID Signo, iCLASS SE and multiCLASS SE readers.

Ensure each required option has been checked with the appropriate choice to fulfill a completed order form.

Base Model **810 Composite (40% Polyester/PVC)**

MIFARE DESFire EV3 Memory Size

F - 8K Bytes DESFire EV3 DESFire Programming (select one option)

DESFire Programming (select one option)

- N** - Unprogrammed for use with iCLASS SE Encoder (EV1 custom encoding only) or third-party EV1, EV2 or EV3 applications.
- S** - Custom EV1, EV2 or EV3 programming (custom part number required)¹

Prox Programming (select one option)

- P** - Programmed with HID Prox or Indala format
- N** - Unprogrammed HID Prox for iCLASS SE encoder (CP1000)

Front Packaging (select one option)

- G** - Plain White with Gloss Finish
- C** - Custom Artwork with Gloss Finish - Specify Custom Artwork Number³

Back Packaging (select one option)

- G** - Plain White with Gloss Finish²
- 1** - Plain White with Gloss Finish with Magnetic Stripe²
- C** - Custom Artwork with Gloss Finish - Specify Custom Artwork Number^{2,3}
- 3** - Custom Artwork with Gloss Finish with Magnetic Stripe - Specify Custom Artwork Number^{2,3}

13.56 MHz DESFire Card Numbering⁴ (select one option)

- N** - No Printed Card Numbering
- A** - Sequential Matching Encoded/Printed (Laser Engraved)⁴
- B** - Sequential Encoded/Sequential Non-Matching Printed (Laser Engraved)
- C** - Random Encoded/Non-Matching Sequential Printed (Laser Engraved)

Slot Punch

N - No Slot Punch.

IMPORTANT: 810 credentials do not allow a slot punch due to antenna design. Use a badge holder to attach this card to a lanyard or badge clip.

125 kHz Card Numbering⁴

- N** - No Printed Card Numbering
- A** - Sequential Matching Encoded/Printed (Laser Engraved)
- B** - Sequential Encoded/Sequential Non-Matching Printed (Laser Engraved)
- C** - Random Encoded/Non-Matching Sequential Printed (Laser Engraved)

Option - Custom Artwork³

_____ (Specify Artwork Number - Refer to the Custom Artwork Forms for new Artwork)

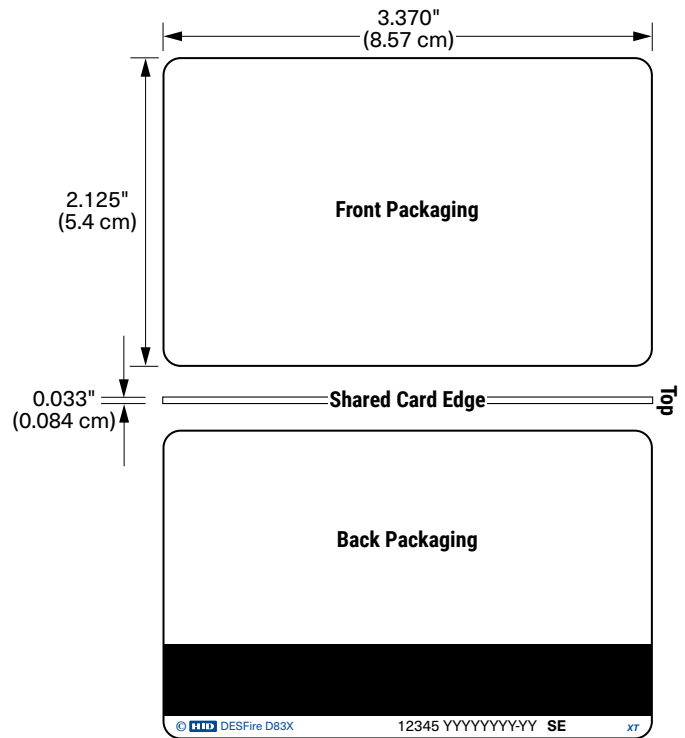

12345 = Card ID Number
YYYYYYY-YY = Sales Order Number



Enter your final card options from check boxes above. Example: 810FNPPGNNNA

Final Part Number	810	F						N		-	(Options #)
-------------------	-----	---	--	--	--	--	--	---	--	---	-------------

DESFire EV3 Card Programming Information

Format Number	Field Name(s) e.g. Facility Code	Value	QTY	Encoded Start Number	Encoded Stop Number
HID Elite ICE				Printed Start Number	Printed Stop Number

125 kHz Card Programming Information

Format Number	Field Name(s) e.g. Facility Code	Value	QTY	Encoded Start Number	Encoded Stop Number
				Printed Start Number	Printed Stop Number

¹ Contact your local sales or pre-sales representative, HID requires a full written specification, additional lead time applies for setup, test, and evaluation of custom profiles.

² Cards ordered with plain white front and back packaging, with no HID artwork or with custom artwork, will still have a small "HID logo"  and reference number printed in the lower left-hand corner on the back of the card. A custom part number is required to omit all marking.

³ For new artwork files, contact Customer Service for custom artwork number, lead-times, and cost.

⁴ The Printed card number is placed in the bottom right-hand corner on the back of the card. The permanent unique MIFARE DESFire 56 Bit serial # cannot be printed on cards.

MIFARE DESFire EV3 + iCLASS 32k Technology Card: High Security Profile - 822

Enhanced security and privacy on EV3, programmed with an enhanced application that leverages the new features of EV3 plus a Secure Identity Object (SIO). Offers iCLASS technology to simplify card issuance for diverse systems or migration projects.

DESFire EV3 Compatibility: Supported by HID Signo readers with firmware 10.0.2.4 or higher.

Ensure each required option has been checked with the appropriate choice to fulfill a completed order form.

Base Model **822 Composite (40% Polyester/PVC)**

MIFARE DESFire EV3 Memory Size

F - 8K Bytes

iCLASS 32K Memory Configuration

- 3** - 32k bit (4K bytes) application areas 16k/2+16k/1
- 4** - 32k bits (4K bytes) application areas 16k/16+16k/1

DESFire Secure Identity Object Programming¹

- P** - Programmed with enhanced EV3 application with Secure Identity Object (SIO)
Based on random UID for improved ISO14443A privacy of user data.
Compatible with Signo Reader firmware 10.0.2.4 or higher.
This profile is not compatible with iCLASS/MultiCLASS rev E.

iCLASS Programming (select one option)

- P** - Programmed with Secure Identity Object (SIO)
- S** - Programmed with Secure Identity Object (SIO) and standard iCLASS access control application
- H** - Programmed with standard iCLASS access control application
- V** - Unprogrammed for use with iCLASS SE Encoder (SIO programming only)
- C** - Unprogrammed for use with iCLASS SE Encoder (standard iCLASS application programming only)

Front Packaging (select one option)

- G** - Plain White with Gloss Finish
- C** - Custom Artwork with Gloss Finish – Specify Custom Artwork Number³

Back Packaging (select one option)

- G** - Plain White with Gloss Finish²
- 1** - Plain White with Gloss Finish with Magnetic Stripe²
- C** - Custom Artwork with Gloss Finish – Specify Custom Artwork Number^{2,3}
- 3** - Custom Artwork with Gloss Finish with Magnetic Stripe – Specify Custom Artwork Number^{2,3}

DESFire Card Numbering⁴ (select one option)

- N** - No Printed Card Numbering, sales number marking only
- A** - Sequential Matching Encoded/Printed (Laser Engraved)
- B** - Sequential Encoded/Sequential Non-Matching Printed (Laser Engraved)
- C** - Random Encoded/Non-Matching Sequential Printed (Laser Engraved)

Slot Punch

N - No Slot Punch.

IMPORTANT – 822 credentials do not allow a slot punch due to antenna design. Use a badge holder to attach this card to a lanyard or badge clip.

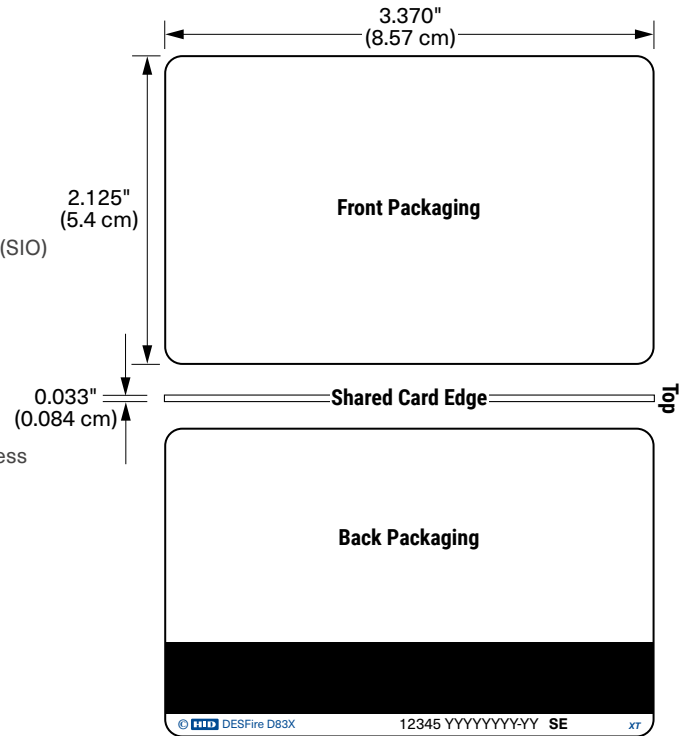

12345 = Card ID Number
YYYYYYYYYY = Sales Order Number



iCLASS Card Numbering⁴ (select one option)

- N** - No Printed Card Numbering, sales number marking only
- A** - Sequential Matching Encoded/Printed (Laser Engraved)
- B** - Sequential Encoded/Sequential Non-Matching Printed (Laser Engraved)
- C** - Random Encoded/Non-Matching Sequential Printed (Laser Engraved)

Option - Custom Artwork³

_____ (Specify Artwork Number - Refer to the Custom Artwork Forms for new Artwork)

Enter your final card options from check boxes above. Example: 822F4PPGGANA

Final Part Number	822	F		P					N		-	(Options #)
-------------------	-----	---	--	---	--	--	--	--	---	--	---	-------------

DESFire EV3 Card Programming Information

Format Number	Field Name(s) e.g. Facility Code	Value	QTY	Encoded Start Number	Encoded Stop Number
HID Elite ICE/MOB #				Printed Start Number	Printed Stop Number

iCLASS Card Programming Information

Format Number	Field Name(s) e.g. Facility Code	Value	QTY	Encoded Start Number	Encoded Stop Number
HID Elite ICE				Printed Start Number	Printed Stop Number

¹ Third party applications are required to support random UID, if in doubt, consult with the application vendor. Card allows free create/delete of third-party applications.

² Cards ordered with plain white front and back packaging, or with custom artwork, will still have the HID logo and reference artwork "**HID**" printed in the lower left-hand corner. A custom part number is required to omit the HID logo and reference artwork.

³ For new artwork files, contact Customer Service for custom artwork number, lead-times, and cost.

⁴ The printed card number, sales order reference and additional programming designators are placed in the bottom right-hand corner on the back of the card. A custom part number is required to omit this marking from the card.

MIFARE DESFire EV3 + iCLASS Card: Compatibility Profile - 821

Offers the flexibility of DESFire EV3 backwards compatibility with iCLASS SE readers and third-party applications that rely on static UID. Programmed additionally with the enhanced application that leverages the new features of EV3 plus a Secure Identity Object (SIO) that is supported by HID Signo readers with firmware 10.0.2.4 or greater. Offers iCLASS technology to simplify card issuance for diverse systems or migration projects.

DESFire EV3 Compatibility: Supported by HID Signo reader, iCLASS SE and multiCLASS SE.

Ensure each required option has been checked with the appropriate choice to fulfill a completed order form.

Base Model **821 Composite (40% Polyester/PVC)**

MIFARE DESFire EV3 Memory Size

F - 8K Bytes

iCLASS 32K Memory Configuration

- 3** - 32k bit (4K bytes) application areas 16k/2+16k/1
- 4** - 32k bits (4K bytes) application areas 16k/16+16k/1

DESFire Secure Identity Object Programming¹

- P** - Programmed with enhanced EV3 application with Secure Identity Object (SIO) plus an additional backwards compatible EV1 application with SIO.
- V** - Unprogrammed for use with iCLASS SE Encoder (EV1 compatible SIO application programming only)

iCLASS Programming (select one option)

- P** - Programmed with Secure Identity Object (SIO)
- S** - Programmed with Secure Identity Object (SIO) and standard iCLASS access control application
- H** - Programmed with standard iCLASS access control application
- V** - Unprogrammed for use with iCLASS SE Encoder (SIO programming only)
- C** - Unprogrammed for use with iCLASS SE Encoder (standard iCLASS application programming only)

Front Packaging (select one option)

- G** - Plain White with Gloss Finish
- C** - Custom Artwork with Gloss Finish – Specify Custom Artwork Number¹

Back Packaging (select one option)

- G** - Plain White with Gloss Finish²
- 1** - Plain White with Gloss Finish with Magnetic Stripe²
- C** - Custom Artwork with Gloss Finish – Specify Custom Artwork Number^{2,3}
- 3** - Custom Artwork with Gloss Finish with Magnetic Stripe – Specify Custom Artwork Number^{2,3}

DESFire Card Numbering⁴ (select one option)

- N** - No Printed Card Numbering, sales number marking only
- A** - Sequential Matching Encoded/Printed (Laser Engraved)
- B** - Sequential Encoded/Sequential Non-Matching Printed (Laser Engraved)
- C** - Random Encoded/Non-Matching Sequential Printed (Laser Engraved)

Slot Punch

N - No Slot Punch.

IMPORTANT – 822 credentials do not allow a slot punch due to antenna design. Use a badge holder to attach this card to a lanyard or badge clip.

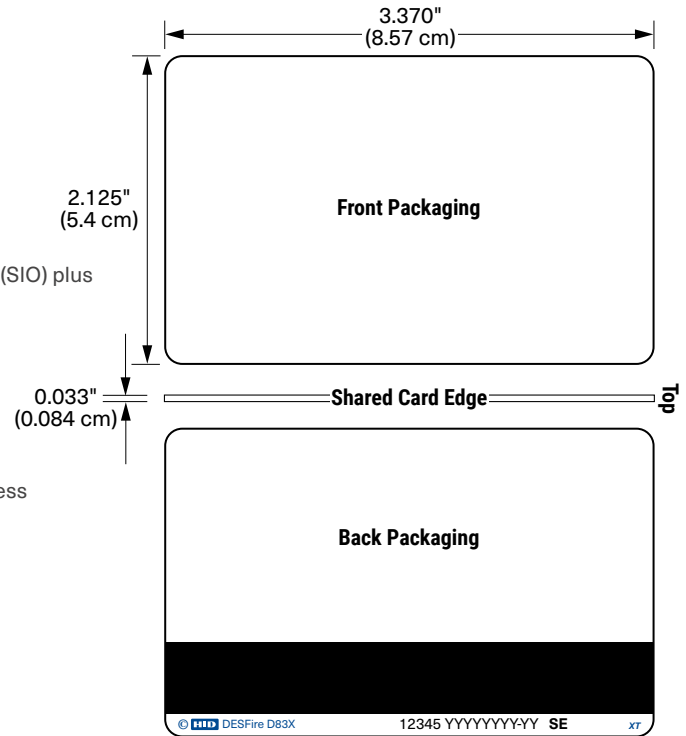

12345 = Card ID Number
YYYYYYY-YY = Sales Order Number



iCLASS Card Numbering⁴ (select one option)

- N** - No Printed Card Numbering, sales number marking only
- A** - Sequential Matching Encoded/Printed (Laser Engraved)
- B** - Sequential Encoded/Sequential Non-Matching Printed (Laser Engraved)
- C** - Random Encoded/Non-Matching Sequential Printed (Laser Engraved)

Option - Custom Artwork³

_____ (Specify Artwork Number - Refer to the Custom Artwork Forms for new Artwork)

Enter your final card options from check boxes above. Example: 821F4PPGGANA

Final Part Number	821	F							N		-	(Options #)
-------------------	-----	---	--	--	--	--	--	--	---	--	---	-------------

DESFire EV3 Card Programming Information

Format Number	Field Name(s) e.g. Facility Code	Value	QTY	Encoded Start Number	Encoded Stop Number
HID Elite ICE				Printed Start Number	Printed Stop Number

iCLASS Card Programming Information

Format Number	Field Name(s) e.g. Facility Code	Value	QTY	Encoded Start Number	Encoded Stop Number
HID Elite ICE				Printed Start Number	Printed Stop Number

¹ Card allows free create/delete of third-party applications.

² Cards ordered with plain white front and back packaging, or with custom artwork, will still have the HID logo and reference artwork "**HID**" printed in the lower left-hand corner. A custom part number is required to omit the HID logo and reference artwork.

³ For new artwork files, contact Customer Service for custom artwork number, lead-times, and cost.

⁴ The printed card number, sales order reference and additional programming designators are placed in the bottom right-hand corner on the back of the card. A custom part number is required to omit this marking from the card.

MIFARE DESFire EV3 + iCLASS 32K Card: Custom Profile - 820

Available customized to bespoke specifications, or unprogrammed for full in-field personalization compatible with EV1, EV2, or EV3 compliant solutions. Offers iCLASS technology to simplify card issuance for diverse systems or migration projects.

Compatibility: Supported by custom profile HID Signo, iCLASS SE and multiCLASS SE readers.

Ensure each required option has been checked with the appropriate choice to fulfill a completed order form.

Card **without** SIO encoding

Base Model **820 Composite (40% Polyester/PVC)**

MIFARE DESFire EV3 Memory Size

F - 8K Bytes

iCLASS 32K Memory Configuration

- 3** - 32k bit (4K bytes) application areas 16k/2+16k/1
- 4** - 32k bits (4K bytes) application areas 16k/16+16k/1

DESFire Programming¹ (select one option)

- N** - Unprogrammed DESFire EV3 for use with iCLASS SE Encoder (EV1 custom encoding only) or third-party EV1, EV2, or EV3 applications.
- S** - Custom MIFARE DESFire EV1, EV2, or EV3 programming, requires custom part number.

iCLASS Programming (select one option)

- P** - Programmed with Secure Identity Object (SIO)
- S** - Programmed with Secure Identity Object (SIO) and standard iCLASS access control application
- H** - Programmed with standard iCLASS access control application
- V** - Unprogrammed for use with iCLASS SE Encoder (SIO programming only)
- C** - Unprogrammed for use with iCLASS SE Encoder (standard iCLASS application programming only)

Front Packaging (select one option)

- G** - Plain White with Gloss Finish
- C** - Custom Artwork with Gloss Finish – Specify Custom Artwork Number³

Back Packaging (select one option)

- G** - Plain White with Gloss Finish²
- 1** - Plain White with Gloss Finish with Magnetic Stripe²
- C** - Custom Artwork with Gloss Finish – Specify Custom Artwork Number^{2,3}
- 3** - Custom Artwork with Gloss Finish with Magnetic Stripe – Specify Custom Artwork Number^{2,3}

DESFire Card Numbering⁴ (select one option)

- N** - No Printed Card Numbering, sales number marking only
- A** - Sequential Matching Encoded/Printed (Laser Engraved)
- B** - Sequential Encoded/Sequential Non-Matching Printed (Laser Engraved)
- C** - Random Encoded/Non-Matching Sequential Printed (Laser Engraved)
- Z** - Reversed UID (CSN) decimal card numbering only (Laser Engraved)⁵

Slot Punch

N - No Slot Punch.

IMPORTANT – 820 credentials do not allow a slot punch due to antenna design. Use a badge holder to attach this card to a lanyard or badge clip.

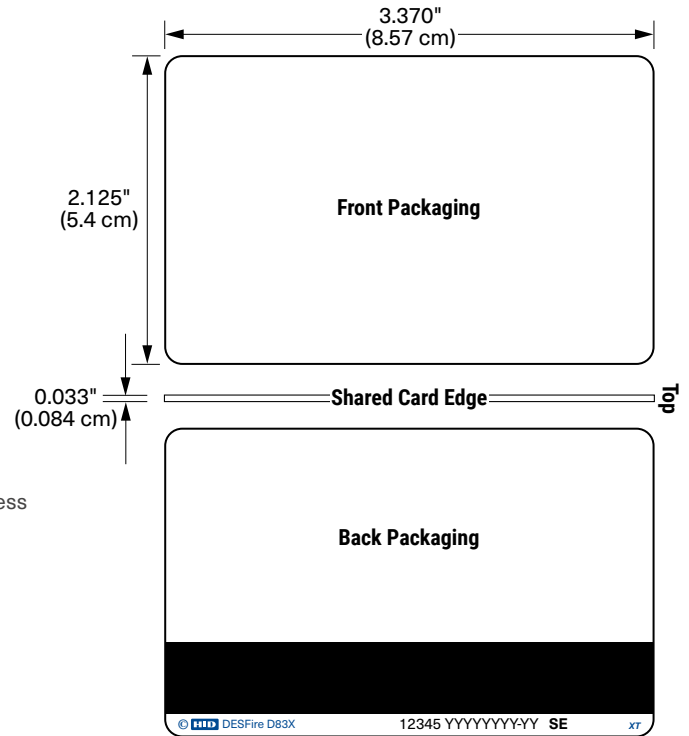

12345 = Card ID Number
YYYYYYY-YY = Sales Order Number



iCLASS Card Numbering⁴ (select one option)

- N** - No Printed Card Numbering, sales number marking only
- A** - Sequential Matching Encoded/Printed (Laser Engraved)
- B** - Sequential Encoded/Sequential Non-Matching Printed (Laser Engraved)

Option - Custom Artwork¹

_____ (Specify Artwork Number - Refer to the Custom Artwork Forms for new Artwork)

Enter your final card options from check boxes above. Example: 820F4NPPGNNA

Final Part Number	820	F							N		-	(Options #)
-------------------	-----	---	--	--	--	--	--	--	---	--	---	-------------

DESFire EV3 Card Programming Information

Format Number	Field Name(s) e.g. Facility Code	Value	QTY	Encoded Start Number	Encoded Stop Number
				Printed Start Number	Printed Stop Number

iCLASS Card Programming Information

Format Number	Field Name(s) e.g. Facility Code	Value	QTY	Encoded Start Number	Encoded Stop Number
HID Elite ICE					
				Printed Start Number	Printed Stop Number

¹ For custom programming options please contact your local sales or pre-sales representative.

² Cards ordered with plain white front and back packaging, or with custom artwork, will still have the HID logo and reference artwork "HID" printed in the lower left-hand corner. A custom part number is required to omit the HID logo and reference artwork.

³ For new artwork files, contact Customer Service for custom artwork number, lead-times, and cost.

⁴ The printed card number, sales order reference and additional programming designators are placed in the bottom right-hand corner on the back of the card. A custom part number is required to omit this marking from the card.

⁵ If selecting DESFire marking option "Z" there will not be room to mark any other technologies.

MIFARE DESFire EV3 + iCLASS 32K + Prox Card: High Security Profile - 832

Enhanced security and privacy on EV3, programmed with an enhanced application that leverages the new features of EV3 plus a Secure Identity Object (SIO). Offers iCLASS and 125kHz technology to simplify card issuance for diverse systems or migration projects.

DESFire EV3 Compatibility: Supported by HID Signo readers with firmware 10.0.2.4 or higher.

Ensure each required option has been checked with the appropriate choice to fulfill a completed order form.

Base Model **832 Composite (40% Polyester/PVC)**

MIFARE DESFire EV3 Memory Size

F - 8K Bytes

iCLASS 32K Memory Configuration

- 3** - 32k bit (4K bytes) application areas 16k/2+16k/1
- 4** - 32k bits (4K bytes) application areas 16k/16+16k/1

DESFire Secure Identity Object Programming¹

- P** - Programmed with enhanced EV3 application with Secure Identity Object (SIO)
Based on random UID for improved privacy of user data.
Compatible with Signo Reader firmware 10.0.2.4 or higher.
This profile is not compatible with iCLASS/MultiCLASS rev E.

iCLASS Programming (select one option)

- P** - Programmed with Secure Identity Object (SIO)
- S** - Programmed with Secure Identity Object (SIO) and standard iCLASS access control application
- H** - Programmed with standard iCLASS access control application
- V** - Unprogrammed for use with iCLASS SE Encoder (SIO programming only)
- C** - Unprogrammed for use with iCLASS SE Encoder (standard iCLASS application programming only)

125kHz Programming (select one option)

- P** - Programmed with HID Prox or Indala format.
- N** - Unprogrammed HID Prox for iCLASS SE encoder (CP1000)

Front Packaging (select one option)

- G** - Plain White with Gloss Finish
- C** - Custom Artwork with Gloss Finish – Specify Custom Artwork Number²

Back Packaging (select one option)

- G** - Plain White with Gloss Finish²
- 1** - Plain White with Gloss Finish with Magnetic Stripe²
- C** - Custom Artwork with Gloss Finish – Specify Custom Artwork Number^{2,3}
- 3** - Custom Artwork with Gloss Finish with Magnetic Stripe – Specify Custom Artwork Number^{2,3}

DESFire Card Numbering⁴ (select one option)

- N** - No Printed Card Numbering
- A** - Sequential Matching Encoded/Printed (Laser Engraved)
- B** - Sequential Encoded/Sequential Non-Matching Printed (Laser Engraved)
- C** - Random Encoded/Non-Matching Sequential Printed (Laser Engraved)

Slot Punch

N - No Slot Punch.

IMPORTANT – 832 credentials do not allow a slot punch due to antenna design. Use a badge holder to attach this card to a lanyard or badge clip.

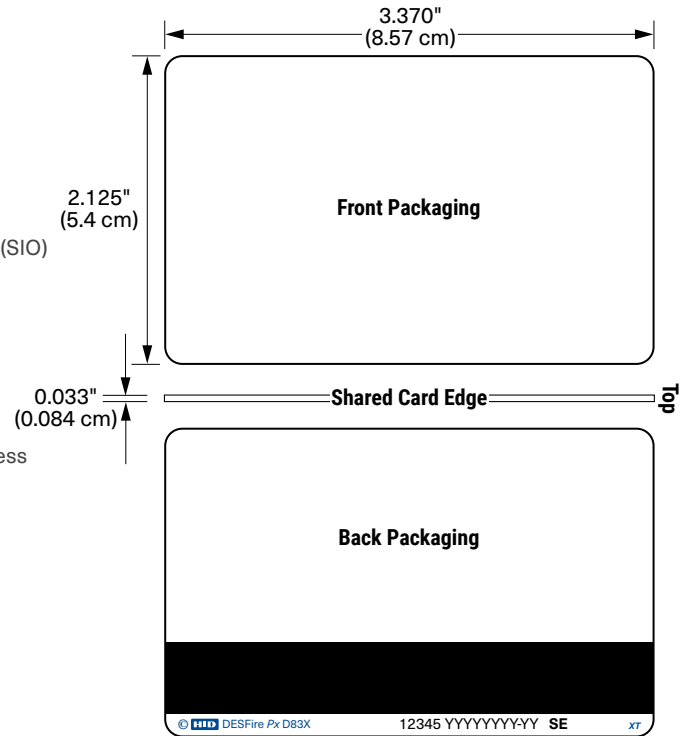

12345 = Card ID Number
YYYYYYY-YY = Sales Order Number



iCLASS Card Numbering⁴ (select one option)

- N** - No Printed Card Numbering
- A** - Sequential Matching Encoded/Printed (Laser Engraved)
- B** - Sequential Encoded/Sequential Non-Matching Printed (Laser Engraved)
- C** - Random Encoded/Non-Matching Sequential Printed (Laser Engraved)

125 kHz Card Numbering⁴

- N** - No Printed Card Numbering
- A** - Sequential Matching Encoded/Printed (Laser Engraved)
- B** - Sequential Encoded/Sequential Non-Matching Printed (Laser Engraved)
- C** - Random Encoded/Non-Matching Sequential Printed (Laser Engraved)

Option - Custom Artwork¹

_____ (Specify Artwork Number - Refer to the Custom Artwork Forms for new Artwork)

Enter your final card options from check boxes above. Example: 832F4PPPGANAA

Final Part Number	832	F		P						N			-	(Options #)
-------------------	-----	---	--	---	--	--	--	--	--	---	--	--	---	-------------

DESFire EV3 Card Programming Information

Format Number	Field Name(s) e.g. Facility Code	Value	QTY	Encoded Start Number	Encoded Stop Number
HID Elite ICE				Printed Start Number	Printed Stop Number

iCLASS Card Programming Information

Format Number	Field Name(s) e.g. Facility Code	Value	QTY	Encoded Start Number	Encoded Stop Number
HID Elite ICE				Printed Start Number	Printed Stop Number

125kHz Card Programming Information

Format Number	Field Name(s) e.g. Facility Code	Value	QTY	Encoded Start Number	Encoded Stop Number
				Printed Start Number	Printed Stop Number

¹ Third party applications are required to support random UID, if in doubt, consult with the application vendor. Card allows free create/delete of third-party applications.

² Cards ordered with plain white front and back packaging, or with custom artwork, will still have the HID logo and reference artwork "HID" printed in the lower left-hand corner. A custom part number is required to omit the HID logo and reference artwork.

³ For new artwork files, contact Customer Service for custom artwork number, lead-times, and cost.

⁴ The printed card number, sales order reference and additional programming designators are placed in the bottom right-hand corner on the back of the card. A custom part number is required to omit this marking from the card.

MIFARE DESFire EV3 + iCLASS + Prox Card: Compatibility Profile - 831

Offers the flexibility of DESFire EV3 backwards compatibility with iCLASS SE readers and third-party applications that rely on static UID. Programmed additionally with the enhanced application that leverages the new features of EV3 plus a Secure Identity Object (SIO) that is supported by HID Signo readers with firmware 10.0.2.4 or greater. Offers iCLASS and 125kHz technology to simplify card issuance for diverse systems or migration projects.

Compatibility: Supported by HID Signo reader, iCLASS SE and multiCLASS SE.

Ensure each required option has been checked with the appropriate choice to fulfill a completed order form.

Base Model **831 Composite (40% Polyester/PVC)**

MIFARE DESFire EV3 Memory Size

F - 8K Bytes

iCLASS 32K Memory Configuration

- 3** - 32k bit (4K bytes) application areas 16k/2+16k/1
- 4** - 32k bits (4K bytes) application areas 16k/16+16k/1

DESFire Secure Identity Object Programming¹

- P** - Programmed with enhanced EV3 application with Secure Identity Object (SIO) plus an additional backwards compatible EV1 application with SIO.
- V** - Unprogrammed for use with iCLASS SE Encoder (EV1 compatible SIO application programming only)

iCLASS Programming (select one option)

- P** - Programmed with Secure Identity Object (SIO)
- S** - Programmed with Secure Identity Object (SIO) and standard iCLASS access control application
- H** - Programmed with standard iCLASS access control application
- V** - Unprogrammed for use with iCLASS SE Encoder (SIO programming only)
- C** - Unprogrammed for use with iCLASS SE Encoder (standard iCLASS application programming only)

Prox Programming (select one option)

- P** - Programmed with HID Prox or Indala format.
- N** - Unprogrammed HID Prox for iCLASS SE encoder (CP1000)

Front Packaging (select one option)

- G** - Plain White with Gloss Finish
- C** - Custom Artwork with Gloss Finish – Specify Custom Artwork Number²

Back Packaging (select one option)

- G** - Plain White with Gloss Finish²
- 1** - Plain White with Gloss Finish with Magnetic Stripe²
- C** - Custom Artwork with Gloss Finish – Specify Custom Artwork Number^{2,3}
- 3** - Custom Artwork with Gloss Finish with Magnetic Stripe – Specify Custom Artwork Number^{2,3}

DESFire Card Numbering⁴ (select one option)

- N** - No Printed Card Numbering
- A** - Sequential Matching Encoded/Printed (Laser Engraved)
- B** - Sequential Encoded/Sequential Non-Matching Printed (Laser Engraved)
- C** - Random Encoded/Non-Matching Sequential Printed (Laser Engraved)

Slot Punch

N - No Slot Punch.

IMPORTANT – 831 credentials do not allow a slot punch due to antenna design. Use a badge holder to attach this card to a lanyard or badge clip.

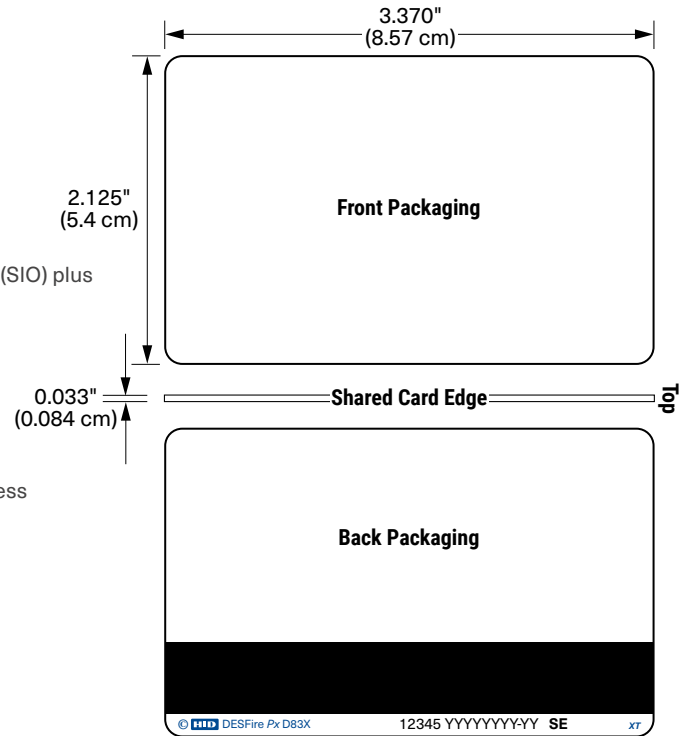

© HID DESFire Px D83X 12345 YYYYYYYY SE XT

12345 = Card ID Number
YYYYYYY-YY = Sales Order Number

iCLASS Card Numbering⁴ (select one option)

- N** - No Printed Card Numbering, sales number marking only
- A** - Sequential Matching Encoded/Printed (Laser Engraved)
- B** - Sequential Encoded/Sequential Non-Matching Printed (Laser Engraved)
- C** - Random Encoded/Non-Matching Sequential Printed (Laser Engraved)

125 kHz Card Numbering⁴

- N** - No Printed Card Numbering
- A** - Sequential Matching Encoded/Printed (Laser Engraved)
- B** - Sequential Encoded/Sequential Non-Matching Printed (Laser Engraved)
- C** - Random Encoded/Non-Matching Sequential Printed (Laser Engraved)

Option - Custom Artwork¹

_____ (Specify Artwork Number - Refer to the Custom Artwork Forms for new Artwork)

Enter your final card options from check boxes above. Example: 831F4PPPGGANAA

Final Part Number	831	F								N			-	(Options #)
-------------------	-----	---	--	--	--	--	--	--	--	---	--	--	---	-------------

DESFire EV3 Card Programming Information

Format Number	Field Name(s) e.g. Facility Code	Value	QTY	Encoded Start Number	Encoded Stop Number
HID Elite ICE				Printed Start Number	Printed Stop Number

iCLASS Card Programming Information

Format Number	Field Name(s) e.g. Facility Code	Value	QTY	Encoded Start Number	Encoded Stop Number
HID Elite ICE				Printed Start Number	Printed Stop Number

125kHz Card Programming Information

Format Number	Field Name(s) e.g. Facility Code	Value	QTY	Encoded Start Number	Encoded Stop Number
				Printed Start Number	Printed Stop Number

¹ Card allows free create/delete of third-party applications.

² Cards ordered with plain white front and back packaging, or with custom artwork, will still have the HID logo and reference artwork "HID" printed in the lower left-hand corner. A custom part number is required to omit the HID logo and reference artwork.

³ For new artwork files, contact Customer Service for custom artwork number, lead-times, and cost.

⁴ The printed card number, sales order reference and additional programming designators are placed in the bottom right-hand corner on the back of the card. A custom part number is required to omit this marking from the card.

MIFARE DESFire EV3 + iCLASS 32k + Prox Card: Custom Profile - 830

Migration solution from Proximity to fully customized bespoke DESFire specifications, or unprogrammed for full in-field personalization with EV1, EV2, or EV3 compliant solutions. Offers iCLASS and 125kHz technology to simplify card issuance for diverse systems or migration projects.

Compatibility: Supported by custom profile HID Signo, iCLASS SE and multiCLASS SE readers.

Ensure each required option has been checked with the appropriate choice to fulfill a completed order form.

Card without SIO encoding + Prox
Base Model **830 Composite (40% Polyester/PVC)**

MIFARE DESFire EV3 Memory Size

F - 8K Bytes DESFire EV3

iCLASS 32K Memory Configuration

- 3** - 32k bit (4K bytes) application areas 16k/2+16k/1
- 4** - 32k bits (4K bytes) application areas 16k/16+16k/1

DESFire Programming¹ (select one option)

- N** - Unprogrammed for use with iCLASS SE Encoder (EV1 custom encoding only) or third-party EV1, EV2, or EV3 applications.
- S** - Custom EV1, EV2, or EV3 programming (custom part number required).

iCLASS Programming (select one option)

- P** - Programmed with Secure Identity Object (SIO)
- S** - Programmed with Secure Identity Object (SIO) and standard iCLASS access control application
- H** - Programmed with standard iCLASS access control application
- V** - Unprogrammed for use with iCLASS SE Encoder (SIO programming only)
- C** - Unprogrammed for use with iCLASS SE Encoder (standard iCLASS application programming only)

Prox Programming (select one option)

- P** - Programmed with HID Prox or Indala format.
- N** - Unprogrammed HID Prox for iCLASS SE encoder (CP1000)

Front Packaging (select one option)

- G** - Plain White with Gloss Finish
- C** - Custom Artwork with Gloss Finish – Specify Custom Artwork Number³

Back Packaging (select one option)

- G** - Plain White with Gloss Finish²
- 1** - Plain White with Gloss Finish with Magnetic Stripe²
- C** - Custom Artwork with Gloss Finish – Specify Custom Artwork Number^{2,3}
- 3** - Custom Artwork with Gloss Finish with Magnetic Stripe – Specify Custom Artwork Number^{2,3}

13.56 MHz DESFire Card Numbering³ (select one option)

- N** - No Printed Card Numbering
- A** - Sequential Matching Encoded/Printed (Laser Engraved)⁴
- B** - Sequential Encoded/Sequential Non-Matching Printed (Laser Engraved)
- C** - Random Encoded/Non-Matching Sequential Printed (Laser Engraved)
- Z** - Reversed UID (CSN) Decimal card numbering only (Laser Engraved)⁵

Slot Punch

N - No Slot Punch.

IMPORTANT – 830 credentials do not allow a slot punch due to antenna design. Use a badge holder to attach this card to a lanyard or badge clip.

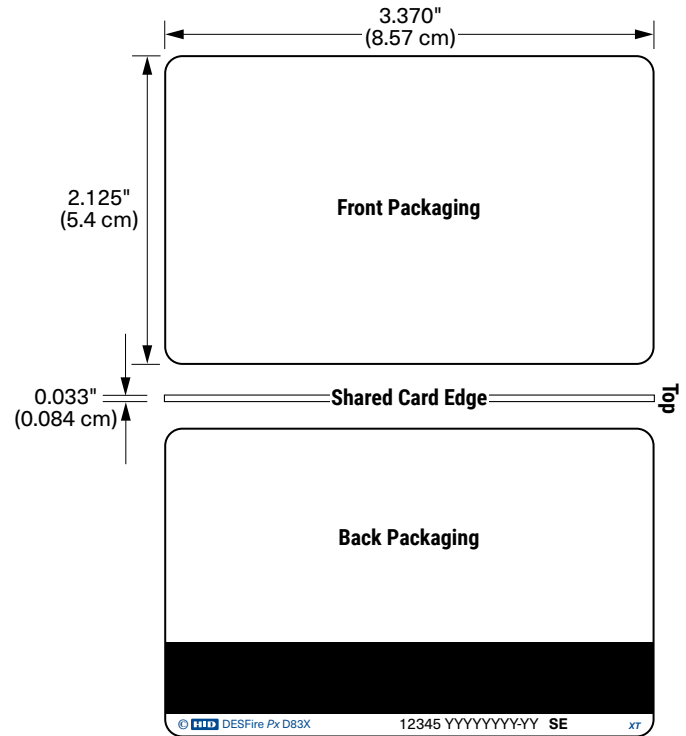

12345 = Card ID Number
YYYYYYY-YY = Sales Order Number



iCLASS Card Numbering⁴ (select one option)

- N** - No Printed Card Numbering, sales number marking only
- A** - Sequential Matching Encoded/Printed (Laser Engraved)
- B** - Sequential Encoded/Sequential Non-Matching Printed (Laser Engraved)

125 kHz Card Numbering³

- N** - No Printed Card Numbering
- A** - Sequential Matching Encoded/Printed (Laser Engraved)
- B** - Sequential Encoded/Sequential Non-Matching Printed (Laser Engraved)
- C** - Random Encoded/Non-Matching Sequential Printed (Laser Engraved)

Option - Custom Artwork³

_____ (Specify Artwork Number - Refer to the Custom Artwork Forms for new Artwork)

Enter your final card options from check boxes above. Example: 830F4NPPGGNNA

Final Part Number	830	F								N			-	(Options #)
-------------------	-----	---	--	--	--	--	--	--	--	---	--	--	---	-------------

DESFire EV3 Card Programming Information

Format Number	Field Name(s) e.g. Facility Code	Value	QTY	Encoded Start Number	Encoded Stop Number
				Printed Start Number	Printed Stop Number

iCLASS Card Programming Information

Format Number	Field Name(s) e.g. Facility Code	Value	QTY	Encoded Start Number	Encoded Stop Number
HID Elite ICE/MOB #				Printed Start Number	Printed Stop Number

125kHz Card Programming Information

Format Number	Field Name(s) e.g. Facility Code	Value	QTY	Encoded Start Number	Encoded Stop Number
				Printed Start Number	Printed Stop Number

¹ For custom programming options please contact your local sales or pre-sales representative.

² Cards ordered with plain white front and back packaging, with no HID artwork or with custom artwork, will still have a small "HID logo" and reference number printed in the lower left-hand corner and a slot punch target printed on the back of the card. A custom part number is required to omit all marking.

³ For new artwork files, contact Customer Service for custom artwork number, lead-times, and cost.

⁴ The printed card number, sales order reference and additional programming designators are placed in the bottom right-hand corner on the back of the card. A custom part number is required to omit this marking from the card.

⁵ If selecting DESFire marking option "Z" there will not be room to mark any other technologies.

MIFARE Credentials

MIFARE Classic Card - 340 / 345 / 1430 / 1440 / 1436 / 1446

Encompasses the industry's broadest range of open standard contactless smart card products. Provides the memory structure and capacity to store multiple applications on a single credential. All MIFARE Classic cards can be ordered with or without SIO encoding. Use of a 1430, 1440, 1436, or 1446 for SIO encoding using the CP1000 will consume a chargeable credit.

Ensure each required option has been checked with the appropriate choice to fulfill a completed order form.

MIFARE Classic cards with SIO encoding (Recommended)

- 3400 (1K) Standard PVC
- 3406 (4K) Standard PVC
- 3450 (1K) Composite 40% Polyester / PVC*
- 3456 (4K) Composite Polyester 40% / PVC*

Programming* (select one option)

- P** - Programmed with Security Identity Object (SIO) for MIFARE Classic
- V** - Unprogrammed Secure Identity object (SIO), for MIFARE Classic, for use with iCLASS SE Encoder.

OR

MIFARE Classic Cards without SIO encoding

- 1430 (1K) Standard PVC
- 1440 (4K) Standard PVC
- 1436 (1K) Composite 40% Polyester / PVC*
- 1446 (4K) Composite Polyester 40% / PVC*

Programming (select one option)

- M** - Programmed HID MIFARE6 access control application
- N** - Unprogrammed MIFARE Classic for use with iCLASS SE Encoder (custom or HID)
- S** - Custom programmed MIFARE Classic, requires custom part number

* A marker is placed in sector 6 and will not be available for other data

Front Packaging (select one option)

- G** - Plain White with Gloss Finish
- C** - Custom Artwork with Gloss Finish - Specify Custom Artwork Number¹

Back Packaging (select one option)

- G** - Plain White with Gloss Finish²
- 1** - Plain White with Gloss Finish with Magnetic Stripe²
- C** - Custom Artwork with Gloss Finish - Specify Custom Artwork Number^{1,2}
- 3** - Custom Artwork with Gloss Finish with Magnetic Stripe - Specify Custom Artwork Number^{1,2}

Card Numbering³ (select one option)

- M** - Sequential Matching Encoded/Printed (Inkjetted)⁷
- N** - No Printed Card Numbering
- U** - UID (CSN) HEX card numbering only (Inkjetted)^{4,7}
- V** - UID (CSN) Decimal card numbering only (Inkjetted)^{4,7}
- S** - Sequential Encoded/Sequential Non-Matching Printed (Inkjetted)⁷
- R** - Random Encoded/Non-Matching Sequential Printed (Inkjetted)⁷
- A** - Sequential Matching Encoded/Printed (Laser Engraved)
- B** - Sequential Encoded/Sequential Non-Matching Printed (Laser Engraved)
- C** - Random Encoded/Non-Matching Sequential Printed (Laser Engraved)
- Z** - Reversed UID (CSN) Decimal card numbering only (Laser Engraved)

Slot Punch⁵ (select one option)

- N** - No slot punch, Printed Vertical Slot Indicators
- V** - Vertical Slot Punch

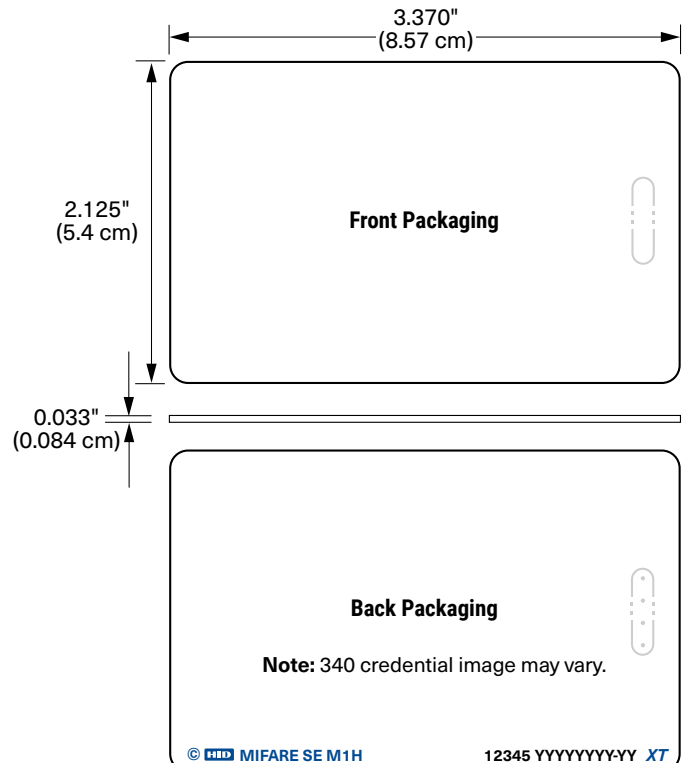

12345 = Card ID Number
YYYYYYYY-YY = Sales Order Number



Option - Custom Artwork¹

_____ (Specify Artwork Number - Refer to the Custom Artwork forms for new artwork)

Enter your final card options from check boxes above. Example: 3400PGGNN

Final Part Number								-		(Options #)
-------------------	--	--	--	--	--	--	--	---	--	-------------

13.56 MHz Card Programming Information

Format Number	Field Name(s) e.g. Facility Code	Value	QTY	Encoded Start Number	Encoded Stop Number
HID Elite ICE #				Printed Start Number	Printed Stop Number

* HID Elite key not applicable to base parts 1430, 1440, 1436, or 1446

¹ For new artwork files, contact Customer Service for custom artwork number, lead-times, and cost.

² Cards ordered with plain white front and back packaging, with no HID artwork or with custom artwork, will still have a small HID logo  and reference number printed in the lower left-hand corner and a slot punch target printed on the back of the card. Most part numbers are marked with the sales order number. A custom part number is required to omit all marking from the card. Contact your local support representative for details.

³ The Printed card number is placed in the bottom right-hand corner on the back of the card.

⁴ When printed, by default the number is encoded MSB (most significant byte) -> LSB (least significant byte).

⁵ Cards are provided with an optional slot punch at no additional charge. Some video imaging printers cannot accommodate pre-slot punched cards. Consult with the printer manufacturer prior to ordering.

⁶ Includes a permanent Unique MIFARE 32 Bit Serial number.

⁷ Please note that cards shipped within the Americas are always laser-engraved. Inkjetted option is not available for these cards.

* The composite construction is recommended for all cards with over-laminate applied.

MIFARE Classic + Prox Card - 350 / 355 / 1431 / 1441 / 1437 / 1447

Encompasses the industry's broadest range of open standard contactless smart card products. Provides the memory structure and capacity to store multiple applications on a single credential with the addition of Proximity technology for easier migration. All MIFARE Classic + Prox cards can be ordered with or without SIO encoding. Use of a 1431, 1441, 1437, or 1447 for SIO encoding using the CP1000 will consume a chargeable credit.

Ensure each required option has been checked with the appropriate choice to fulfill a completed order form.

MIFARE Classic + Prox Card with SIO encoding (Recommended)

- 3500 (1K) Standard PVC
- 3506 (4K) Standard PVC
- 3550 (1K) Composite 40% Polyester / PVC*
- 3556 (4K) Composite 40% Polyester / PVC*

Programming* (select one option)

- P** - Programmed 13.56 MHz with Security Identity Object (SIO) for MIFARE Classic, unprogrammed 125 kHz HID Prox for use with iCLASS SE Encoder
- R** - Programmed 13.56 MHz Security Identity Object (SIO) for MIFARE Classic, programmed 125 kHz with HID Prox or Indala format
- V** - Unprogrammed 13.56 MHz SIO for MIFARE (for use with iCLASS SE Encoder (SIO), unprogrammed 125 kHz HID Prox for use with iCLASS SE Encoder

* A marker is placed in sector 6 and will not be available for other data

OR MIFARE Classic + Prox Card without SIO encoding

- 1431 (1K) Standard PVC
- 1441 (4K) Standard PVC
- 1437 (1K) Composite 40% Polyester / PVC*
- 1447 (4K) Composite 40% Polyester / PVC*

Programming (select one option)

- L** - Programmed 125 kHz with HID Prox or Indala Format6, unprogrammed 13.56 MHz MIFARE Classic (for use with iCLASS SE Encoder custom or HID)
- M** - Programmed 13.56 MHz HID MIFARE⁶ access control application, unprogrammed 125 kHz HID Prox for use with iCLASS SE Encoder
- B** - Programmed 13.56 MHz with HID MIFARE⁶ access control application, programmed 125 kHz with HID Prox or Indala format
- N** - Unprogrammed 13.56 MHz MIFARE (for use with SE Encoder custom or HID), unprogrammed 125 kHz HID Prox for use with iCLASS SE Encoder
- S** - Custom Programmed 13.56 MHz MIFARE Classic, unprogrammed 125 kHz HID Prox for use with iCLASS SE Encoder, requires custom part number

Front Packaging (select one option)

- G** - Plain White with Gloss Finish
- C** - Custom Artwork with Gloss Finish - Specify Custom Artwork Number¹

Back Packaging (select one option)

- G** - Plain White with Gloss Finish²
- 1** - Plain White with Gloss Finish with Magnetic Stripe²
- C** - Custom Artwork with Gloss Finish - Specify Custom Artwork Number^{1,2}
- 3** - Custom Artwork with Gloss Finish with Magnetic Stripe - Specify Custom Artwork Number^{1,2}

13.56 MHz MIFARE Card Numbering³ (select one option)

- M** - Sequential Matching Encoded/Printed (Inkjetted)⁵
- N** - No Printed Card Numbering
- U** - UID (CSN) HEX card numbering only (Inkjetted)^{4,5}
- V** - UID (CSN) Decimal card numbering only (Inkjetted)^{4,5}
- S** - Sequential Encoded/Sequential Non-Matching Printed (Inkjetted)⁵
- R** - Random Encoded/Non-Matching Sequential Printed (Inkjetted)⁵
- A** - Sequential Matching Encoded/Printed (Laser Engraved)
- B** - Sequential Encoded/Sequential Non-Matching Printed (Laser Engraved)
- C** - Random Encoded/Non-Matching Sequential Printed (Laser Engraved)
- Z** - Reversed UID (CSN) Decimal card numbering only (Laser Engraved)

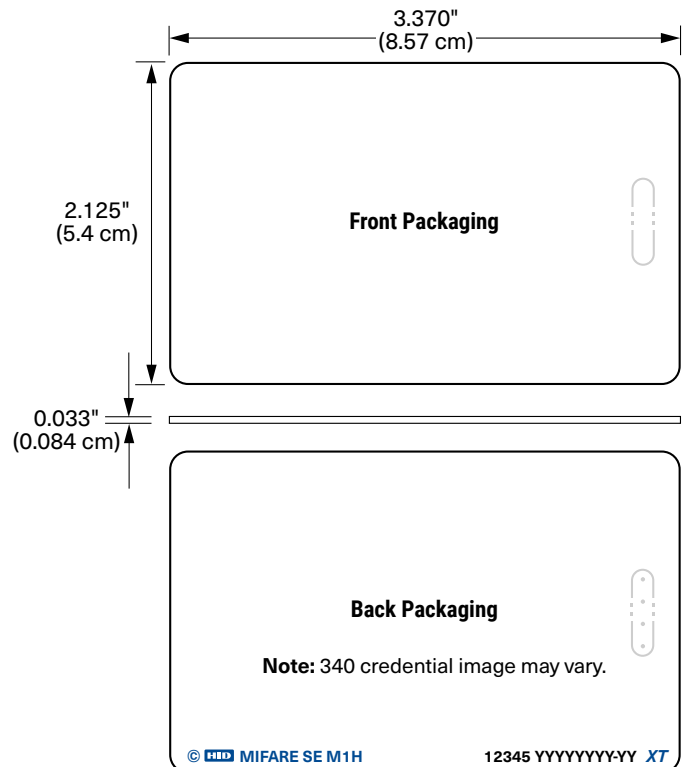



Slot Punch (select one option)

- N** - No slot punch. This card can be slotted vertically, Printed Vertical Slot Indicators
- V** - Vertical Slot Punch

125 kHz Proximity Card Numbering³ (select one option)

- M** - Sequential Matching Encoded/Printed (Inkjetted)
- N** - No Printed Card Numbering
- S** - Sequential Encoded/Sequential Non-Matching Printed (Inkjetted)
- R** - Random Encoded/Non-Matching Sequential Printed (Inkjetted)
- A** - Sequential Matching Encoded/Printed (Engraved)
- B** - Sequential Encoded/Sequential Non-Matching Printed (Engraved)
- C** - Random Encoded/Non-Matching Sequential Printed (Engraved)

Option - Custom Artwork¹

- (Specify Artwork Number - Refer to the Custom Artwork forms for new artwork)

Enter your final card options from check boxes above. Example: 3506PGGMNS

Final Part Number						N			-		(Options #)
-------------------	--	--	--	--	--	---	--	--	---	--	-------------

13.56 MHz Card Programming Information

Format Number	Field Name(s) e.g. Facility Code	Value	QTY	Encoded Start Number	Encoded Stop Number
HID Elite ICE #				Printed Start Number	Printed Stop Number

* HID Elite key not applicable to base parts 1431, 1441, 1437, or 1447

125 kHz Card Programming Information

Format Number	Field Name(s) e.g. Facility Code	Value	QTY	Encoded Start Number	Encoded Stop Number
				Printed Start Number	Printed Stop Number

¹ For new artwork files, contact Customer Service for custom artwork number, lead-times, and cost.

² Cards ordered with plain white front and back packaging, with no HID artwork or with custom artwork, will still have a small HID logo and reference number printed in the lower left-hand corner and a slot punch target printed on the back of the card. Most part numbers are marked with the sales order number. A custom part number is required to omit all marking from the card. Contact your local support representative for details.

³ The Printed card number is placed in the bottom right-hand corner on the back of the card.

⁴ When printed, by default the number is encoded MSB (most significant byte) -> LSB (least significant byte).

⁵ Please note that cards shipped within the Americas are always laser-engraved. Inkjetted option is not available for these cards.

⁶ Includes a permanent Unique MIFARE 32 Bit Serial number.

* The composite construction is recommended for all cards with over-laminate applied.

MIFARE Classic Keyfob - 1434 / 1444

Ensure each required option has been checked with the appropriate choice to fulfill a completed order form.

Base Model **1434 (1K)** **1444 (4K)**

Programming (select one option)

- M** - Programmed with HID MIFARE³ access control application
- N** - Unprogrammed MIFARE Classic
- S** - Custom Programmed MIFARE Classic, requires custom part number

Front Packaging (select one option)

- S** - Standard HID Artwork
- C** - Custom Artwork - Specify Custom Artwork Number¹

Back Packaging

- S** - Standard

Key Numbering¹ (select one option)

- M** - Sequential Matching Encoded/Printed (Inkjetted)⁴
- N** - No Printed Card Numbering
- S** - Sequential Encoded/Sequential Non-Matching Printed (Inkjetted)⁴
- R** - Random Encoded/Non-Matching Sequential Printed (Inkjetted)⁴
- A** - Sequential Matching Encoded/Printed (Laser Engraved)
- B** - Sequential Encoded/Sequential Non-Matching Printed (Laser Engraved)
- C** - Random Encoded/Non-Matching Sequential Printed (Laser Engraved)

Slot Punch²

- N** - None

Enter your final Key options from check boxes above. Example: 1434NSSNN

Final Part Number					S			N
-------------------	--	--	--	--	---	--	--	---



13.56 MHz Card Programming Information

Format Number	Field Name(s) e.g. Facility Code	Value	QTY	Encoded Start Number	Encoded Stop Number
				Printed Start Number	Printed Stop Number

¹ The Printed key number is placed on the back of the key.

² Key Ring sold separately (Part Number: 57-0001-02).

³ Includes a permanent Unique MIFARE 32 Bit Serial number.

⁴ Please note that cards shipped within the Americas are always laser-engraved. Inkjetted option is not available for these cards.

MIFARE Classic Adhesive Tag - 1435

Ensure each required option has been checked with the appropriate choice to fulfill a completed order form.

Base Model **1435 (1K)**

Programming (select one option)

- M** - Programmed with HID MIFARE⁶ access control application
- N** - Unprogrammed MIFARE Classic
- S** - Custom programmed MIFARE Classic, custom part number required

Front Packaging (select one option)

- S** - Standard HID Artwork
- C** - Custom Artwork - Specify Custom Artwork Number¹

Back Packaging

- S** - Standard

Tag Numbering¹ (select one option)

- M** - Sequential Matching Encoded/Printed (Inkjetted)
- N** - No Printed Card Numbering
- S** - Sequential Encoded/Sequential Non-Matching Printed (Inkjetted)
- R** - Random Encoded/Non-Matching Sequential Printed (Inkjetted)

Slot Punch²

- N** - None

Enter your final Tag options from check boxes above. Example: 1435NSSNN

Final Part Number					S			N
-------------------	--	--	--	--	---	--	--	---



13.56 MHz Card Programming Information

Format Number	Field Name(s) e.g. Facility Code	Value	QTY	Encoded Start Number	Encoded Stop Number
				Printed Start Number	Printed Stop Number

¹ The Printed tag number is placed on the back of the tag. In order to support laser marking technology HID will be transitioning from a white release paper to a black release paper. Please consult your sales Account Manager for more information.

² For new artwork files, contact Customer Service for custom artwork number, lead-times, minimum order quantities, and cost.

³ The Tag is not for use on cards that use full insertion or tractor feed type readers.

⁴ Includes a permanent Unique MIFARE 32 Bit Serial number.

* Up to 1.14in (29mm) read range in free air.

Do not adhere to metal surfaces. Metal shields the RF, making the tag inoperable. Due to variations in cards and reading devices, HID does not claim that the Tag will work in every situation. Functional and non-functional Tags are available for compatibility testing with existing credential and reader technologies. Compatibility should be confirmed prior to ordering.

* = Actual read range performance affected by mounting location, environment and the tags tuned resonant frequency.

CP1000 iCLASS SE Encoder

iCLASS SE Encoder Summary

The iCLASS SE Encoder Platform for encoding contactless credentials is:

- **Dynamic** - Support for a wide range of credential technologies, including Seos, iCLASS SE, iCLASS, HID Prox, MIFARE Classic, and MIFARE DESFire EV1 from single encoder.
- **Flexible** - Manage custom keys locally or leverage HID standard and Elite keys.
- **Convenient** - On-site programming of card stock speeds up the delivery time to obtain and issue cards.
- **Seamless** - Encode multi-tech credentials in a single pass, saving time and resources.

HID Global's iCLASS SE Encoder is an effective solution for organizations to encode credentials and configure readers. Highly versatile, the encoder can locally manage HID Global standard Keys, Elite Keys or securely define and manage custom keys. The dynamic iCLASS SE Encoder has the capability to encode and manage a wide variety of credential technologies, interoperable with iCLASS SE readers. The solution allows users to upgrade existing card populations for use with higher security iCLASS SE Platform readers. That same flexibility also supports new credential technologies as they arise.

The iCLASS SE Encoder is available either as a desktop device as the CP1000D, or as an in-line encoder within a FARGO® card printer. The in-line encoder enables organizations to graphically and electronically personalize 13.56 MHz and 125 kHz HID Prox cards in one seamless process, saving time and energy. This How to Order Guide will provide details for ordering credential credits, formats, and key for both the desktop and in-line encoder. Contact your local Fargo sales representative for in-line encoder information.

iCLASS SE Encoder - How Does it Work?

The iCLASS SE Encoder solution is made up of following components:

- **Hardware** - Encoder is available in either a desktop or in-line printer form factor
- **Software** - The encoder solution is compatible with two editions of Asure ID™:
 - **Asure ID CP1000 Edition** - This edition is included with the purchase of a desktop encoder (CP1000D) and is suitable for standalone desktop encoding. The solution enables data to be manually entered or to have it automatically increment after each encoded card.
 - **Asure ID Exchange Edition** - This edition is purchased separately and in addition to supporting the desktop encoder is the only edition which supports the in-line encoder. This solution can also connect to external databases in real-time when reading/encoding contactless cards.
- **Credential Credits** - The encoder utilizes credential credits to enable the encoding of contactless cards. The solution will decrement a credential credit each time a card has been encoded. Each credential technology and security combination will utilize a specific credential credit type (i.e. Seos card secured with an Elite key). Credential credit part numbers are allocated for Genuine HID or Third Party Credentials. The iCLASS SE Encoder is able to determine the source of the credential during the encoding cycle and will decrement the appropriate counter accordingly. Select encoder ready MIFARE Classic and MIFARE DESFire EV1 part numbers to avoid consuming a chargeable credit.
- **Formats** - Utilizes pre-defined format templates, eliminating the need to understand access control formatting and card numbering schemes. HID formats can be ordered using this HTOG but approval may be needed for proprietary formats.
- **Keysets** - Supports HID Elite, Standard, or Custom keys. Standard and HID Elite keys can be ordered using this HTOG but approval will be needed for HID Elite keys.

iCLASS SE Encoder Ordering Basics

The iCLASS SE Encoder is available for sale without a renewable lease agreement since it utilizes a credential credit process to encode cards. Follow the 5 steps below to ensure the correct hardware, encoding and configuration card credits, programming format and keys are ordered. If at any time you require assistance, contact your local HID Global sales or pre-sales representative.



Step 1: Hardware

Part Number: CP1000D

Contains:

- USB Desktop Encoder
- Installation Guide
- USB Flash Drive containing:
 - Asure ID CP1000 Desktop Application
 - Configuration package (*.ise file) that contains default credits, format H10301 (26-bit) and standard keys listed in the table below
 - User documentation
- The following credits, formats, and sample cards (included by default with every CP1000D) – if additional credits are needed, refer to Step 2 and add the required part numbers to the order form.

Credits Included		
Quantity	Part Number	Description
100,000	CRDT-K0	HID Prox Credential - Access Control
100,000	CRDT-A0	iCLASS Credential - Access Control
100,000	CRDT-A3	iCLASS SE Credential - Access Control
500,000	CRDT-A5	iCLASS Credential - Custom Data
30	CRDT-D3	Seos Credential - Access Control
30	CRDT-D5	Seos Credential - Custom Data
100,000	CRDT-B0	HID MIFARE Classic Credential - Access Control
100,000	CRDT-B3	HID MIFARE Classic Credential - Access Control (SIO)
500,000	CRDT-B5	HID MIFARE Classic Credential - Custom Data
100,000	CRDT-F5	Third Party MIFARE Classic Credential - Custom Data
100,000	CRDT-C3	HID MIFARE DESFire Credential - Access Control (SIO)
500,000	CRDT-C5	HID MIFARE DESFire Credential - Custom Data
100,000	CRDT-G5	Third Party MIFARE DESFire EV1 Credential - Custom Data
30	CRDT-J0	Configuration Card Generation

Formats Included	
Format	Description
H10301	26-bit (Facility code range 0-255, ID range 0-65535)

Sample Cards Included		
Quantity	Part Number	Description
2	1386NGGNB	HID Prox
2	2000CGGNN and 2003CGGNN	iCLASS 2k and 32k
2	3000VGGNN and 3003VGGNN	iCLASS SE 2k and 32k
3	5005VGGNN	Seos 16K
2	1430NGGNN and 1440NGGNN	MIFARE Classic 1K and 4k
2	1450CNGGNN	MIFARE DESFire EV1 8K
1	0501600475-READER	Reader Data Configuration Card (compatible with iCLASS SE Rev E)
1	0501600475-ELITE	HID Elite Prep Transport
1	2000PCCNN-LEGACY	iCLASS Legacy Transport

Step 2: Select Additional Credential Credits

The iCLASS SE Encoder utilizes credential credits to enable the encoding of contactless credentials. Each credential technology, security combination and programming data will utilize a specific credential credit. Credits are loaded and stored in the CP1000D USB desktop encoder hardware.

The iCLASS SE Encoder is able to determine the source of the credential during the encoding cycle and will decrement the appropriate credit counter accordingly. A reader compatibility list is provided for each credential credit table. Select encoder ready MIFARE Classic and MIFARE DESFire EV1 part numbers to avoid consuming a chargeable credit.

Genuine HID Technology Credential Credits – Part Tables

What Credential Credits do I need?

Select credits based on HID technology type and required programming. Some credits are chargeable, please refer to the current price list for details. Add the required part numbers to the order form.

Seos Technology	Key Type	Programming	Credit Part Number	Chargeable?
Seos	Standard	SIO	CRDT-D3	NO
Seos	HID Elite1	SIO	CRDT-D4	YES
Seos	Key Rolling	N/A	CRDT-D6	NO

iCLASS Technology	Key Type	Programming	Credit Part Number	Chargeable?
iCLASS SE (V type)	Standard	SIO	CRDT-A3	NO
iCLASS SE (V type)	HID Elite1	SIO	CRDT-A4	YES
iCLASS	Standard	Standard	CRDT-A0	NO
iCLASS	HID Elite1	Standard	CRDT-A1	YES
iCLASS	N/A	Custom Data	CRDT-A5	NO
iCLASS /iCLASS SE	Key Rolling	N/A	CRDT-A6	NO

MIFARE CLASSIC Technology	Key Type	Programming	Credit Part Number	Chargeable?
MIFARE CLASSIC (V Type)	Standard	SIO*	CRDT-B3	NO
MIFARE CLASSIC (V Type)	HID Elite1	SIO*	CRDT-B4	YES
MIFARE CLASSIC (V Type)	Standard	HID MIFARE	CRDT-B0	NO
MIFARE CLASSIC (V Type)	N/A	Custom Data	CRDT-B5	NO
MIFARE CLASSIC/ SIO for MIFARE CLASSIC	Key Rolling	N/A	CRDT-B6	NO

* Use encoder reader "V" type credentials only for SIO programming. Use of HID unprogrammed MIFARE CLASSIC cards will consume a chargeable third party credit.

125 kHz Technology	Key Type	Programming	Credit Part Number	Chargeable?
HID Prox	N/A	Standard	CRDT-K0	NO

MIFARE DESFire Technology	Key Type	Programming	Credit Part Number	Chargeable?
MIFARE DESFire (V Type)	Standard	SIO*	CRDT-C3	NO
MIFARE DESFire (V Type)	HID Elite1	SIO*	CRDT-C4	YES
MIFARE DESFire (V Type)	N/A	Custom Data	CRDT-C5	NO
MIFARE DESFire/ SIO for MIFARE DESFire	Key Rolling	N/A	CRDT-C6	NO

* Use encoder reader "V" type credentials only for SIO programming. Use of HID non-programmed MIFARE DESFire cards will consume a chargeable third party credit.

Configuration Card	Key Type	Programming	Credit Part Number	Chargeable?
SE Reader Configuration	N/A	Configuration Data	CRDT-J0	NO

¹ Authorization is required by the end user or owner of the HID Elite (formerly iCLASS Elite) keys before these can be released. Contact customer services for information on the authorization process.

Third Party HID Technology Credential Credits – Part Tables

What Credential Credits do I need?

Select credits based on the third party card technology. Most credits are chargeable but regional variations exist, please refer to the current price list for details. Add the required part numbers to the order form.

Note: Use of standard “N type” HID MIFARE Classic and MIFARE DESFire EV1 supplied cards will consume a chargeable credit. Order “V type” HID MIFARE Classic and MIFARE DESFire EV1 cards to avoid consuming a chargeable credit.

MIFARE CLASSIC Technology	Key Type	Programming	Credit Part Number	Chargeable?
MIFARE Classic	Standard	SIO	CRDT-F3	YES
MIFARE Classic	HID Elite1	SIO	CRDT-F4	YES
MIFARE Classic	Standard	HID MIFARE	CRDT-F0	See Price List
MIFARE Classic	N/A	Custom Data	CRDT-F5	See Price List

MIFARE DESFire Technology	Key Type	Programming	Credit Part Number	Chargeable?
MIFARE DESFire	Standard	SIO	CRDT-G3	YES
MIFARE DESFire	HID Elite1	SIO	CRDT-G4	YES
MIFARE DESFire	N/A	Custom Data	CRDT-G5	YES

Reader Compatibility Table

Credential Part Number	Reader Compatibility
CRDT-A0	HID Signo Readers (Smart, Standard and Custom credential profiles), iCLASS Rev A, B, C & iCLASS SE interpreter type “T” with keyset “0”
CRDT-A1	HID Signo Readers (Smart, Standard and Custom credential profiles), iCLASS Rev A, B, C & iCLASS SE interpreter type “T” and matching Elite ICE keyset
CRDT-A3, CRDT-B3, CRDT-C3, CRDT-D3, CRDT-F3, CRDT-G3, CRDT-H3	HID Signo Readers (Smart, Standard and Custom credential profiles), iCLASS SE readers only interpreter type “T” or “N” with keyset “0” or “2”
CRDT-A4, CRDT-B4, CRDT-C4, CRDT-D4, CRDT-F4, CRDT-G4, CRDT-H4	HID Signo Readers (Smart, Standard and Custom credential profiles), CLASS SE readers only interpreter type “T” or “N” with matching Elite ICE keyset
CRDT-A5	HID Signo Readers (Smart, Standard and Custom credential profiles), iCLASS Rev A, B, C & iCLASS SE
CRDT-F0 CRDT-B0	HID Signo Readers (Custom credential profile), HID 6055B, FlexSmart™ 6071/6072, Smart ID 8030DSHM/8031DSHM (HID MIFARE Only) and specific models of iCLASS SE.
CRDT-B5, CRD-C5, CRDT-F5, CRDT-G5	HID Signo Readers (Custom credential profile), iCLASS SE Migration readers only with matching custom key and mapper profile
CRDT-K0	HID Signo Readers (Standard and Custom credential profiles), HID Prox compatible readers including multiCLASS

¹ Authorization is required by the end user or owner of the HID Elite (formerly iCLASS Elite) keys before these can be released. Contact customer services for information on the authorization process.

Step 3: Select Additional Formats

The iCLASS SE Encoder supports a wide range of HID formats; by default every encoder is supplied with H10301, the HID open 26-bit format with full facility code and ID range. Use this section as a guide to order additional HID open/tracked, Corporate 1000 or OEM formats. Add the required part number and details to the order form.

Format Part Number	Format Type
FRMT-J1	HID open/tracked or OEM formats
FRMT-J2	HID Corporate 1000 formats

Tracked ID Number Ranges

If you order a tracked format for example Corporate 1000, H10302 or H10304 the next available number range is automatically assigned. A limit of 10,000 ID numbers per order applies to H10302.

Read Only

If you have a requirement for format read-only functionality for example, to read the encoded format as part of the printing process, order the required format with a card ID range of one number. The availability of the format on the encoder provides read-only functionality for the entire format ID range and variable field values.

How to order FRMT-J1 (HID open, tracked or OEM format)

Example 1:

- I want to order H10301 (HID open 26-bit with facility code and number range)
- I want facility code 99
- I want 500 numbers starting at 1,001

Part Number	Format Number	Field Name(s) e.g. Facility Code	Value	Start Number	Quantity
FRMT-J1	H10301	Facility Code	99	1,001	500

Example 2:

- I want to order H10304 (HID tracked 37-bit with reserved facility code)
- I want facility code 99
- I want 1,000 numbers (since H10304 is tracked, the next available numbers will be allocated)

Part Number	Format Number	Field Name(s) e.g. Facility Code	Value	Start Number	Quantity
FRMT-J1	H10304	Facility Code	99	N/A	500

How to order FRMT-J2 (Corporate 1000 format)

Example

- I want to order a Corporate 1000 format
- I want 10,000 numbers (since Corporate 1000 formats are tracked, the next available numbers will be allocated)

Part Number	Format Number	Company ID Code Value	Start Number	Quantity
FRMT-J2	H2004095	4095	N/A	10,000

Step 4: Select Additional Keysets

Key Management is a complex subject that requires some understanding of the various technologies and how smart card applications are managed. For example, encoding data on an iCLASS or MIFARE Classic card requires, at a minimum, a single authentication key to gain access to the application area or sector. The application data may have additional security enhancements requiring additional keys. The HID Application for example, requires two DES keys, one key for authentication to the app area and another key for encryption of the application data, while the Secure Identity Object (SIO) requires AES keys for encryption and signing the credential. Each technology will differ in terms of the keys that need to be created and managed. The iCLASS SE Encoder includes utilities for managing individual keys as well as grouping those keys into key sets for ease of deployment.

To ensure your iCLASS SE Encoder is equipped with the correct keys it is necessary to order keysets appropriately. There are three classes of keysets available which are explained below.

Media Keyset

Media keysets provide all the cryptographic keys necessary to set up and encode cards. The keys delivered with each part number will vary depending on the needs of the technology. For instance part number CKEYMED-ICL-0 will deliver the iCLASS media Keyset for accessing the HID application area, the encryption key for the PACS data, and the key for accessing the SE application area. If you are using HID Elite Credentials, the part number will be CKEYMED-ICL-1.

Part number CKEYMED-MIF-n will deliver Key A and Key B for accessing the HID application on a MIFARE Classic card as well as transport keys for the MAD (MIFARE Application Directory).

Part number CKEYMED-DES-n will deliver keys for accessing the HID application on a MIFARE DESFire EV1 card including the PICC master key, the application master key and the application read and write keys.

Reader Configuration Keyset

The Reader configuration keyset provides the privacy and authentication keys necessary to create configuration cards. Typically, configuration cards are needed to push new keys and/or configuration data to the reader. In order to utilize this solution, it is necessary to order programmable configuration cards.

Part numbers for these cards are:

- **0501600475-READER** - used for reader configuration
- **0501600475-ELITE** - used for HID Elite key preparation.

SIO Keyset

The SIO Keyset provides the privacy and authentication keys for HID's Secure Identity Objects. Because SIOs are independent of card technology, their keys are ordered separately.

Default Keysets

The iCLASS SE Encoder is delivered with the following standard Keysets:

Keysets	Security	Credit Part Number
Seos Media Keyset	HID Standard	CKEYMED-SEOS-0
iCLASS Media Keyset	HID Standard	CKEYMED-ICL-0
MIFARE Classic Media Keyset	HID Standard	CKEYMED-MIF-0
MIFARE DESFire Media Keyset	HID Standard	CKEYMED-DES-0
Reader Configuration Keyset	HID Standard	CKEYCFG-0
SIO Keyset	HID Standard	CKEYSIO-0

Additional HID Elite Keysets

Select the appropriate additional HID Elite keyset to encode HID or third party credentials or generate configuration cards with an HID Elite key. All HID Elite keysets are free of charge, however a suitable HID Elite credential credit is required to encode credentials with an HID Elite key. Add the required part number to the order form.

Keysets	Security	Keyset Part Number	Chargeable?
Seos Media Keyset	HID Elite	CKEYMED-SEOS-1	NO
iCLASS Media Keyset	HID Elite	CKEYMED-ICL-1	NO
MIFARE Classic Media Keyset	HID Elite	CKEYMED-MIF-1	NO
MIFARE DESFire Media Keyset	HID Elite	CKEYMED-DES-1	NO
Reader Configuration Keyset	HID Elite	CKEYCFG-1	NO



Step 5: Encoder Order Form

Complete the order form and submit it to your local HID Global order processing team

Hardware		
Part Number	Description	QTY
CP1000D	CP1000D USB encoder with H10301, standard keys and default credits	

Existing CP1000 Serial Number – [Only required to order formats, credits and keysets for an existing encoder]	
Serial Number (found on underside of USB device or inside door/bottom of printer):	CP

Additional Credits	
Part Number	QTY
CRDT-	
CRDT-	
CRDT-	
CRDT-	
CRDT-	

Additional Open, Tracked of OEM Formats ^{1,2} Note: A limit of 10,000 numbers per order applies to format H10302					
Part Number	Format Number	Field Names	Value	ID Start Number	QTY
FRMT-J1					

Part Number	Format Number	Field Names	Value	ID Start Number	QTY
FRMT-J1					

Part Number	Format Number	Field Names	Value	ID Start Number	QTY
FRMT-J1					

Additional Corporate 1000 Formats ^{3,4}			
Part Number	Format Number	Company ID Code	QTY
FRMT-J2			
FRMT-J2			
FRMT-J2			

Additional HID Elite Media Keysets ⁵		
Part Number	ICE Key #	QTY
CKEYMED- -1		1
CKEYMED- -1		1
CKEYMED- -1		1

Additional HID Elite Reader Configuration Keyset ^{6,7}		
Part Number	ICE Key #	QTY
CKCFG- -1		1
CKCFG- -1		1
CKCFG- -1		1

¹ OEM formats required owner authorization, H10304 facility codes are registered to a specific account. Contact customer services for information on the authorization process.

² HID open formats such as H10301 and H10320 requires the customer to specify the required number range. HID does not track open formats.

³ HID open, tracked formats such as H10302 and H10304 are tracked by HID, duplicates are not allowed.

⁴ Authorization is required by the end user authorized contacts. Contact customer services for information on the authorization process.

⁵ Corporate 1000 number ranges ordered for the CP1000 will not be available for future physical card orders.

^{6,7} Authorization is required by the end user or owner of the HID Elite (formerly iCLASS Elite) keys before these can be released. Contact customer services for information on the authorization process.

Embeddable Credentials

Overview

What is an Embeddable Card?

HID's Embeddable Cards offers customers an ISO Standard product that can be embedded with a contact chip according to ISO/IEC 7816 specifications. Contactless credential technologies such as Seos, iCLASS SE, iCLASS and Prox can be provided in an embeddable credential to ensure interoperability. If you would like to specify a card with both Contact and Contactless technologies please visit the Crescendo How to Order Guide.

Why do I need an Embeddable Card?

Embeddable Cards enable the option of adding a contact chip, when coupled with a system of contact chip readers they can be used to provide additional security to protect access to personal computers, IT networks, and data. Contact chip based solutions can facilitate faster data transactions, meaning higher levels of encryption can be used without compromising the overall transaction time, they can also be used for secure access to physical spaces and facilities. Embeddable Cards are manufactured to a very specific set of tolerances designed to accept a contact chip without compromising card integrity.

Can I Configure my Embeddable Credential Product Online?

Yes, HID Global® is now offering the HID Global Product Configurator. This online tool will guide customers and partners toward the most suitable product for their needs. There are two main features available with this tool:

- **Find by part number** – allows customers to enter an existing part number to see the specification of this credential.
- **Build a credential** – helps customers construct a complete part number, including keyset and formatting information; everything needed to place an order. Customers will be able to download a PDF with all specifications of the credential they build to allow for a smooth ordering process.

HID Global Product Configurator: <https://www.hidglobal.com/configure>

Credentials Marking

For information on Card Identification Markings, please see *HID Global Credential Identification Markings Application Note (AN0109)*.

Embedding Capability

All Cards should be embedded on the Front Only. If the Partner/End User wishes to embed on the back of the card, please note that a custom part number would be required.

For other Credential information click on the links below:

- [What should I know about security keysets?](#)
- [How can I order HID Elite configured credentials?](#)
- [How can I migrate from my current credential technology?](#)
- [Understanding Credential Formats](#)
- [Understanding Credential Programming](#)

Embeddable Seos Credentials

Seos Embeddable Card - 501

Increased security and interoperability cards for installation supporting HID Signo and iCLASS SE reader platform

Ensure each required option has been checked with the appropriate choice to fulfill a completed order form.

Base Model **501 Composite 40% Polyester / PVC 60%**

Seos Memory Size and Allocation

- 5 - 16K Bytes
- 6 - 8K Bytes

Secure Identity Object Programming

- P - Programmed with Security Identity Object (SIO)
- V - Unprogrammed, for use with iCLASS SE Encoder

Front Packaging (select one option)

- G - Plain White with Gloss Finish
- C - Custom Artwork with Gloss Finish – Specify Custom Artwork Number¹

Back Packaging (select one option)

- G - Plain White with Gloss Finish²
- C - Custom Artwork with Gloss Finish – Specify Custom Artwork Number¹
- 1 - Plain White with Gloss Finish with Magnetic Stripe²
- 3 - Custom Artwork with Gloss Finish with Magnetic Stripe - Specify Custom Artwork Number¹

Card Numbering³ (select one option)

- N - No External Card Numbering
- A - Sequential Matching Internal/External (Laser Engraved)
- B - Sequential Internal/Sequential Non-Matching External (Laser Engraved)
- C - Random Internal/Non-Matching Sequential External (Laser Engraved)

Slot Punch

- N - No Slot Punch

Option - Custom Artwork¹

- _____ (Specify Artwork Number - Refer to the Custom Artwork Forms for new Artwork)

Enter your final card options from check boxes above. Example: 5015PGN

Final Part Number	501		P			N		-	(Options #)
-------------------	-----	--	---	--	--	---	--	---	-------------

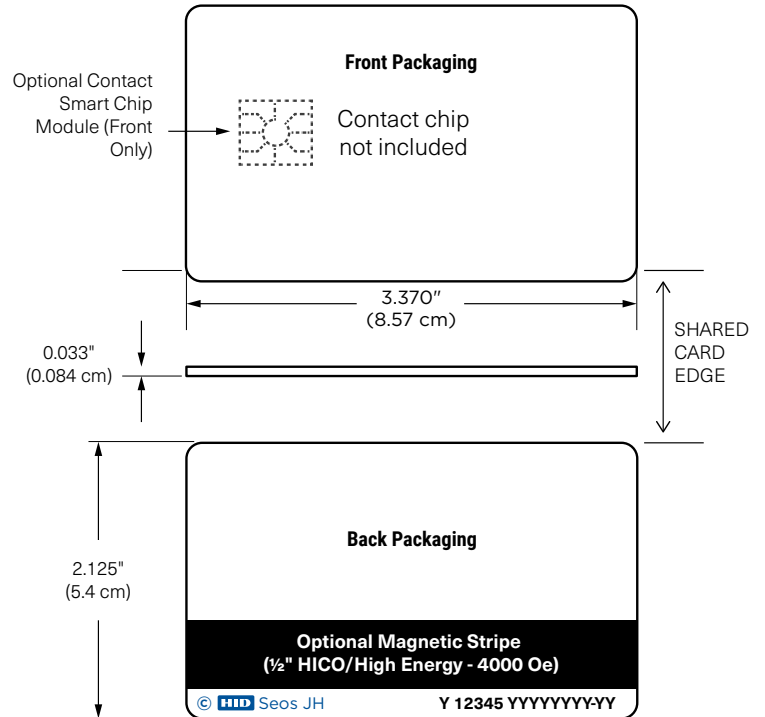

Y = Seos Programming
12345 = Card ID Number
YYYYYYY-YY = Sales Order Number
Sales Order is a variable length



Seos Card Programming Information

Format Number (e.g. H10301)	Field Name(s) e.g. Facility Code	Value	QTY	Encoded Start Number	Encoded Stop Number
Bit Numbers (e.g. 26 bit)				Printed Start Number	Printed Stop Number
ICE Number					
Special Instructions:					

For Contact Smart Chip selection, contact your Regional Sales Representative. Standard configuration does not include a contact smart chip module.

¹ For new artwork files, contact Customer Service for custom artwork number, lead-times, and cost.

² Cards ordered with plain white front and back packaging, or custom artwork, will still have a small HID logo  and reference number printed in the lower left-hand corner and a slot punch target printed on the back of the card.

³ The external card number is placed in the bottom right-hand corner on the back of the card.

⁴ Available with 7 byte static UID for ISO14443A UID migration and interoperability. This feature reduces privacy and is not recommended. Contact your local sales or pre-sales representative for detail.

Seos + Prox Embeddable Card - 511

Migration solution from proximity to high security for support in HID Signo or iCLASS SE reader platform.

Ensure each required option has been checked with the appropriate choice to fulfill a completed order form.

Base Model **511 Composite 40% Polyester / PVC**

Seos Memory Size and Allocation

- 5** - 16K Bytes
- 6** - 8K Bytes

Secure Identity Object Programming (select one option)

- P** - Programmed with Security Identity Object (SIO), Prox non programmed
- R** - Both interfaces programmed: Seos with Security Identity Object (SIO), Prox programmed with HID format
- V** - Unprogrammed, for use with iCLASS SE Encoder

Front Packaging (select one option)

- G** - Plain White with Gloss Finish
- C** - Custom Artwork with Gloss Finish - Specify Custom Artwork Number¹

Back Packaging (select one option)

- G** - Plain White with Gloss Finish²
- C** - Custom Artwork with Gloss Finish - Specify Custom Artwork Number¹
- 1** - Plain White with Gloss Finish with Magnetic Stripe²
- 3** - Custom Artwork with Gloss Finish with Magnetic Stripe - Specify Custom Artwork Number¹

13.56 MHz iCLASS Card Numbering³ (select one option)

- N** - No External Card Numbering
- A** - Sequential Matching Internal/External (Laser Engraved)
- B** - Sequential Internal/Sequential Non-Matching External (Laser Engraved)
- C** - Random Internal/Non-Matching Sequential External (Laser Engraved)

Slot Punch

- N** - No Slot Punch

125 kHz Card Numbering³ (select one option)

- N** - No External Card Numbering
- A** - Sequential Matching Internal/External (Laser Engraved)
- B** - Sequential Internal/Sequential Non-Matching External (Laser Engraved)
- C** - Random Internal/Non-Matching Sequential External (Laser Engraved)

Option - Custom Artwork¹

- _____ (Specify Artwork Number - Refer to the Custom Artwork Forms for new Artwork)

Enter your final card options from check boxes above. Example: 5015PGNN

Final Part Number	511						N		-	(Options #)
-------------------	-----	--	--	--	--	--	---	--	---	-------------

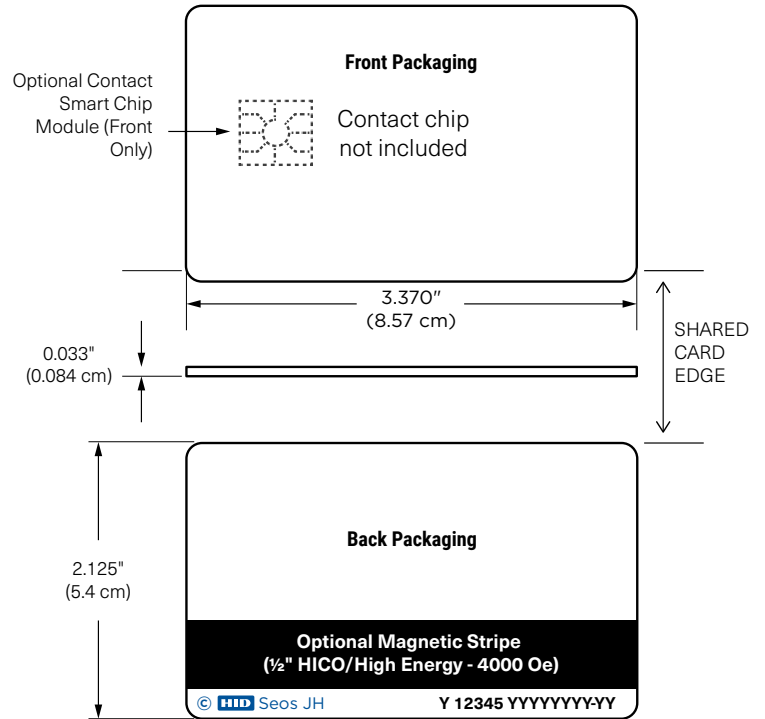

Y = Seos Programming
12345 = Card ID Number
YYYYYYYY-YY = Sales Order Number
Sales Order is a variable length



Seos Card Programming Information

Format Number (e.g. H10301)	Field Name(s) e.g. Facility Code	Value	QTY	Encoded Start Number	Encoded Stop Number
Bit Numbers (e.g. 26 bit)				Printed Start Number	Printed Stop Number
ICE Number					

125 kHz Programming Information

Format Number (e.g. H10301)	Field Name(s) e.g. Facility Code	Value	QTY	Encoded Start Number	Encoded Stop Number
Bit Numbers (e.g. 26 bit)				Printed Start Number	Printed Stop Number

Special Instructions:	
------------------------------	--

For Contact Smart Chip selection, contact your Regional Sales Representative. Standard configuration does not include a contact smart chip module.

¹ For new artwork files, contact Customer Service for custom artwork number, lead-times, and cost.

² Cards ordered with plain white front and back packaging, or custom artwork, will still have a small HID logo  and reference number printed in the lower left-hand corner and a slot punch target printed on the back of the card.

³ The external card number is placed in the bottom right-hand corner on the back of the card.

⁴ Available with 7 byte static UID for ISO14443A UID migration and interoperability. This feature reduces privacy and is not recommended. Contact your local sales or pre-sales representative for detail.

Embeddable iCLASS SE Credentials

iCLASS SE Embeddable Card - 301

These embeddable cards offer heightened security for installations that do not contain standard iCLASS credentials. This card is SIO only, it is not loaded with standard data payload and for this reason is not compatible with non iCLASS SE readers.

Ensure each required option has been checked with the appropriate choice to fulfill a completed order form.

Base Model **301 Composite 40% Polyester / PVC***

iCLASS Memory Size and Allocation (select one option)

- 0 - 2k Bits (256 Bytes) with 2 Application Areas
- 3 - 32k Bits (4K Bytes) Application areas 16k/2+16k/1
- 4 - 32k Bits (4K Bytes) Application areas 16k/16+16k/1

Secure Identity Object Programming

- P - Programmed with Security Identity Object (SIO)
- V - Unprogrammed, for use with iCLASS SE Encoder

Front Packaging (select one option)

- G - Plain White with Gloss Finish²
- C - Custom Artwork with Gloss Finish – Specify Custom Artwork Number¹

Back Packaging (select one option)

- G - Plain White with Gloss Finish²
- C - Custom Artwork with Gloss Finish – Specify Custom Artwork Number¹
- 1 - Plain White with Gloss Finish with Magnetic Stripe²
- 3 - Custom Artwork with Gloss Finish with Magnetic Stripe - Specify Custom Artwork Number¹

Card Numbering³ (select one option)

- N - No External Card Numbering
- A - Sequential Matching Internal/External (Laser Engraved)
- B - Sequential Internal/Sequential Non-Matching External (Laser Engraved)
- C - Random Internal/Non-Matching Sequential External (Laser Engraved)

Slot Punch⁴ (select one option)

- N - No Slot Punch (Printed location of vertical slot punch will remain)
- V - Vertical Slot Punch
- B - No Slot Punch - Horizontal Punch compatible (Printed location of Vertical and Horizontal slot punch will remain)⁵
- H - Horizontal Slot Punch⁵

Option - Custom Artwork¹

_____ (Specify Artwork Number - Refer to the Custom Artwork Forms for new Artwork)

Enter your final card options from the above selections. Example: 3014PGGAN

Final Part Number		P						-	(Options #)
-------------------	--	---	--	--	--	--	--	---	-------------

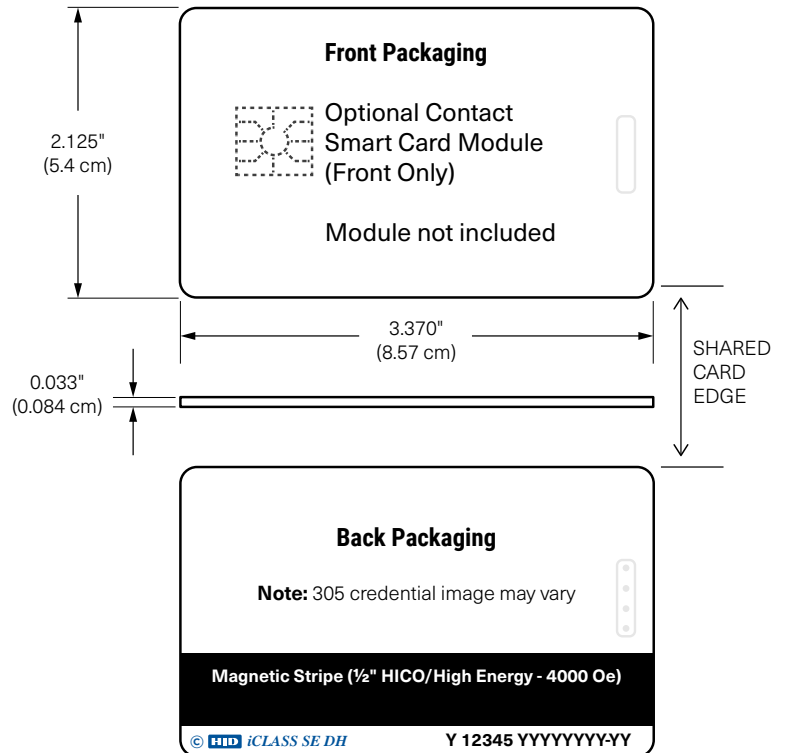

Y = iCLASS Programming
12345 = Card ID Number
YYYYYYY-YY = Sales Order Number



iCLASS Card Programming Information

Format Number (e.g. H10301)	Field Name(s) e.g. Facility Code	Value	QTY	Encoded Start Number	Encoded Stop Number
Bit Numbers (e.g. 26 bit)				Printed Start Number	Printed Stop Number
ICE Number					
Special Instructions:					

- ¹ For new artwork files, contact Customer Service for custom artwork number, lead-times, and cost.
- ² Cards ordered with plain white front and back packaging, or custom artwork, will still have a small HID logo and reference number printed in the lower left-hand corner and a slot punch target printed on the back of the card.
- ³ The external card number is placed in the bottom right-hand corner on the back of the card.
- ⁴ Cards are provided with an optional slot punch at no additional charge. Some video imaging printers cannot accommodate pre-slot punched cards.
- ⁵ The ability to add a horizontal slot punch requires a different iCLASS antenna design. Users can expect a read range reduction of approximately 20% if they order options B or H for the Slot Punch.
- * The composite construction is recommended for all cards with over-laminate applied. Consult with the printer manufacturer prior to ordering.



iCLASS SE + Prox Embeddable Card - 311

Maximized compatibility with added security into installations that DO contain standard Prox credentials. This card is SIO only, it is not loaded with standard data payload and for this reason is not compatible with non iCLASS SE readers.

Ensure each required option has been checked with the appropriate choice to fulfill a completed order form.

Base Model **311 Composite 40% Polyester / PVC***

iCLASS Memory Size and Allocation (select one option)

- 0** - 2k Bits (256 Bytes) with 2 Application Areas
- 3** - 32k Bits (4K Bytes) Application areas 16k/2+16k/1
- 4** - 32k Bits (4K Bytes) Application areas 16k/16+16k/1

Secure Identity Object Programming (select one option)

- P** - Programmed with Security Identity Object (SIO), Prox non programmed
- R** - Both interfaces programmed: iCLASS with Security Identity Object (SIO), Prox programmed with HID format

Front Packaging (select one option)

- G** - Plain White with Gloss Finish²
- C** - Custom Artwork with Gloss Finish - Specify Custom Artwork Number¹

Back Packaging (select one option)

- G** - Plain White with Gloss Finish²
- C** - Custom Artwork with Gloss Finish - Specify Custom Artwork Number¹
- 1** - Plain White with Gloss Finish with Magnetic Stripe²
- 3** - Custom Artwork with Gloss Finish with Magnetic Stripe - Specify Custom Artwork Number¹

13.56 MHz iCLASS Card Numbering³ (select one option)

- N** - No External Card Numbering
- A** - Sequential Matching Internal/External (Laser Engraved)
- B** - Sequential Internal/Sequential Non-Matching External (Laser Engraved)
- C** - Random Internal/Non-Matching Sequential External (Laser Engraved)

Slot Punch⁴ (select one option)

- N** - No Slot Punch (Printed location of vertical slot punch will remain)
- V** - Vertical Slot Punch

125 kHz Card Numbering³ (select one option)

- N** - No External Card Numbering
- A** - Sequential Matching Internal/External (Laser Engraved)
- B** - Sequential Internal/Sequential Non-Matching External (Laser Engraved)
- C** - Random Internal/Non-Matching Sequential External (Laser Engraved)

Option - Custom Artwork¹

- _____ (Specify Artwork Number - Refer to the Custom Artwork Forms for new Artwork)

Enter your final card options from check boxes above. Example: 3114PGNNNN

Final Part Number		P						-	(Options #)
-------------------	--	---	--	--	--	--	--	---	-------------

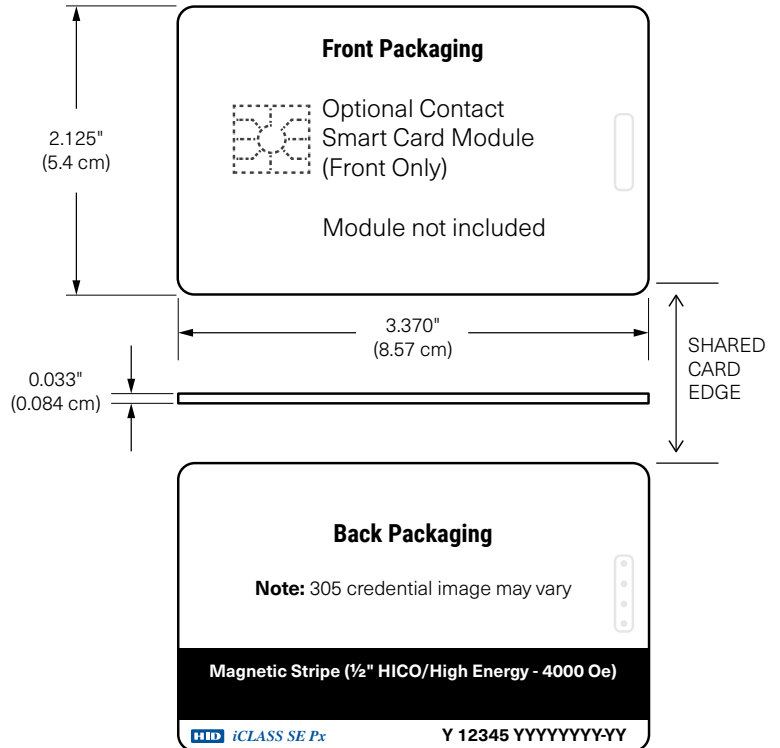

Y = iCLASS Programming
12345 = Card ID Number
YYYYYYY-YY = Sales Order Number



iCLASS Card Programming Information

Format Number (e.g. H10301)	Field Name(s) e.g. Facility Code	Value	QTY	Encoded Start Number	Encoded Stop Number
Bit Numbers (e.g. 26 bit)				Printed Start Number	Printed Stop Number
ICE Number					

125 kHz Card Programming Information

Format Number (e.g. H10301)	Field Name(s) e.g. Facility Code	Value	QTY	Encoded Start Number	Encoded Stop Number
Bit Numbers (e.g. 26 bit)				Printed Start Number	Printed Stop Number

Special Instructions:	
------------------------------	--

¹ For new artwork files, contact Customer Service for custom artwork number, lead-times, and cost.

² Cards ordered with plain white front and back packaging, or custom artwork, will still have a small HID logo  and reference number printed in the lower left-hand corner and a slot punch target printed on the back of the card.

³ The external card number is placed in the bottom right-hand corner on the back of the card.

⁴ Cards are provided with an optional slot punch at no additional charge. Some video imaging printers cannot accommodate pre-slot punched cards.

* The composite construction is recommended for all cards with over-laminate applied. Consult with the printer manufacturer prior to ordering.

iCLASS SE + Other HF Embeddable Card - 392

The SIO-Enabled iCLASS with MIFARE or MIFARE DESFire embeddable smart card offers multiple High Frequency technologies to simplify card issuance for diverse systems or migration projects.

This card offers maximized compatibility with added security into installations that do not contain standard iCLASS or MIFARE/MIFARE DESFire credentials.

Ensure each required option has been checked with the appropriate choice to fulfill a completed order form.

Base Model **392 Composite 40% Polyester / PVC***

iCLASS Memory Size and Allocation (select one option)

- 0** - 2k Bits (256 Bytes) with 2 Application Areas
(only available with MIFARE CLASSIC 1K)
- 3** - 32k Bits (4K Bytes) Application areas 16k/2+16k/1
- 4** - 32k Bits (4K Bytes) Application areas 16k/16+16k/1

Card Programming (select one option)

- R** - iCLASS programmed with Secure Identity Object (SIO), 2nd Technology programmed with Secure Identity Object (SIO).
- P** - iCLASS programmed with Secure Identity Object (SIO), 2nd Technology unprogrammed for use with iCLASS SE encoder (HID MIFARE or custom encoding).
- K** - iCLASS programmed with Secure Identity Object (SIO), 2nd Technology programmed with HID MIFARE Classic or custom MIFARE Classic (option M or N 2nd HF only).
- A** - iCLASS unprogrammed for use with iCLASS SE Encoder, 2nd Technology programmed with Secure Identity Object (SIO).
- B** - iCLASS unprogrammed for use with iCLASS SE Encoder, 2nd Technology unprogrammed for use with iCLASS SE encoder (HID MIFARE or custom encoding).
- V** - iCLASS unprogrammed for use with iCLASS SE Encoder, 2nd Technology unprogrammed for use with iCLASS SE encoder (SIO, HID MIFARE or custom encoding).

2nd High Frequency Technology (select one option)

- M** - MIFARE 1K Bytes (only available with iCLASS 2k bits)
- N** - MIFARE 4K Bytes

Front Packaging (select one option)

- G** - Plain White with Gloss Finish
- C** - Custom Artwork with Gloss Finish – Specify Custom Artwork Number¹

Back Packaging (select one option)

- G** - Plain White with Gloss Finish²
- C** - Custom Artwork with Gloss Finish – Specify Custom Artwork Number¹
- 1** - Plain White with Gloss Finish with Magnetic Stripe²
- 3** - Custom Artwork with Gloss Finish with Magnetic Stripe - Specify Custom Artwork Number¹

iCLASS Card Numbering³ (select one option)

- N** - No External Card Numbering
- A** - Sequential Matching Internal/External (Laser Engraved)
- B** - Sequential Internal/Sequential Non-Matching External (Laser Engraved)
- C** - Random Internal/Non-Matching Sequential External (Laser Engraved)

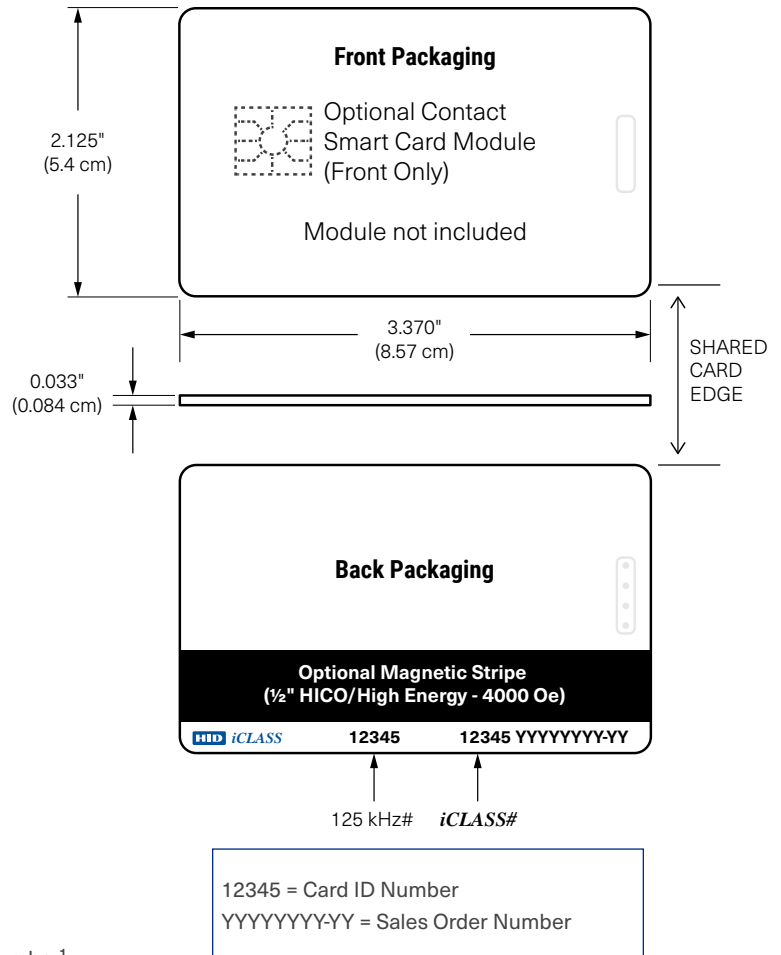



Slot Punch

IMPORTANT: Dual High Frequency credentials do not allow a slot punch due to the antenna design. Use a badge holder to attach this card to a lanyard or badge clip.

N - No Slot Punch

2nd High Frequency Technology Card Numbering³ (select one option)

- N - No External Card Numbering
- A - Sequential Matching Internal/External (Laser Engraved)
- B - Sequential Internal/Sequential Non-Matching External (Laser Engraved)
- W - UID (CSN) HEX numbering only (Engraved): 7 bytes UID⁴
- X - UID (CSN) Decimal numbering only (Engraved): 7 bytes UID⁴

Option - Custom Artwork¹

_____ (Specify Artwork Number - Refer to the Custom Artwork Forms for new Artwork)

Enter your final card options from check boxes above. Example: 3924PNGGANN

Final Part Number	392							N		-	(Options #)
-------------------	-----	--	--	--	--	--	--	---	--	---	-------------

iCLASS Programming Information

Format Number (e.g. H10301)	Field Name(s) e.g. Facility Code	Value	QTY	Encoded Start Number	Encoded Stop Number
Bit Numbers (e.g. 26 bit)				Printed Start Number	Printed Stop Number
ICE Number					

2nd 13.56 MHz Programming Information

Format Number (e.g. H10301)	Field Name(s) e.g. Facility Code	Value	QTY	Encoded Start Number	Encoded Stop Number
Bit Numbers (e.g. 26 bit)				Printed Start Number	Printed Stop Number
ICE Number					

Special Instructions: _____

¹ For new artwork files, contact Customer Service for custom artwork number, lead-times, and cost.

² Cards ordered with plain white front and back packaging, or custom artwork, will still have a small HID logo and reference number printed in the lower left-hand corner and a slot punch target printed on the back of the card.

³ The external card number is placed in the bottom right-hand corner for iCLASS 13.56 MHz and in the bottom center for the second technology on the back of the card.

⁴ MIFARE Classic UID length is by default 4 bytes, 7 bytes for MIFARE DESFire EV1.

* The composite construction is recommended for all cards with over-laminate applied. Consult with the printer manufacturer prior to ordering.

iCLASS SE + Other 13.56MHz + Prox Embeddable Card - 397

The SIO-enabled card with MIFARE or MIFARE DESFire embeddable smart card as well as HID Proximity offers multiple High Frequency technologies to simplify card issuance for diverse systems or migration projects.

This card offers maximized compatibility with added security into installations that DO not contain standard iCLASS or MIFARE/MIFARE DESFire credentials.

Ensure each required option has been checked with the appropriate choice to fulfill a completed order form.

Base Model **397 Composite 40% Polyester / PVC***

iCLASS Memory Size and Allocation (select one option)

- 0** - 2k Bits (256 Bytes) with 2 Application Areas (only available with MIFARE CLASSIC 1K)
- 3** - 32k Bits (4K Bytes) Application areas 16k/2+16k/1
- 4** - 32k Bits (4K Bytes) Application areas 16k/16+16k/1

13.56 MHz Technology Card Programming (select one option)

- R** - iCLASS programmed with Secure Identity Object (SIO), 2nd Technology programmed with Secure Identity Object (SIO).
- P** - iCLASS programmed with Secure Identity Object (SIO), 2nd Technology unprogrammed for use with iCLASS SE encoder (HID MIFARE or custom encoding).
- A** - iCLASS unprogrammed for use with iCLASS SE Encoder, 2nd Technology programmed with Secure Identity Object (SIO).
- V** - iCLASS unprogrammed for use with iCLASS SE Encoder, 2nd Technology unprogrammed for use with iCLASS SE encoder (SIO, HID MIFARE or custom encoding).

2nd High Frequency (13.56 MHz) Technology (select one option)

- M** - MIFARE 1K Bytes (only available with iCLASS 2k bits)
- N** - MIFARE 4K Bytes

125 kHz Technology Card Programming (select one option)

- P** - "HID Prox" Programmed 125 kHz Technology. Specify Programming Information.
- C** - "Indala/Casi Prox" Programmed 125 kHz Technology. Specify Programming Information.
- N** - Initialized 125 kHz Technology. Programming Information Not Required.

Front Packaging (select one option)

- G** - Plain White with Gloss Finish
- C** - Custom Artwork with Gloss Finish – Specify Custom Artwork Number¹

Back Packaging (select one option)

- G** - Plain White with Gloss Finish²
- C** - Custom Artwork with Gloss Finish – Specify Custom Artwork Number¹
- 1** - Plain White with Gloss Finish with Magnetic Stripe²
- 3** - Custom Artwork with Gloss Finish with Magnetic Stripe - Specify Custom Artwork Number¹

iCLASS Card Numbering³ (select one option)

- N** - No External Card Numbering
- A** - Sequential Matching Internal/External (Laser Engraved)
- B** - Sequential Internal/Sequential Non-Matching External (Laser Engraved)
- C** - Random Internal/Non-Matching Sequential External (Laser Engraved)

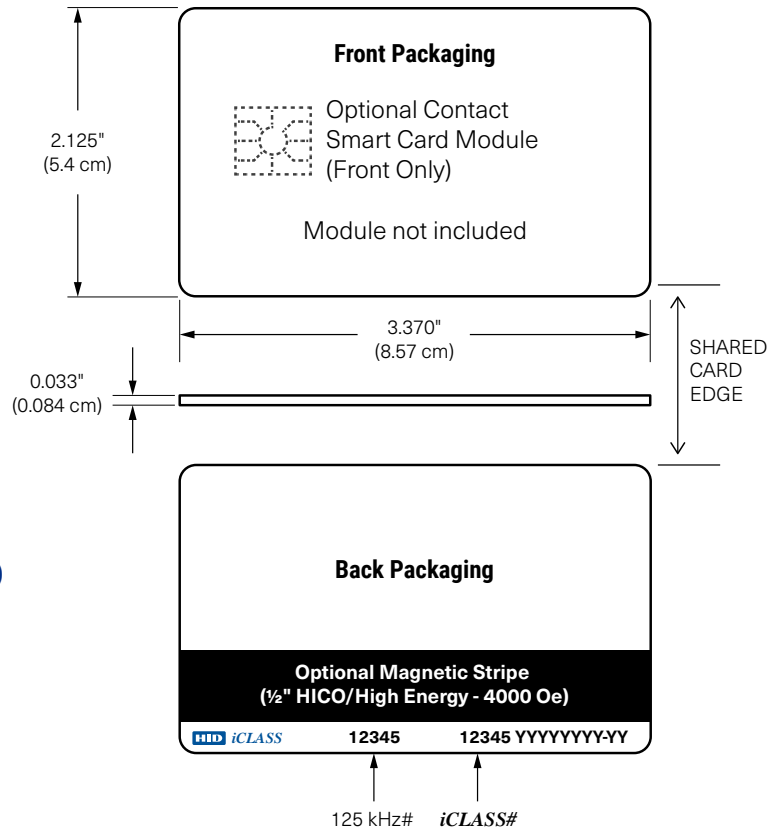

12345 = Card ID Number
YYYYYYYY-YY = Sales Order Number



Slot Punch

IMPORTANT: Dual High Frequency credentials do not allow a slot punch due to the antenna design. Use a badge holder to attach this card to a lanyard or badge clip.

N - No Slot Punch

2nd High Frequency Technology Card Numbering³ (select one option)

- N - No External Card Numbering
- A - Sequential Matching Internal/External (Laser Engraved)
- B - Sequential Internal/Sequential Non-Matching External (Laser Engraved)
- C - Random Internal/Non-Matching Sequential External (Laser Engraved)
- W - UID (CSN) HEX numbering only (Engraved): 7 bytes UID⁴
- X - UID (CSN) Decimal numbering only (Engraved): 7 bytes UID⁴

125 kHz Card Numbering³ (select one option)

- N - No External Card Numbering
- A - Sequential Matching Internal/External (Laser Engraved)
- B - Sequential Internal/Sequential Non-Matching External (Laser Engraved)
- C - Random Internal/Non-Matching Sequential External (Laser Engraved)

Option - Custom Artwork¹

_____ (Specify Artwork Number - Refer to the Custom Artwork Forms for new Artwork)

Enter your final card options from check boxes above. Example: 3974PNPGGNNA

Final Part Number								N		-	(Options #)
-------------------	--	--	--	--	--	--	--	---	--	---	-------------

iCLASS Programming Information

Format Number (e.g. H10301)	Field Name(s) e.g. Facility Code	Value	QTY	Encoded Start Number	Encoded Stop Number
Bit Numbers (e.g. 26 bit)				Printed Start Number	Printed Stop Number
ICE Number					

2nd 13.56 MHz Programming Information

Format Number (e.g. H10301)	Field Name(s) e.g. Facility Code	Value	QTY	Encoded Start Number	Encoded Stop Number
Bit Numbers (e.g. 26 bit)				Printed Start Number	Printed Stop Number
ICE Number					



125 kHz Programming Information

Format Number (e.g. H10301)	Field Name(s) e.g. Facility Code	Value	QTY	Encoded Start Number	Encoded Stop Number
Bit Numbers (e.g. 26 bit)				Printed Start Number	Printed Stop Number
ICE Number					

¹ For new artwork files, contact Customer Service for custom artwork number, lead-times, and cost.

² Cards ordered with plain white front and back packaging, or custom artwork, will still have a small HID logo  and reference number printed in the lower left-hand corner and a slot punch target printed on the back of the card.

³ The external card number is placed in the bottom right-hand corner for iCLASS 13.56 MHz and in the bottom center for 125 kHz Proximity on the back of the card.

⁴ MIFARE Classic UID length is by default 4 bytes, 7 bytes for MIFARE DESFire EV1.

* The composite construction is recommended for all cards with over-laminate applied. Consult with the printer manufacturer prior to ordering.

Embeddable iCLASS Credentials

iCLASS Embeddable Card - 211

iCLASS cards can be ordered either with both SIO and iCLASS programming or iCLASS programming only.

Ensure each required option has been checked with the appropriate choice to fulfill a completed order form.

Base Model **211 Composite 40% Polyester / PVC***

iCLASS Memory Size and Allocation (select one option)

- 0** - 2k Bits (256 Bytes) with 2 Application Areas
- 3** - 32k Bits (4K Bytes) Application areas 16k/2+16k/1
- 4** - 32k Bits (4K Bytes) Application areas 16k/16+16k/1

Programming (select one option)

- HP** - Programmed with Security Identity Object (SIO) and standard iCLASS Access Control Application (Recommended)¹
- C** - Configured, Non-Programmed iCLASS. Programming Information Not Required
- P** - Programmed iCLASS. Specify Programming Information

Front Packaging (select one option)

- G** - Plain White with Gloss Finish
- C** - Custom Artwork/Contact Module with Gloss Finish – Specify Custom Artwork/Contact Module Number¹

Back Packaging (select one option)

- G** - Plain White with Gloss Finish²
- C** - Custom Artwork with Gloss Finish – Specify Custom Artwork Number¹
- 1** - Plain White with Gloss Finish with Magnetic Stripe²
- 3** - Custom Artwork with Gloss Finish with Magnetic Stripe - Specify Custom Artwork Number¹

Card Numbering³ (select one option)

- N** - No External Card Numbering
- A** - Sequential Matching Internal/External (Engraved)
- B** - Sequential Internal/Sequential Non-Matching External (Laser Engraved)
- C** - Random Internal/Non-Matching Sequential External (Laser Engraved)

Slot Punch⁴

- B** - No Slot Punch. This card can be slotted horizontally, Printed Horizontal Slot Indicators
- H** - Horizontal Slot Punch
- N** - No Slot Punch (Printed location of vertical slot punch will remain)
- V** - Vertical Slot Punch

Option - Custom Artwork¹

_____ (Specify Artwork Number - Refer to the Custom Artwork Forms for new Artwork)

Enter your final card options from check boxes above. Example: 2111CGGNN

Final Part Number	211							-	(Options #)
-------------------	-----	--	--	--	--	--	--	---	-------------

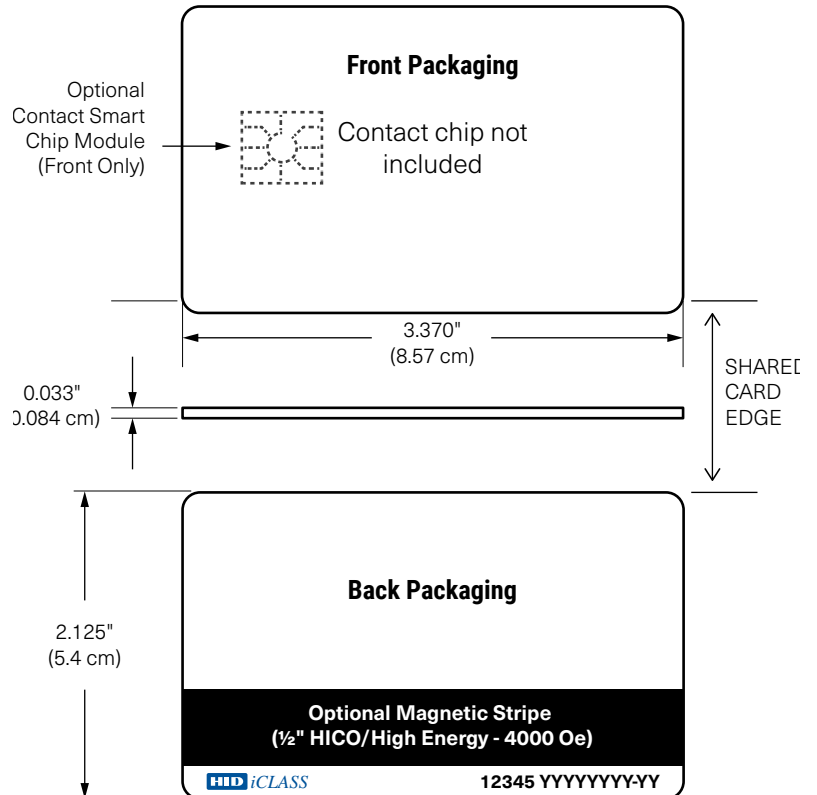



iCLASS Card Programming Information

Format Number (e.g. H10301)	Field Name(s) e.g. Facility Code	Value	QTY	Encoded Start Number	Encoded Stop Number
Bit Numbers (e.g. 26 bit)				Printed Start Number	Printed Stop Number

PIN: Sequential: Start# _____ Random: Length _____

Special Instructions: _____

For Contact Smart Chip selection, contact your Regional Sales Representative. Standard configuration does not include a contact smart chip module.

- ¹ For new artwork files, contact Customer Service for custom artwork number, lead times and cost.
- ² Cards ordered with plain white front and back packaging, with no HID artwork or with custom artwork, will still have a small HID logo and reference number printed in the lower left-hand corner and a slot punch target printed on the back of the card.
- ³ The external card number is placed in the bottom right-hand corner on the back of the card.
- ⁴ Cards are provided with an optional vertical slot punch at no additional charge. Some video imaging printers cannot accommodate pre-slot punched cards.
- * The composite construction is recommended for all cards that will have an over-laminate applied. Consult with the printer manufacturer prior to ordering.

iCLASS + Prox Embeddable Card - 213

iCLASS + Prox cards can be ordered either with both SIO and iCLASS programming or iCLASS programming only, a composite fee applies to this card.

Ensure each required option has been checked with the appropriate choice to fulfill a completed order form.

Base Model **213 Composite 40% Polyester / PVC***

iCLASS Memory Size and Allocation (select one option)

- 0** - 2k Bits (256 Bytes) with 2 Application Areas
- 3** - 32k Bits (4K Bytes) Application areas 16k/2+16k/1
- 4** - 32k Bits (4K Bytes) Application areas 16k/16+16k/1

Programming (select one option)

- HP** - Programmed with Security Identity Object (SIO), and standard iCLASS access control application, 25 kHz Unprogrammed⁵
- HB** - Programmed with Security Identity Object (SIO), and standard iCLASS access control application, 125 kHz programmed with HID Prox or Indala format.
- P** - Programmed with standard iCLASS access control application, 125 kHz HID Prox unprogrammed for use with iCLASS SE Encoder.
- B** - 125 kHz Programmed with HID Prox or Indala format, iCLASS programmed with standard access control application.
- C** - iCLASS Unprogrammed, for use with iCLASS SE Encoder, HID Prox unprogrammed for use with iCLASS SE Encoder
- A** - iCLASS Unprogrammed, for use with iCLASS SE Encoder, 125 kHz programmed with HID Prox or Indala format.
- M** - iCLASS Programmed, HITAG2 blank.
- I** - iCLASS configured field programmable, HITAG2 blank.

Front Packaging (select one option)

- G** - Plain White with Gloss Finish
- C** - Custom Artwork/Contact Module with Gloss Finish – Specify Custom Artwork/Contact Module Number¹

Back Packaging (select one option)

- G** - Plain White with Gloss Finish²
- C** - Custom Artwork with Gloss Finish – Specify Custom Artwork Number¹
- 1** - Plain White with Gloss Finish with Magnetic Stripe²
- 3** - Custom Artwork with Gloss Finish with Magnetic Stripe - Specify Custom Artwork Number¹

iCLASS Card Numbering³ (select one option)

- N** - No External Card Numbering
- A** - Sequential Matching Internal/External (Laser Engraved)
- B** - Sequential Internal/Sequential Non-Matching External (Laser Engraved)
- C** - Random Internal/Non-Matching Sequential External (Laser Engraved)

Slot Punch⁴

- N** - No Slot Punch. (Printed location of vertical slot punch will remain)
- V** - Vertical Slot Punch

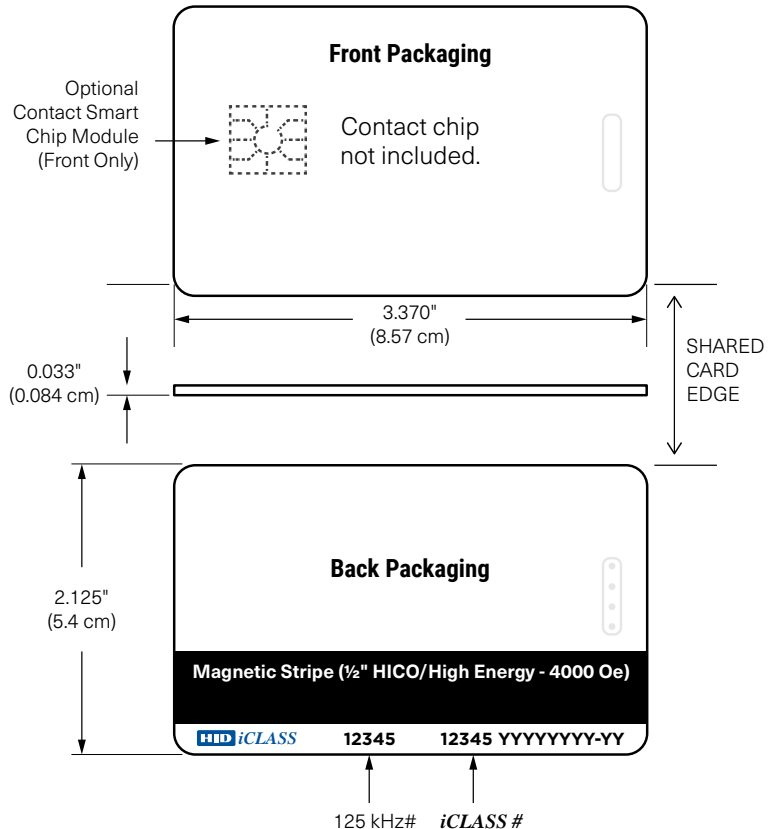

12345 = Card ID Number
YYYYYYYY-YY = Sales Order Number



125 kHz Card Numbering³ (select one option)

- N** - No External Card Numbering
- A** - Sequential Matching Internal/External (Laser Engraved)
- B** - Sequential Internal/Sequential Non-Matching External (Laser Engraved)
- C** - Random Internal/Non-Matching Sequential External (Laser Engraved)

Option - Custom Artwork¹

_____ (Specify Artwork Number - Refer to the Custom Artwork Forms for new Artwork)

Enter your final card options from check boxes above. Example: 2133CGGNNN

Final Part Number	213						-	(Options #)
-------------------	-----	--	--	--	--	--	---	-------------

iCLASS Programming Information

Format Number (e.g. H10301)	Field Name(s) e.g. Facility Code	Value	QTY	Encoded Start Number	Encoded Stop Number
Bit Numbers (e.g. 26 bit)				Printed Start Number	Printed Stop Number

PIN: Sequential: Start# _____ Random: Length _____

125 kHz Programming Information

Format Number (e.g. H10301)	Field Name(s) e.g. Facility Code	Value	QTY	Encoded Start Number	Encoded Stop Number
Bit Numbers (e.g. 26 bit)				Printed Start Number	Printed Stop Number

Special Instructions: _____

For Contact Smart Chip selection, contact your Regional Sales Representative. Standard configuration does not include a contact smart chip module.

- ¹ For new artwork files, contact Customer Service for custom artwork number, lead times and cost.
- ² Cards ordered with plain white front and back packaging, with no HID artwork or with custom artwork, will still have a small HID logo and reference number printed in the lower left-hand corner and a slot punch target printed on the back of the card.
- ³ The external card number is placed in the bottom right-hand corner for iCLASS 13.56 MHz and in bottom center for 125 kHz Prox on the back of the card.
- ⁴ Cards are provided with an optional vertical slot punch at no additional charge. Some video imaging printers cannot accommodate pre-slot punched cards.
- ⁵ Secure Identity Object (SIO) Programming is not mandatory but highly recommended. If SIO programming is not selected the letter H should be left out from Final Part Number, for example: 2130PGGNNN.
- * The composite construction is recommended for all cards that will have an over-laminate applied. Consult with the printer manufacturer prior to ordering.

iCLASS + Other HF Embeddable Card - 243

The iCLASS with MIFARE or MIFARE DESFire embeddable smart card offers multiple High Frequency technologies to simplify card issuance for diverse systems or migration projects. Add new applications while leveraging your investment in existing access control systems. Personalize the card with a photo ID, magnetic stripe, barcode, or anti-counterfeiting element.

Ensure each required option has been checked with the appropriate choice to fulfill a completed order form.

Base Model **243 Composite 40% Polyester / PVC***

iCLASS Memory Size and Allocation (select one option)

- 0** - 2k Bits (256 Bytes) with 2 Application Areas
(only available with MIFARE CLASSIC 1K)
- 3** - 32k Bits (4K Bytes) Application areas 16k/2+16k/1
- 4** - 32k Bits (4K Bytes) Application areas 16k/16+16k/1

Card Programming (select one option)

- J** - iCLASS programmed with Security Identity Object (SIO) and iCLASS standard access control application, 2nd technology programmed with Security Identity Object (SIO).
- H** - iCLASS programmed with Security Identity Object (SIO) and iCLASS standard access control application, 2nd technology unprogrammed.
- B** - iCLASS programmed with iCLASS standard access control application, 2nd Technology programmed with HID MIFARE (MIFARE Classic) or custom (MIFARE DESFire).
- P** - iCLASS programmed with iCLASS standard access control application, 2nd Technology unprogrammed.
- C** - Unprogrammed iCLASS, for use with iCLASS SE Encoder, Non-programmed 2nd Technology.
- A** - iCLASS unprogrammed, for use with iCLASS SE Encoder, 2nd Technology programmed with HID MIFARE (MIFARE Classic) or custom (MIFARE DESFire).

2nd High Frequency Technology (select one option)

- M** - MIFARE Classic 1K Bytes (only available with iCLASS 2k bits)
- N** - MIFARE 4K Bytes

Front Packaging (select one option)

- G** - Plain White with Gloss Finish
- C** - Custom Artwork with Gloss Finish – Specify Custom Artwork Number¹

Back Packaging (select one option)

- G** - Plain White with Gloss Finish²
- C** - Custom Artwork with Gloss Finish – Specify Custom Artwork Number¹
- 1** - Plain White with Gloss Finish with Magnetic Stripe²
- 3** - Custom Artwork with Gloss Finish with Magnetic Stripe - Specify Custom Artwork Number¹

iCLASS Card Numbering³ (select one option)

- N** - No External Card Numbering
- A** - Sequential Matching Internal/External (Laser Engraved)
- B** - Sequential Internal/Sequential Non-Matching External (Laser Engraved)
- C** - Random Internal/Non-Matching Sequential External (Laser Engraved)

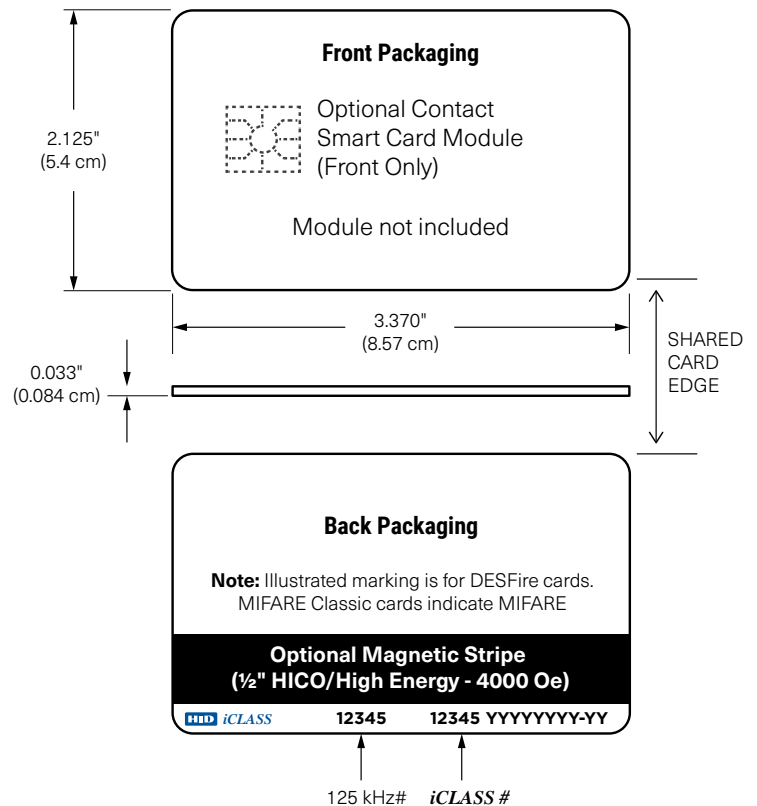



Slot Punch

IMPORTANT: Dual High Frequency credentials do not allow a slot punch due to the antenna design. HID recommends using a badge holder to attach this card to a lanyard or badge clip.

N - No Slot Punch.

2nd High Frequency Technology Card Numbering³ (select one option)

- N - No External Card Numbering
- A - Sequential Matching Internal/External (Laser Engraved)
- B - Sequential Internal/Sequential Non-Matching External (Laser Engraved)
- C - Random Internal/Non-Matching Sequential External(Laser Engraved)

Option - Custom Artwork¹

_____ (Specify Artwork Number - Refer to the Custom Artwork Forms for new Artwork)

Enter your final card options from the above selections. Example: 243PNGGNNN

Final Part Number	243							N		-	(Options #)
-------------------	-----	--	--	--	--	--	--	---	--	---	-------------

iCLASS Programming Information

Format Number (e.g. H10301)	Field Name(s) e.g. Facility Code	Value	QTY	Encoded Start Number	Encoded Stop Number
Bit Numbers (e.g. 26 bit)				Printed Start Number	Printed Stop Number
ICE Number					

PIN: Sequential: Start# _____ Random: Length _____

2nd 13.56 MHz Programming Information

Format Number (e.g. H10301)	Field Name(s) e.g. Facility Code	Value	QTY	Encoded Start Number	Encoded Stop Number
Bit Numbers (e.g. 26 bit)				Printed Start Number	Printed Stop Number

Special Instructions: _____

¹ For new artwork files, contact Customer Service for custom artwork number, lead times and cost.

² Cards ordered with plain white front and back packaging, with no HID artwork or with custom artwork, will still have a small HID logo and reference number printed in the lower left-hand corner and a slot punch target printed on the back of the card.

³ The external card number is placed in the bottom right-hand corner for iCLASS 13.56 MHz and in the bottom center for 125 kHz Proximity on the back of the card.

* The composite construction is recommended for all cards that will have an over-laminate applied. Consult with the printer manufacturer prior to ordering.

iCLASS + Other 13.56 MHz + Prox Embeddable Card - 263

The iCLASS + Prox with MIFARE or MIFARE DESFire embeddable smart card offers multiple High & Low Frequency technologies to simplify card issuance for diverse systems or migration projects. Add new applications while leveraging your investment in existing access control systems. Personalize the card with a photo ID, magnetic stripe, barcode, or anti-counterfeiting element.

Ensure each required option has been checked with the appropriate choice to fulfill a completed order form.

Base Model **263 Composite 40% Polyester / PVC***

iCLASS Memory Size and Allocation (select one option)

- 0** - 2k Bits (256 Bytes) with 2 Application Areas (only available with MIFARE CLASSIC 1K)
- 3** - 32k Bits (4K Bytes) Application areas 16k/2+16k/1
- 4** - 32k Bits (4K Bytes) Application areas 16k/16+16k/1

Card Programming (select one option)

- J** - iCLASS programmed with Security Identity Object (SIO) and iCLASS standard access control application, 2nd technology programmed with Security Identity Object (SIO).
- H** - iCLASS programmed with Security Identity Object (SIO) and iCLASS standard access control application, 2nd technology unprogrammed.
- K** - iCLASS programmed with Secure Identity Object (SIO) and iCLASS standard access control application, 2nd Technology programmed with HID MIFARE (MIFARE Classic) or custom (MIFARE DESFire).
- B** - iCLASS programmed with iCLASS standard access control application, 2nd Technology programmed with HID MIFARE (MIFARE Classic) or custom (MIFARE DESFire).
- P** - iCLASS programmed with iCLASS standard access control application, 2nd Technology unprogrammed.
- C** - iCLASS unprogrammed, for use with iCLASS SE Encoder, 2nd Technology unprogrammed.
- A** - iCLASS unprogrammed, for use with iCLASS SE Encoder, 2nd Technology programmed with HID MIFARE (MIFARE Classic) or custom (MIFARE DESFire).

2nd High Frequency Technology (select one option)

- M** - MIFARE Classic 1K Bytes (only available with iCLASS 2k bits)
- N** - MIFARE 4K Bytes

3rd Low Frequency Technology (select one option)

- P** - Programmed with HID Prox or Indala format
- C** - Programmed with Indala CX (Casi Prox)
- N** - Unprogrammed HID Prox, for use with iCLASS SE Encoder

Front Packaging (select one option)

- G** - Plain White with Gloss Finish
- C** - Custom Artwork with Gloss Finish – Specify Custom Artwork Number¹

Back Packaging (select one option)

- G** - Plain White with Gloss Finish²
- C** - Custom Artwork with Gloss Finish – Specify Custom Artwork Number¹
- 1** - Plain White with Gloss Finish with Magnetic Stripe²
- 3** - Custom Artwork with Gloss Finish with Magnetic Stripe - Specify Custom Artwork Number¹

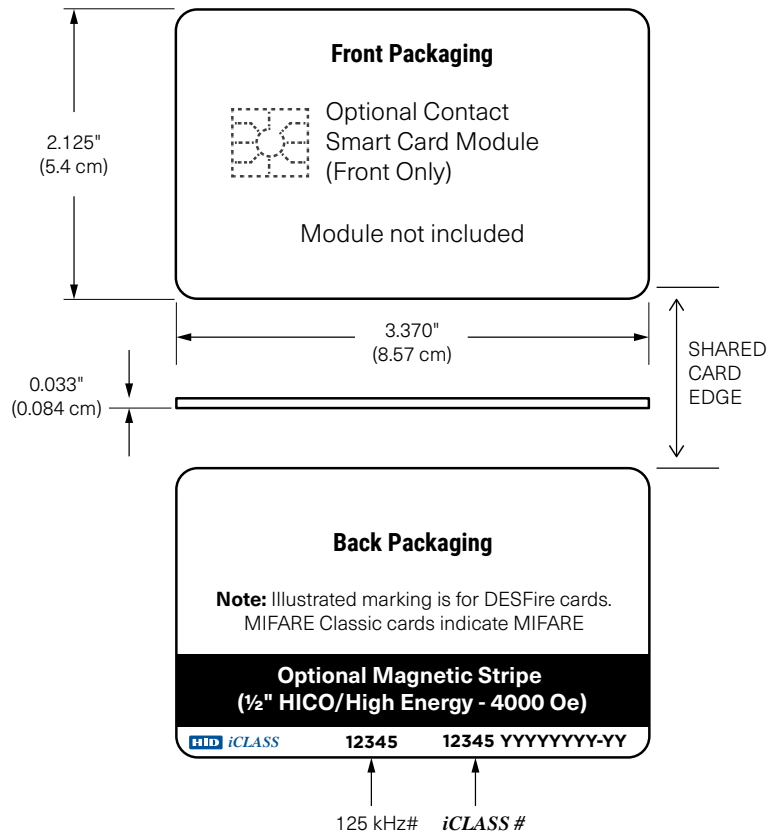



iCLASS Card Numbering³ (select one option)

- N - No External Card Numbering
- A - Sequential Matching Internal/External (Laser Engraved)
- B - Sequential Internal/Sequential Non-Matching External (Laser Engraved)
- C - Random Internal/Non-Matching Sequential External (Laser Engraved)

Slot Punch

IMPORTANT: Dual High Frequency credentials do not allow a slot punch due to the antenna design. HID recommends using a badge holder to attach this card to a lanyard or badge clip.

- N - No Slot Punch.

2nd High Frequency Technology Card Numbering³ (select one option)

- N - No External Card Numbering
- A - Sequential Matching Internal/External (Laser Engraved)
- B - Sequential Internal/Sequential Non-Matching External (Laser Engraved)
- C - Random Internal/Non-Matching Sequential External(Laser Engraved)

3rd High Frequency Technology Card Numbering³ (select one option)

- N - No External Card Numbering
- A - Sequential Matching Internal/External (Laser Engraved)
- B - Sequential Internal/Sequential Non-Matching External (Laser Engraved)
- C - Random Internal/Non-Matching Sequential External(Laser Engraved)

Option - Custom Artwork¹

_____ (Specify Artwork Number - Refer to the Custom Artwork Forms for new Artwork)

Enter your final card options from the above selections. Example: 2634JNPPGANN

Final Part Number	263				P			N		-	(Options #)
-------------------	-----	--	--	--	---	--	--	---	--	---	-------------

iCLASS 13.56 MHz Programming Information

Format Number (e.g. H10301)	Field Name(s) e.g. Facility Code	Value	QTY	Encoded Start Number	Encoded Stop Number
Bit Numbers (e.g. 26 bit)				Printed Start Number	Printed Stop Number
ICE Number					

PIN: Sequential: Start# _____ Random: Length _____



2nd 13.56 MHz Programming Information

Format Number (e.g. H10301)	Field Name(s) e.g. Facility Code	Value	QTY	Encoded Start Number	Encoded Stop Number
Bit Numbers (e.g. 26 bit)				Printed Start Number	Printed Stop Number

Special Instructions:

125 kHz Card Programming Information

Format Number (e.g. H10301)	Field Name(s) e.g. Facility Code	Value	QTY	Encoded Start Number	Encoded Stop Number
Bit Numbers (e.g. 26 bit)				Printed Start Number	Printed Stop Number

Special Instructions:

¹ For new artwork files, contact Customer Service for custom artwork number, lead times and cost.

² Cards ordered with plain white front and back packaging, or custom artwork, will still have a small HID logo  and reference number printed in the lower left-hand corner and a slot punch target printed on the back of the card.

³ The external card number is placed in the bottom right-hand corner for iCLASS 13.56 MHz and MIFARE while it is in the bottom center for 125 kHz Proximity on the back of the card.

* The composite construction is recommended for all cards with over-laminate applied. Consult with the printer manufacturer prior to ordering.



For Contact Smart Chip selection, contact your Regional Sales Representative. Standard configuration does not include a contact smart chip module.

- ¹ For new artwork files, contact Customer Service for custom artwork number, lead times and cost.
- ² Cards ordered with plain white front and back packaging, with no HID artwork or with custom artwork, will still have a small HID logo  and reference number printed in the lower left-hand corner and a slot punch target printed on the back of the card.
- ³ The external card number is placed in the bottom right-hand corner on the back of the card.
- ⁴ Cards are provided with an optional vertical slot punch at no additional charge. Some video imaging printers cannot accommodate pre-slot punched cards. Consult with the printer manufacturer prior to ordering.
- * The composite construction is recommended for all cards that will have an over-laminate applied.

Smart DuoProx® II Card - 1598

Ensure each required option has been checked with the appropriate choice to fulfill a completed order form.

Base Model **1598 Composite 40% Polyester / PVC***

Programming (select one option)

- L** - Programmed, Low Frequency (125 kHz).
Specify Programming Information.
- N** - Non-Programmed, Low Frequency (125 kHz).
Programming Information Not Required.

Front Packaging (select one option)

- G** - Plain White with Gloss Finish
- C** - Custom Artwork with Gloss Finish –
Specify Custom Artwork Number¹

Back Packaging (select one option)

- G** - Plain White PVC with Gloss Finish²
- C** - Custom Artwork with Gloss Finish –
Specify Custom Artwork Number^{1,2}

Card Numbering³ (select one option)

- N** - No External Card Numbering
- A** - Sequential Matching Internal/External (Engraved)
- B** - Sequential Internal/Sequential Non-Matching External (Engraved)
- C** - Random Internal/Non-Matching Sequential External (Engraved)

Slot Punch⁴ (select one option)

- N** - No Slot Punch (Printed location of vertical slot punch will remain)
- V** - Vertical Slot Punch

Option - Custom Artwork¹

- _____ (Specify Artwork Number - Refer to the Custom Artwork Forms for new Artwork)

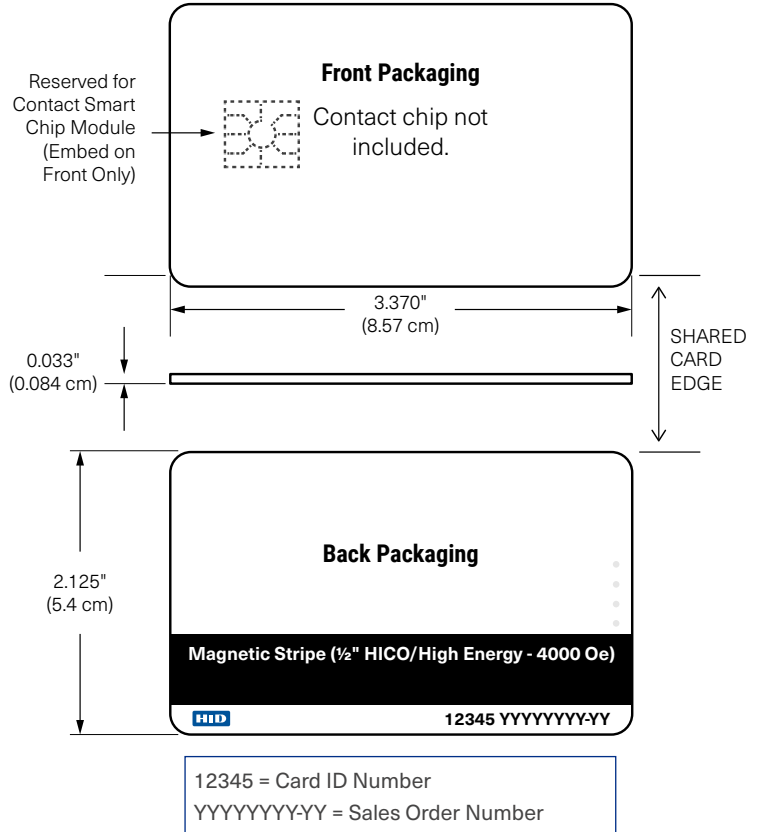

Enter your final card options from check boxes above. Example: 1598LGGAN

Final Part Number	1598						-	(Optional Artwork #)
-------------------	------	--	--	--	--	--	---	----------------------

125 kHz Card Programming Information

Format Number (e.g. H10301)	Field Name(s) e.g. Facility Code	Value	QTY	Encoded Start Number	Encoded Stop Number
Bit Numbers (e.g. 26 bit)				Printed Start Number	Printed Stop Number

Special Instructions: _____

For Contact Smart Chip selection, contact your Regional Sales Representative. Standard configuration does not include a contact smart chip module.



- ¹ For new artwork files, contact Customer Service for custom artwork number, lead times and cost.
- ² Cards ordered with plain white front and back packaging, with no HID artwork or with custom artwork, will still have a small HID logo  and reference number printed in the lower left-hand corner and a slot punch target printed on the back of the card.
- ³ The external card number is placed in the bottom right-hand corner on the back of the card.
- ⁴ Cards are provided with an optional vertical slot punch at no additional charge. Some video imaging printers cannot accommodate pre-slot punched cards. Consult with the printer manufacturer prior to ordering.
- * The composite construction is recommended for all cards that will have an over-laminate applied.

Embeddable MIFARE Classic and MIFARE DESFire Credentials

MIFARE Embeddable Card - 345 / 1436 / 1446

Encompasses the industry's broadest range of open standard contactless smart card products. Provides the memory structure and capacity to store multiple applications on a single credential. All MIFARE Classic cards can be ordered with or without SIO encoding.

Use of a 1430, 1440, 1436, or 1446 for SIO encoding using the CP1000 will consume a chargeable credit.

Ensure each required option has been checked with the appropriate choice to fulfill a completed order form.

MIFARE Classic cards with SIO encoding (Recommended)

- 3450 (1K) Composite 40% Polyester / PVC*
- 3456 (4K) Composite Polyester 40% / PVC*

Programming* (select one option)

- P** - Programmed with Security Identity Object (SIO) for MIFARE Classic
- V** - Unprogrammed Secure Identity object (SIO), for MIFARE Classic, for use with iCLASS SE Encoder.

OR MIFARE Classic Cards without SIO encoding

- 1436 (1K) Composite 40% Polyester / PVC*
- 1446 (4K) Composite Polyester 40% / PVC*

Programming (select one option)

- M** - Programmed HID MIFARE6 access control application
- N** - Unprogrammed MIFARE Classic for use with iCLASS SE Encoder (custom or HID)
- S** - Custom programmed MIFARE Classic, requires custom part number

* A marker is placed in sector 6 and will not be available for other data

Front Packaging (select one option)

If Custom Artwork is desired, specify Custom Artwork Number below¹

- E** - Contact Module Embeddable Plain Gloss White Finish

Back Packaging (select one option)

- G** - Plain White with Gloss Finish²
- 1** - Plain White with Gloss Finish with Magnetic Stripe²
- C** - Custom Artwork with Gloss Finish - Specify Custom Artwork Number^{1,2}
- 3** - Custom Artwork with Gloss Finish with Magnetic Stripe Specify Custom Artwork Number^{1,2}

Card Numbering³ (select one option)

- Z** - Reversed UID (CSN) Decimal card numbering only (Laser Engraved)⁴
- N** - No External Card Numbering
- A** - Sequential Matching Internal/External (Laser Engraved)⁴
- B** - Sequential Internal/Sequential Non-Matching External (Laser Engraved)⁴
- C** - Random Internal/Non-Matching Sequential External (Laser Engraved)⁴

Slot Punch⁵ (select one option)

- N** - No Slot Punch (Printed location of vertical slot punch will remain)
- V** - Vertical Slot Punch

Option - Custom Artwork¹

- _____ (Specify Artwork Number - Refer to the Custom Artwork Forms for new Artwork)

Enter your final card options from check boxes above. Example: 1430NEGNN

Final Part Number			E					-	(Options #)
-------------------	--	--	----------	--	--	--	--	---	-------------

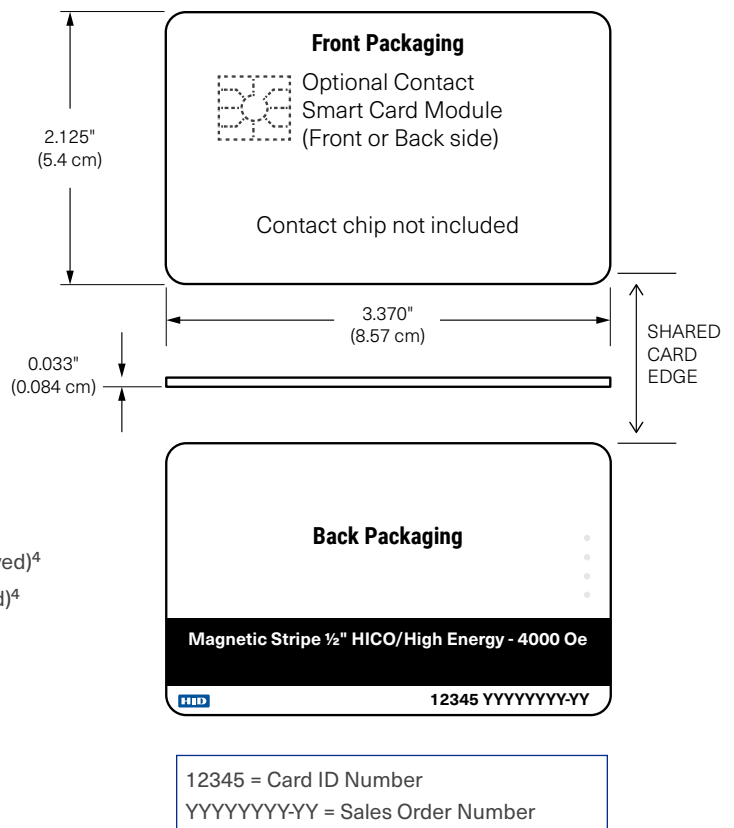



13.56 MHz Card Programming Information

Format Number (e.g. H10301)	Field Name(s) e.g. Facility Code	Value	QTY	Encoded Start Number	Encoded Stop Number
Bit Numbers (e.g. 26 bit)				Printed Start Number	Printed Stop Number

Special Instructions:

For Contact Smart Chip selection, contact your Regional Sales Representative. Standard configuration does not include a contact smart chip module.

- ¹ For new artwork files, contact Customer Service for custom artwork number, lead times, and cost.
- ² Cards ordered with plain white front and back packaging, with no HID artwork or with custom artwork, will still have a small HID logo  and reference number printed in the lower left-hand corner and a slot punch target printed on the back of the card.
- ³ The external card number is placed in the bottom right-hand corner on the back of the card on Prox Format Programming only. Permanent Unique MIFARE 32 Bit serial # cannot be printed on cards.
- ⁴ When printed, by default the number is encoded MSB (most significant byte) -> LSB (least significant byte).
- ⁵ Cards are provided with an optional slot punch at no additional charge. Some video imaging printers cannot accommodate pre-slot punched cards. Consult with the printer manufacturer prior to ordering.
- ⁶ Includes a permanent Unique MIFARE 32 Bit Serial number.
- * The composite construction is recommended for all cards with over-laminate applied.

MIFARE DESFire Embeddable Card - 375 / 1456

Based on open global standards for security, and is interoperable with existing MIFARE DESFire EV1 infrastructures. All MIFARE DESFire EV1 cards can be order either with or without SIO encoding. Use of a 1450 or 1456 for SIO encoding using the CP1000 will consume a chargeable credit. Ensure each required option has been checked with the appropriate choice to fulfill a completed order form.

Card with SIO encoding

3750 Composite 40% Polyester / PVC*

MIFARE DESFire EV1 Memory Size

C - 8K Bytes MIFARE DESFire EV1

Programming

- P** - Programmed Security Identity Object (SIO) for MIFARE DESFire EV1
- V** - Unprogrammed Secure Identity object (SIO) for DESFire EV1, for use with iCLASS SE Encoder (SIO)

OR Card without SIO encoding

1456 Composite 40% Polyester / PVC*

MIFARE DESFire EV1 Memory Size

C - 8K Bytes MIFARE DESFire EV1

Programming (select one option)

- N** - Unprogrammed 13.56 MHz DESFire EV1 for use with iCLASS SE Encoder (custom)
- S** - Custom MIFARE DESFire EV1 programming - requires custom part number

Front Packaging (select one option)

If Custom Artwork is desired, specify Custom Artwork Number below¹

E - Contact Module Embeddable Plain Gloss White Finish

Back Packaging (select one option)

- G** - Plain White with Gloss Finish²
- 1** - Plain White with Gloss Finish with Magnetic Stripe²
- C** - Custom Artwork with Gloss Finish - Specify Custom Artwork Number^{1,2}
- 3** - Custom Artwork with Gloss Finish with Magnetic Stripe - Specify Custom Artwork Number¹

Card Numbering³ (select one option)

- N** - No External Card Numbering
- A** - Sequential Matching Internal/External (Laser Engraved)⁴
- B** - Sequential Internal/Sequential Non-Matching External (Laser Engraved)⁴
- C** - Random Internal/Non-Matching Sequential External (Laser Engraved)⁴
- Z** - Reversed UID (CSN) Decimal card numbering only (Laser Engraved)⁴

Slot Punch⁵ (select one option)

- N** - No Slot Punch (Printed location of vertical slot punch will remain)
- V** - Vertical Slot Punch

Option - Custom Artwork¹

_____ (Specify Artwork Number - Refer to the Custom Artwork Forms for new Artwork)

Enter your final card options from check boxes above. Example: 1456CNEGNN

Final Part Number	1456	C		E			-	(Options #)
-------------------	------	---	--	---	--	--	---	-------------

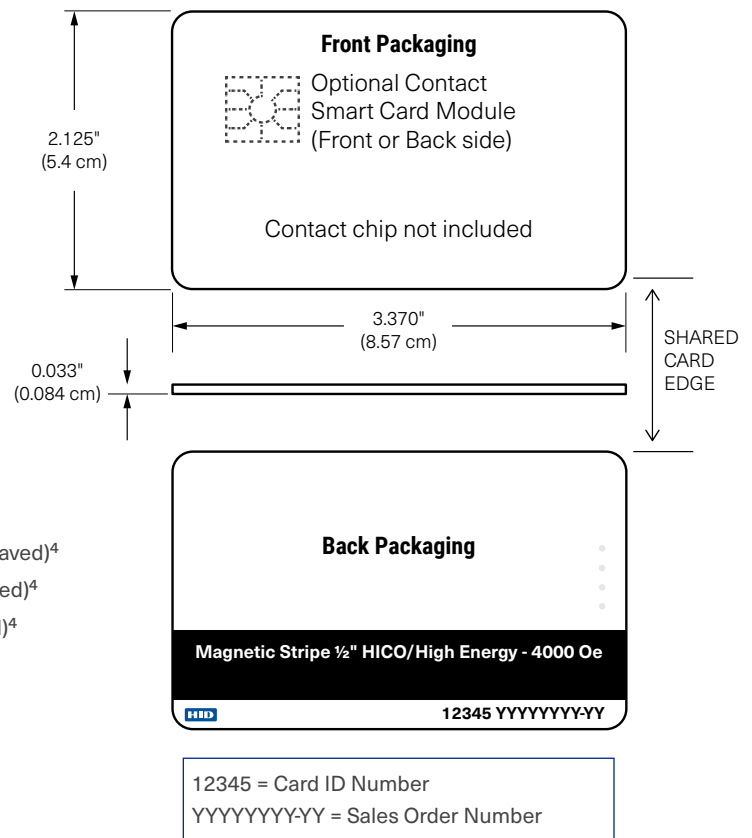



13.56 MHz Card Programming Information

Format Number (e.g. H10301)	Field Name(s) e.g. Facility Code	Value	QTY	Encoded Start Number	Encoded Stop Number
Bit Numbers (e.g. 26 bit)				Printed Start Number	Printed Stop Number

Special Instructions:

For Contact Smart Chip selection, contact your Regional Sales Representative. Standard configuration does not include a contact smart chip module.

- ¹ For new artwork files, contact Customer Service for custom artwork number, lead times, and cost.
- ² Cards ordered with plain white front and back packaging, with no HID artwork or with custom artwork, will still have a small HID logo  and reference number printed in the lower left-hand corner and a slot punch target printed on the back of the card.
- ³ The external card number is placed in the bottom right corner on the back of the card on Prox Format Programming only. Permanent Unique MIFARE 56 Bit serial # cannot be printed on cards.
- ⁴ When printed, by default the number is encoded MSB (most significant byte) -> LSB (least significant byte).
- ⁵ Cards are provided with optional slot punch at no additional charge. Some video imaging printers cannot accommodate pre-slot punched cards. Consult the printer manufacturer prior to ordering.
- ⁶ Includes a permanent Unique MIFARE 56 Bit Serial number.

MIFARE + Prox Embeddable Card - 355 / 1437 / 1447

Encompasses the industry's broadest range of open standard contactless smart card products. Provides the memory structure and capacity to store multiple applications on a single credential with the addition of Proximity technology for easier migration. All MIFARE Classic + Prox cards can be ordered with or without SIO encoding. Use of a 1431, 1441, 1437, or 1447 for SIO encoding using the CP1000 will consume a chargeable credit.

Ensure each required option has been checked with the appropriate choice to fulfill a completed order form.

Ensure each required option has been checked with the appropriate choice to fulfill a completed order form.

MIFARE Classic + Prox card with SIO encoding (Recommended)

- 3550 (1K) Composite 40% Polyester / PVC*
- 3556 (4K) Composite 40% Polyester / PVC*

Programming* (select one option)

- P** - Programmed 13.56 MHz with Security Identity Object (SIO) for MIFARE Classic, unprogrammed 125 kHz HID Prox for use with iCLASS SE Encoder
- R** - Programmed 13.56 MHz Security Identity Object (SIO) for MIFARE Classic, programmed 125 kHz with HID Prox or Indala format
- V** - Unprogrammed 13.56 MHz SIO for MIFARE (for use with iCLASS SE Encoder (SIO), unprogrammed 125 kHz HID Prox for use with iCLASS SE Encoder

* A marker is placed in sector 6 and will not be available for other data

MIFARE Classic + Prox card without SIO encoding

- 1437 (1K) Composite 40% Polyester / PVC*
- 1447 (4K) Composite 40% Polyester / PVC*

Programming (select one option)

- L** - Programmed 125 kHz with HID Prox or Indala Format6, unprogrammed 13.56 MHz MIFARE Classic (for use with iCLASS SE Encoder custom or HID)
- M** - Programmed 13.56 MHz HID MIFARE6 access control application, unprogrammed 125 kHz HID Prox for use with iCLASS SE Encoder
- B** - Programmed 13.56 MHz with HID MIFARE6 access control application, programmed 125 kHz with HID Prox or Indala format
- N** - Unprogrammed 13.56 MHz MIFARE (for use with SE Encoder custom or HID), unprogrammed 125 kHz HID Prox for use with iCLASS SE Encoder
- S** - Custom Programmed 13.56 MHz MIFARE Classic, unprogrammed 125 kHz HID Prox for use with iCLASS SE Encoder, requires custom part number

Front Packaging (select one option)

If Custom Artwork is desired, specify Custom Artwork Number below¹

- E** - Contact Module Embeddable Plain Gloss White Finish

Back Packaging (select one option)

- G** - Plain White with Gloss Finish²
- 1** - Plain White with Gloss Finish with Magnetic Stripe²
- 3** - Custom Artwork with Gloss Finish with Magnetic Stripe - Specify Custom Artwork Number^{1,2}
- C** - Custom Artwork with Gloss Finish - Specify Custom Artwork Number^{1,2}

13.56 MIFARE Card Numbering³ (select one option)

- N** - No External Card Numbering
- A** - Sequential Matching Internal/External (Laser Engraved)⁴
- B** - Sequential Internal/Sequential Non-Matching External (Laser Engraved)⁴
- C** - Random Internal/Non-Matching Sequential External (Laser Engraved)⁴
- Z** - Reversed UID (CSN) Decimal card numbering only (Laser Engraved)⁴

Slot Punch⁵ (select one option)

- N** - No Slot Punch (Printed location of vertical slot punch will remain)
- V** - Vertical Slot Punch

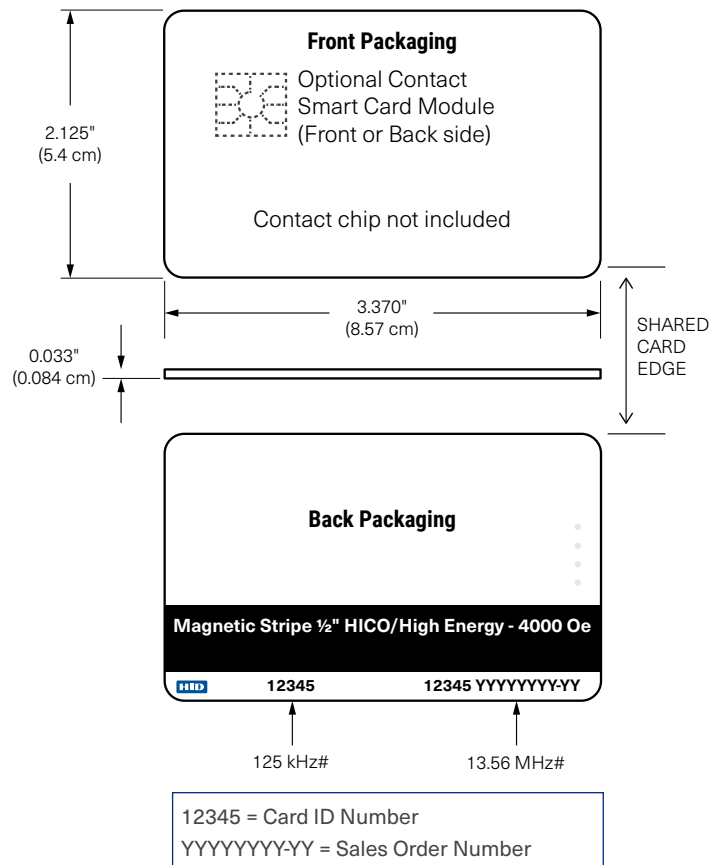



125 kHz Prox Card Numbering³ (select one option)

- N** - No External Card Numbering
- A** - Sequential Matching Internal/External (Laser Engraved)⁴
- B** - Sequential Internal/Sequential Non-Matching External (Laser Engraved)⁴
- C** - Random Internal/Non-Matching Sequential External (Laser Engraved)⁴

Option - Custom Artwork¹

- _____ (Specify Artwork Number - Refer to the Custom Artwork Forms for new Artwork)

Enter your final card options from check boxes above. Example: 1441NEGNNN

Final Part Number			E						-	(Options #)
-------------------	--	--	---	--	--	--	--	--	---	-------------

13.56 MHz Programming Information

Format Number (e.g. H10301)	Field Name(s) e.g. Facility Code	Value	QTY	Encoded Start Number	Encoded Stop Number
Bit Numbers (e.g. 26 bit)				Printed Start Number	Printed Stop Number

125 kHz Programming Information

Format Number (e.g. H10301)	Field Name(s) e.g. Facility Code	Value	QTY	Encoded Start Number	Encoded Stop Number
Bit Numbers (e.g. 26 bit)				Printed Start Number	Printed Stop Number

Special Instructions:	
------------------------------	--

For Contact Smart Chip selection, contact your Regional Sales Representative. Standard configuration does not include a contact smart chip module.

- ¹ For new artwork files, contact Customer Service for custom artwork number, lead times, and cost.
- ² Cards ordered with plain white front and back packaging, with no HID artwork or with custom artwork, will still have a small HID logo and reference number printed in the lower left-hand corner and a slot punch target printed on the back of the card.
- ³ The external card number is placed in the bottom left-hand corner (125 kHz) and in the bottom right-hand corner (13.56 MHz) on the back of the card on Prox Programming only. Permanent unique MIFARE 32 Bit serial # cannot be printed on cards.
- ⁴ When printed, by default the number is encoded MSB (most significant byte) -> LSB (least significant byte).
- ⁵ Cards are provided with an optional slot punch at no additional charge. Some video imaging printers cannot accommodate pre-slot punched cards. Consult with the printer manufacturer prior to ordering.
- ⁶ Includes a permanent Unique MIFARE 32 Bit Serial number.
- * The composite construction is recommended for all cards with over-laminate applied.

MIFARE DESFire + Prox Embeddable Card - 385 / 1457

Based on open global standards for security, and is interoperable with existing MIFARE DESFire infrastructures with the addition of Proximity technology for easier migration. All MIFARE DESFire EV1 cards can be order either with or without SIO encoding. Use of a1451 or 1457 for SIO encoding using the CP1000 will consume a chargeable credit.

Ensure each required option has been checked with the appropriate choice to fulfill a completed order form.

Card with SIO encoding + Prox (Recommended)

- 3850 Composite 40% Polyester / PVC*

MIFARE DESFire EV1 Memory Size

- C** - 8K Bytes DESFire EV1

Programming (select one option)

- P** - Programmed 13.56 MHz with Security Identity Object (SIO) for MIFARE DESFire EV1, unprogrammed 125 kHz HID Prox (for use with iCLASS SE Encoder)
- R** - Programmed 13.56 MHz with Security Identity Object (SIO) for MIFARE DESFire EV1, programmed 125 kHz HID Prox or Indala
- V** - Unprogrammed 13.56 MHz with Secure Identity object (SIO) for MIFARE DESFire EV1 for use with iCLASS SE Encoder (SIO), unprogrammed 125 kHz HID Prox for use with iCLASS SE Encoder.

OR Card without SIO encoding + Prox

- 1457 Composite 40% Polyester / PVC*
*HITAG based cards are not available with composite

MIFARE DESFire EV1 Memory Size

- C** - 8K Bytes DESFire EV1

Programming (select one option)

- L** - Programmed 125 kHz HID Prox or Indala, unprogrammed 13.56 MHz DESFire EV1 for SE Encoder (custom).
- N** - Unprogrammed 13.56 MHz DESFire EV1 for iCLASS SE Encoder (custom), unprogrammed 125 kHz HID Prox for iCLASS SE Encoder.
- S** - Custom programmed 13.56 MHz DESFire EV1, unprogrammed HID Prox for iCLASS SE Encoder, custom part number required
- R** - Custom programmed 13.56 MHz, programmed 125 kHz HID Prox or Indala, custom part number required
- F** - Unprogrammed 13.56 MHz DESFire EV1 for use with iCLASS SE Encoder (custom), unprogrammed HITAG 1
- G** - Custom programmed 13.56 MHz DESFire EV1, unprogrammed HITAG 1, custom part number required

Front Packaging

If Custom Artwork is desired, specify Custom Artwork Number below¹

- E** - Contact Module Embeddable Plain Gloss White Finish

Back Packaging (select one option)

- G** - Plain White with Gloss Finish²
- 1** - Plain White with Gloss Finish with Magnetic Stripe²
- 3** - Custom Artwork with Gloss Finish with Magnetic Stripe - Specify Custom Artwork Number^{1,2}
- C** - Custom Artwork with Gloss Finish - Specify Custom Artwork Number^{1,2}

13.56 MIFARE DESFire Card Numbering³ (select one option)

- N** - No External Card Numbering
- A** - Sequential Matching Internal/External (Engraved)⁴
- B** - Sequential Internal/Sequential Non-Matching External (Engraved)⁴
- C** - Random Internal/Non-Matching Sequential External (Engraved)⁴
- Z** - Reversed UID (CSN) Decimal card numbering only (Laser Engraved)⁴

Slot Punch⁵ (select one option)

- N** - No Slot Punch (Printed location of vertical slot punch will remain)
- V** - Vertical Slot Punch

125 kHz Prox Card Numbering³ (select one option)

- N** - No External Card Numbering
- A** - Sequential Matching Internal/External (Engraved)⁴
- B** - Sequential Internal/Sequential Non-Matching External (Engraved)⁴
- C** - Random Internal/Non-Matching Sequential External (Engraved)⁴

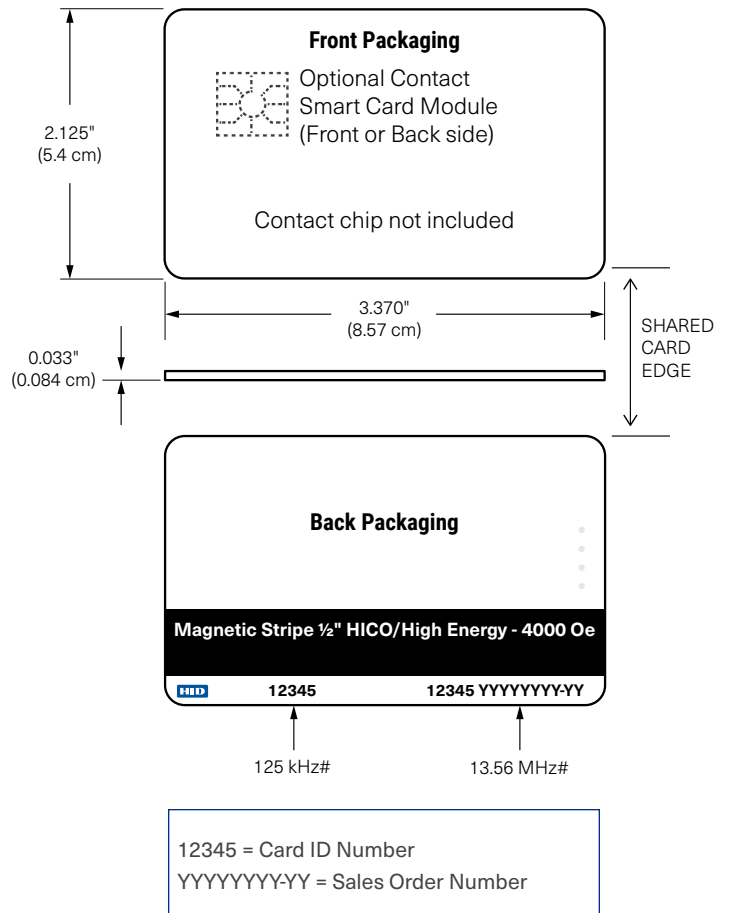



Option - Custom Artwork¹

_____ (Specify Artwork Number - Refer to the Custom Artwork Forms for new Artwork)

Enter your final card options from check boxes above. Example: 1457CNEGNNN

Final Part Number	1457	C		E					-	(Options #)
-------------------	------	---	--	---	--	--	--	--	---	-------------

13.56 MHz Programming Information

Format Number (e.g. H10301)	Field Name(s) e.g. Facility Code	Value	QTY	Encoded Start Number	Encoded Stop Number
Bit Numbers (e.g. 26 bit)				Printed Start Number	Printed Stop Number

125 kHz Programming Information

Format Number (e.g. H10301)	Field Name(s) e.g. Facility Code	Value	QTY	Encoded Start Number	Encoded Stop Number
Bit Numbers (e.g. 26 bit)				Printed Start Number	Printed Stop Number

Special Instructions: _____

For Contact Smart Chip selection, contact your Regional Sales Representative. Standard configuration does not include a contact smart chip module.

- ¹ For new artwork files, contact Customer Service for custom artwork number, lead times, and cost.
- ² Cards ordered with plain white front and back packaging, with no HID artwork or with custom artwork, will still have a small HID logo and reference number printed in the lower left-hand corner and a slot punch target printed on the back of the card.
- ³ The external card number is placed in the bottom left-hand corner (125 kHz) and in the bottom right-hand corner (13.56 MHz) on the back of the card on Prox Programming only. Permanent unique MIFARE 56 Bit serial # cannot be printed on cards.
- ⁴ When printed, by default the number is encoded MSB (most significant byte) -> LSB (least significant byte).
- ⁵ Cards are provided with an optional slot punch at no additional charge. Some video imaging printers cannot accommodate pre-slot punched cards. Consult with the printer manufacturer prior to ordering.
- ⁶ Includes a permanent Unique MIFARE 56 Bit Serial number.
- * The composite construction is recommended for all cards with over-laminate applied.



Revision history

Date	Description	Revision
February 2025	Adds the 40C model to HID Signo PIV Readers. Update to the Seos Card - 500 Slot Punch options.	E.0
February 2025	Updated HID Signo Readers, HID Signo PIV Readers, and the iCLASS SE Readers Accessories Configuration Cards sections. Removed Product Configurator references for Readers. Updated HID Mobile Access to add 5 year subscriptions.	D.9
April 2024	Added Seos Bamboo Card - 574	D.8
April 2024	Updated Selecting the Right Mobile Access Subscription Type table, and added the Activation Based Subscription table. Updated the Ordering Information - Mobile Identities Service table. Various minor updates.	D.7
October 2023	Updated part number details, and added a caveat to the supplemental information needed for ordering Mobile Identities. Updated Credential Marking section.	D.6
August 2023	Added ordering information to upgrade Mobile Identities subscriptions.	D.5
February 2025	Added MIFARE DESFire EV3 Multi-Technology cards. Various minor updates.	D.4
November 2022	Updates Mobile Access Essentials subscription information.	D.3
October 2022	Updates to Mobile Access.	D.2
September 2022	Updates to HID Signo Readers credential profile table and configuration option table. Added the Fingerprint Enrollment USB Reader. Minor updates. Applied new branding. Changed iCLASS Seos to Seos. Added 'X' to selection boxes where there are no selectable options.	D.1
September 2021	Removed HID Signo Fingerprint Enrollment USB Reader.	D.0
August 2021	Updated Technical Support contact information.	C.9
August 2021	Added Signo PIV Readers, Signo Biometric Readers, and MIFARE DESFire EV3 Credentials. Minor updates.	C.8
February 2021	Added Seos Essential Credentials.	C.7
October 2020	Updated Signo Reader Credential Profiles options.	C.6
September 2020	Updated Signo Reader section images and credential options. Updated Mobile Access onboarding URL and Mobile Identities Service Ordering Information section. Added Embeddable Credentials.	C.5
May 2020	Updated HID Signo Readers section. Updated EMEA contact address.	C.4
March 2020	Minor update.	C.3
March 2020	Added Décor BLE model.	C.2
March 2020	Minor updates.	C.1
February 2020	Added HID Signo.	C.0
November 2019	Added Seos Clamshell - 565. Minor updates.	B.9
October 2019	Added Seos Key Fob - 526.	B.8
July 2019	Minor updates.	B.7
June 2019	Minor updates.	B.6
April 2019	Added iCLASS SE Express and Biometric (RB25F) Readers. Added iCLASS Seos 8K with MIFARE Classic or DESFire EV1 Implementation – 5806/5906.	B.5
January 2019	New "Understanding Credentials" section, revised iCLASS SE Encoder section, various minor updates to credential product pages including programming forms.	B.4
October 2018	Updated Mobile Access section.	B.3
September 2018	Updated to include iCLASS SE and multiCLASS SE Bluetooth and OSDP Upgrade Kits.	B.2
August 2018	Removed EOL 282 card. Various minor updates.	B.1
December 2017	Updated Credentials section with information on the HID Global Product Configurator. Various minor updates.	B.0
September 2017	Update to iCLASS SE Biometric and Display.	A.9
August 2017	Update to iCLASS SE Biometric ReaderSupport/Keyset and Configuration Settings.	A.8
July 2017	New iCLASS SE Biometric and Display Readers. Removed EOL iCLASS LCD products.	A.7
June 2017	Updated Mobile Access section.	A.6
June 2017	Removed EOL bioCLASS products.	A.5
June 2017	Updated Mobile Access section.	A.4
February 2017	Removed EOL products, image updates.	A.3
December 2016	Seos 8k options note, added new 522 iCLASS Seos + iCLASS Card. Amended 520 iCLASS + Seos + iCLASS + Prox.	A.2



Date	Description	Revision
September 2016	iCLASS SE U90, wiring connection updates.	A.1
March 2016	Initial release.	A.0



hidglobal.com

For technical support, please visit: <https://support.hidglobal.com>

© 2025 HID Global Corporation/ASSA ABLOY AB.
All rights reserved.
PLT-02630, Rev. E.0

Part of ASSA ABLOY